



kolpa·san

Cenik / Cijenik 2022



kolpa·san

©KOLPA, d.o.o. Metlika, 2022. Vse pravice pridržane. All rights reserved.

Cenik št. 02/2022 za plačilo v EUR.
Cenik velja / cjenik važi od 1.4.2022 do preklica / do opoziva.

Konceptualna kopalnica

Konceptualna kupaonica

Str. 02

Kopalne in masažne kadi

Kade za kupanje i masažne kade

Str. 09

Masažne kabine, parne savne in masažni stebri

Masažne kabine, parne saune i masažni stupovi

Str. 119

Tuš kadi

Tuš kade

Str. 123

Tuš kabine

Tuš kabine

Str. 147

Kopalniško pohištvo

Kupaonski namještaj

Str. 181

Kopalniški dodatki

Kupaonski dodaci

Str. 257



Slike so simbolične. Pravilna razporeditev elementov je v TEHNIČNEM KATALOGU na www.kolpasan.si

Slike su simbolične. Tačan raspored elemenata je u TEHNIČKOM KATALOGU na www.kolpasan.hr



MILO Collection Ferrazzano



Milo bathtub-FS 174 x 75 (188x78)

15



Milo basin 120, 70

199-200



BOUL Collection Ferrazzano



Konceptualna kopalnica
Konceptualna kupaonica

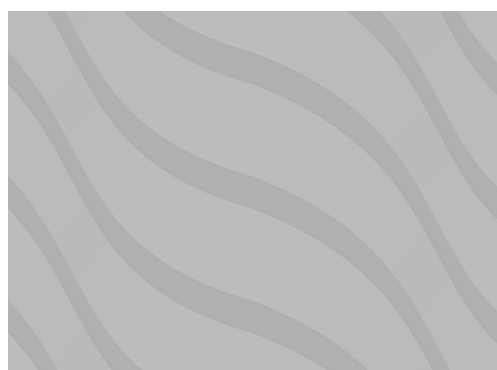

Boul basin Ø 40



202 Boul bathtub-FS 165 x 85



RAMONA Collection



Ramona 160, 80

204



Ramona basin 180 x 80

204



Ramona-FS 180 x 80

PANDORA Collection



Konceptualna kopalnica
Konceptualna kupaonica



Pandora 75, 110, 150

210



Pandora bathtub-FS
173 × 78, 163 × 68

21



Pandora bathtub
180 × 85, 170 × 75

106, 108



Pandora tray 120 × 90, 120 × 80,
100 × 90, 100 × 80, 90 × 90

130



BLANCHE Collection



Blanche 75, 110, 150



215 Blanche-FS 180 x 85



12

EVELIN Collection



Konceptualna kopalnica
Konceptualna kupalnica



Evelin bathtub 170 × 75, 170 × 70,
160 × 70, 150 × 70, 140 × 70 **111**



Evelin tray Q 120 × 90, 120 × 80 **136**



Evelin tray Q 90 × 90, 80 × 80 **136**



Evelin tray R 90 × 90, 80 × 80 **139**



Evelin 55, 65, 80, 65 II, 80 II **249**



Opombe / Primjedbe:

Cene so proizvajalčeve (brez DDV) Cijene su proizvođačeve (bez PDV-a).
Dobavni rok za vse proizvode je do 30 dni od dneva naročila (plačila), oziroma po dogovoru.
Rok isporuke za sve proizvode je do 30 dana od dana narudbe (plaćanja), odnosno po dogovoru.

- **POSEBNE IZVEDBE** tuš kabin, vrat, sten in zaslonov izven standardnih dimenzij:
- program DORSA, ATLAS, PULSAR, SOLE, SQ-LINE, LUNA – 40% dražje od cene po cjeniku
 - program POLARIS, POLARIS FOLD, ANDROMEDA, CALYPSO – 20% dražje od cene po cjeniku.
- Za večja odstopanja se izdelava posebna ponudba.

POSEBNE IZVEDBE tuš kabina, vrata, stranica i zaslona van standardnih dimenzija:

- program DORSA, ATLAS, PULSAR, SOLE, SQ-LINE, LUNA - 40% skuplje od cijene navedene u cjeniku
- program POLARIS, POLARIS FOLD, ANDROMEDA, CALYPSO – 20% skuplje od cijene navedene u cjeniku. Za veća odstupanja izrađuje se posebna ponuda.



Konfigurator
tuš kabin
posebnih
dimenzij

Proizvajalec si pridržuje pravico, da zaradi tehničnega razvoja navedene podatke spremeni kadarkoli.
Proizvođač pridržava pravo, da zbog tehničkog razvoja navedene podatke promjeni u bilo kojem trenutku.

KOLPA, d.o.o. Metlika



Kopalne in masažne kadi

Kade za kupanje i masažne kade







Adam & Eva 195x125	88	Dolores 130x130	34	Libretto-L 160x100	50
Adam & Eva-FS 190x120	16	Dolores 140x140	32	Libretto-D 160x100	52
Atys-FS 180x85	14	Dolores 150x150	30	Libretto-L 170x110	46
Atys 180x85/0	14	Dream-SP 170x75	27	Libretto-D 170x110	48
Atys 200x100	14	Dream-SP 180x80	27	Lux 170x85	25
Atys DUO-FS 174x70	13	Dream-SP-L 170x75	44	Lux-FS 170x85	24
Beatrice-L 170x110(70)	54	Dream-SP-D 170x75	45	Marilyn-FS 180x90	20
Beatrice-D 170x110(70)	56	Dream-SP-L 180x80	44	Milo bathtub-FS 174x75 (188x78)	15
Betty 120x70	86	Dream-SP-D 180x80	45	Mini 100x70	117
Betty 130x70	84	Elektra 160x75	102	Nabucco 190x120	90
Betty 140x70	82	Elektra 170x70	100	Opera Ø 180	28
Betty 150x70	80	Elektra 170x75	98	Pandora bathtub 170x75	108
Betty 160x70	78	Elektra 170x80	96	Pandora bathtub 180x85	106
Betty 170x70	76	Elektra 180x80	94	Pandora bathtub-FS 163x68	21
Betty 170x75	74	Elektra 190x90	92	Pandora bathtub-FS 173x78	21
Betty 170x80	72	Elektra-SP 175x75	26	Ramona bathtub-FS 180x80	13
Betty 180x80	70	Elektra-SP 185x85	26	Royal 120x120	40
Betty 190x90	68	Elektra-SP-L 175x75	42	Royal 130x130	38
Betty 200x90	66	Elektra-SP-D 175x75	43	Samson 180x160	104
Blanche-FS 180x85	12	Elektra-SP-L 185x85	42	Soft 180x80	19
Boul bathtub-FS 165x85	15	Elektra-SP-D 185x85	43	Soft-FS 180x80	18
Calando-L 150x85	62	Evelin bathtub 140x70	111	Tamia 140x70	115
Calando-D 150x85	64	Evelin bathtub 150x70	111	Tamia 140x70/S	115
Calando-L 160x90	58	Evelin bathtub 160x70	111	Tamia 150x70	114
Calando-D 160x90	60	Evelin bathtub 170x70	111	Tamia 160x70	114
Comodo-FS 185x90	17	Evelin bathtub 170x75	110	Tamia 170x70	112
Copelia LIGHT-FS 180x80	11	Figaro 150x70	116	Tamia 170x75	113
Copelia LUX-FS 180x100	11	Figaro 160x80	116	Tamia 180x80	112
Copelia-FS 180x80	10	Figaro 170x75	116	Tristan-FS 197x117	10
Dalia-FS 170x80	22	Gaia 160x160	29		
Divante 140x140	36	Gloria-FS 180x80	12		

Slike so simbolične. Pravilna razporeditev elementov je v TEHNIČNEM KATALOGU na www.kolpasan.si
Slike su simbolične. Tačan raspored elemenata je u TEHNIČKOM KATALOGU na www.kolpasan.hr

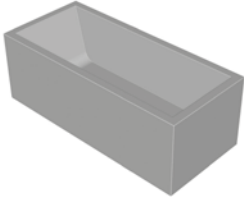
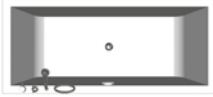
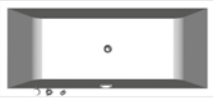

Za kopalne kadi iz Kerrocka in litega sanitarnega akrila.
Za kupaonske kade od Kerrocka i od lijevanog sanitarnog akrila.

Masažni sistemi.
Masažni sustavi.







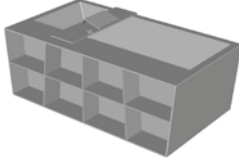

Kopalne in masažne kadi Kade za kupanje i masažne kade		Program: kolpa·san®		
Model	Naziv in dimenzija izdelka Naziv i dimenzije produkta	Opis Opis	EAN koda EAN koda	Cena EUR Cijena EUR
Tristan-FS 197x117				
	Tristan-FS 197x117 -WHITE Tristan-FS 197x117 -BLACK&WHITE	samostoječa ovalna kopalna kad iz KERROCK-a, s kromiranim prelivom, barva zunanjega dela: WHITE, BLACK samostoječa ovalna kada za kupanje od KERROCK-a, s kromiranim prelivom, boja vanjskog dijela: WHITE, BLACK	3838987 815983 3838987 592563	2.152,00 2.661,00
Dodatki za / Dodaci za Tristan-FS 196x117				
	HEADREST COAST	vzglavnik naslon za glavu	3838987 593928	103,00
	Specialno čistilo KOLPA SAN Specialno sredstvo za čiščenje Specialno čistilo ECO SAN Specialno sredstvo za čiščenje KERIL - Specialno čistilo za KERROCK KERIL - Specijalno sredstvo	karton 20 kosov / karton 20 komada (Cena za kos / Cijena na komad 6,20 EUR) karton 20 kosov / karton 20 komada (Cena za kos / Cijena na komad 5,40 EUR) krč = 12 x 0,5 l (Cena za kos / Cijena na komad 4,30 EUR)	3838987 747291 3838987 572220 3838987 747307	124,00 108,00 51,60
Copelia-FS 180x80				
	Copelia-FS 180x80 -WHITE	kopalna kad iz KERROCK-a, samostoječa, UP&DOWN sistem s sifonom / kada za kupanje iz KERROCK-a, samostoječa, UP&DOWN sustav sa sifonom	3838987 779346	2.394,00
Dodatki za / Dodaci za Copelia-FS 180x80				
	WATERFALL	enoročna armatura s tuš ročico in izlivom / jednoručna armatura s tuš ručicom i izljevom	3838987 734543	562,00
	GEYSER	enoročna arm. s tuš ročico in polnilno /odlivno prelivno gar. za polnjenje kadi jednoručna arm. s tuš ručicom i priljev/odljev prelivnom garniturom za punjenje kada	3838987 506287	603,00
	RAINDROP	enoročna armatura s tuš ročico in izlivom / jednoručna armatura s tuš ručicom i izljevom	3838987 726500	590,00
	HEADREST COAST	vzglavnik naslon za glavu	3838987 593928	103,00
	Specialno čistilo KOLPA SAN Specialno sredstvo za čiščenje Specialno čistilo ECO SAN Specialno sredstvo za čiščenje KERIL - Specialno čistilo za KERROCK KERIL - Specijalno sredstvo	karton 20 kosov / karton 20 komada (Cena za kos / Cijena na komad 6,20 EUR) karton 20 kosov / karton 20 komada (Cena za kos / Cijena na komad 5,40 EUR) krč = 12 x 0,5 l (Cena za kos / Cijena na komad 4,30 EUR)	3838987 747291 3838987 572220 3838987 747307	124,00 108,00 51,60
10	www.kolpasan.si	www.kolpasan.hr		

Kopalne in masažne kadi

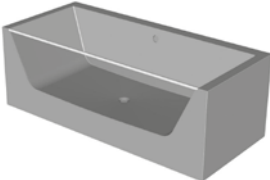
Kade za kupanje i masažne kade





Program:

kolpa·san
by kerrock

Model	Naziv in dimenzija izdelka Naziv i dimenzije produkta	Opis Opis	EAN koda EAN koda	Cena EUR Cijena EUR
Copelia LUX-FS 180x100				
	Copelia LUX-FS 180x100 -WHITE	samostoječa kopalna kad iz Kerrocka s policami ter odlagalno polico za na kad, odlivna garnitura z UP&DOWN sistemom in avtomatskim prelivom samostoječa kada od Kerrocka sa policama i policom za odlaganje za na kadu, odljevna garnitura sa UP&DOWN sustavom i automatskim preljevom	3838987 936541	3.681,00
Dodatki za / Dodaci za Copelia LUX-FS 180x100				
	HEADREST COAST	vzglavnik / naslon za glavu	3838987 593928	103,00
	Specialno čištilo KOLPA SAN Specialno sredstvo za čišćenje Specialno čištilo ECO SAN Specialno sredstvo za čišćenje KERIL - Specialno čištilo za KERROCK KERIL - Specijalno sredstvo	karton 20 kosov / karton 20 komada (Cena za kos / Cijena na komad 6,20 EUR) karton 20 kosov / karton 20 komada (Cena za kos / Cijena na komad 5,40 EUR) krt = 12 x 0,5 l (Cena za kos / Cijena na komad 4,30 EUR)	3838987 747291 3838987 572220 3838987 747307	124,00 108,00 51,60
Copelia LIGHT-FS 180x80				
	Copelia LIGHT-FS 180x80 -WHITE	samostoječa kopalna kad iz Kerrocka s transparentno akrilno steno, odlivno-prelivna garnitura z UP&DOWN sistemom. / samostoječa kada od Kerrocka sa prozirim zidom od akrila, odljevno-preljevna garnitura sa UP&DOWN sustavom.	3838987 590156	3.249,00
	Copelia LIGHT-FS 180x80+CTL -WHITE	samostoječa kopalna kad iz Kerrocka s transparentno akrilno steno, vgrajena kromoterapija, 2 RGB lučki, odlivno-prelivna garnitura z UP&DOWN sistemom / samostoječa kada od Kerrocka sa prozirim zidom od akrila, ugrađena cromotetapija, 2 RGB svijetla, odljevno-preljevna garnitura sa UP&DOWN sustavom	3838987 510475	3.504,00
	Copelia LIGHT-FS 180x80/MO Z+CTL -WHITE	samostoječa kopalna kad iz Kerrocka s transparentno akrilno steno, vgrajena cromoterapija, 2 RGB lučki, zračni masažni sistem, odlivno-prelivna garnitura z UP&DOWN sistemom / samostoječa kada od Kerrocka sa prozirim zidom od akrila, ugrađena cromotetapija, 2 RGB svijetla, zračni masažni sustav, odljevno-preljevna garnitura sa UP&DOWN sustavom.	3838987 596196	4.402,00
Dodatki za / Dodaci za Copelia LIGHT-FS 180x80				
	WATERFALL	enoročna armatura s tuš ročico in izlivom / jednoročna armatura s tuš ručicom i izljevom	3838987 734543	562,00
	GEYSER	enoročna arm. s tuš ročico in polnilno /odlivno prelivno gar. za polnjenje kadi jednoročna arm. s tuš ručicom i priljev/odljev preljevnom garniturom za punjenje kada	3838987 506287	603,00
	RAINDROP	enoročna armatura s tuš ročico in izlivom / jednoročna armatura s tuš ručicom i izljevom	3838987 726500	590,00
	HEADREST SOFT	vzglavnik	3838987 593942	79,00
	HEADREST COAST	naslon za glavu	3838987 593928	103,00
	Specialno čištilo KOLPA SAN Specialno sredstvo za čišćenje Specialno čištilo ECO SAN Specialno sredstvo za čišćenje KERIL - Specialno čištilo za KERROCK KERIL - Specijalno sredstvo	karton 20 kosov / karton 20 komada (Cena za kos / Cijena na komad 6,20 EUR) karton 20 kosov / karton 20 komada (Cena za kos / Cijena na komad 5,40 EUR) krt = 12 x 0,5 l (Cena za kos / Cijena na komad 4,30 EUR)	3838987 747291 3838987 572220 3838987 747307	124,00 108,00 51,60
	www.kolpa.hr	www.kolpa.si		11



Kopalne in masažne kadi Kade za kupanje i masažne kade		Program: kolpa·san®		
Model	Naziv in dimenzija izdelka Naziv i dimenzije produkta	Opis Opis	EAN koda EAN koda	Cena EUR Cijena EUR
Gloria-FS 180x80				
	Gloria-FS 180x80 -WHITE Gloria-FS 180x80 -BLACK&WHITE	samostoječa kopalna kad iz Kerrocka, odlivno-prelivna garnitura z UP&DOWN sistemom, barva zunanjega dela: WHITE, BLACK samostoječa kada od Kerrocka, odljevno-preljevna garnitura sa UP&DOWN sustavom boja vanjskog dijela: WHITE, BLACK	3838987 622642 3838987 592556	2.557,00 2.987,00
Dodatki za / Dodaci za Gloria-FS 180x80				
	HEADREST COAST	vzglavnik naslon za glavu	3838987 593928	103,00
	Specialno čistilo KOLPA SAN Specialno sredstvo za čišćenje Specialno čistilo ECO SAN Specialno sredstvo za čišćenje KERIL - Specialno čistilo za KERROCK KERIL - Specijalno sredstvo	karton 20 kosov / karton 20 komada (Cena za kos / Cijena na komad 6,20 EUR) karton 20 kosov / karton 20 komada (Cena za kos / Cijena na komad 5,40 EUR) krt = 12 x 0,5 l (Cena za kos / Cijena na komad 4,30 EUR)	3838987 747291 3838987 572220 3838987 747307	124,00 108,00 51,60

Blanche-FS 180x85				
	Blanche-FS 180x85 WHITE	samostoječa kopalna kad iz Kerrocka, UP&DOWN sistem s sifonom - BELA samostoječa kada od Kerrocka, UP&DOWN sustav sa sifonom - BIJELA	3838987 561090	2.115,00
	Blanche-FS 180x85 WHITE/ANTRACIT	samostoječa kopalna kad iz Kerrocka, UP&DOWN sistem s sifonom, barva zunanjega dela - ANTRACIT samostoječa kada od Kerrocka, UP&DOWN sustav sa sifonom - ANTRACIT	3838987 561316	2.286,00
Dodatki za / Dodaci za Blanche-FS 180x85				
	HEADREST COAST	vzglavnik naslon za glavu	3838987 593928	103,00
	Specialno čistilo KOLPA SAN Specialno sredstvo za čišćenje Specialno čistilo ECO SAN Specialno sredstvo za čišćenje KERIL - Specialno čistilo za KERROCK KERIL - Specijalno sredstvo	karton 20 kosov / karton 20 komada (Cena za kos / Cijena na komad 6,20 EUR) karton 20 kosov / karton 20 komada (Cena za kos / Cijena na komad 5,40 EUR) krt = 12 x 0,5 l (Cena za kos / Cijena na komad 4,30 EUR)	3838987 747291 3838987 572220 3838987 747307	124,00 108,00 51,60

Kopalne in masažne kadi

Kade za kupanje i masažne kade







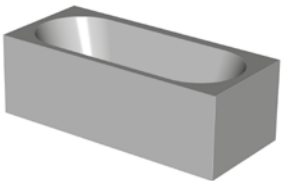

Program:kolpa·san[®]

Model	Naziv in dimenzija izdelka Naziv i dimenzije produkta	Opis Opis	EAN koda EAN koda	Cena EUR Cijena EUR
Ramona bathtub-FS 180x80				
	Ramona bathtub-FS 180x80	kopalna kad iz Kerrock-a, samostoječa, UP&DOWN sistem s sifonom / kada za kupanje iz Kerrock-a, samostoječa, UP&DOWN sustav sa sifonom	3838987 561255	2.953,00
Dodatki za / Dodaci za Ramona bathtub-FS 180x80				
	HEADREST COAST	vzglavnik naslon za glavu	3838987 593928	103,00
	Specialno čištilo KOLPA SAN Specialno sredstvo za čišćenje Specialno čištilo ECO SAN Specialno sredstvo za čišćenje KERIL - Specialno čištilo za KERROCK KERIL - Specijalno sredstvo	karton 20 kosov / karton 20 komada (Cena za kos / Cijena na komad 6,20 EUR) karton 20 kosov / karton 20 komada (Cena za kos / Cijena na komad 5,40 EUR) krt = 12 x 0,5 l (Cena za kos / Cijena na komad 4,30 EUR)	3838987 747291 3838987 572220 3838987 747307	124,00 108,00 51,60

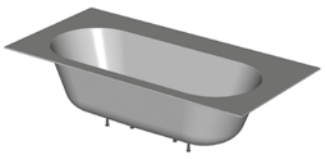
Atys DUO-FS 174x70

	Atys DUO-FS 174x70 -WHITE	samostoječa kopalna kad iz Kerrocka, odlivna garnitura z UP&DOWN sistemom, barva plošče: BLACK samostoječa kada od Kerrocka, odljevna garnitura sa UP&DOWN sustavom, boja ploče: BLACK	3838987 622765	1.854,00
Dodatki za / Dodaci za Atys DUO-FS 174x70				
	HEADREST COAST	vzglavnik naslon za glavu	3838987 593928	103,00
	Specialno čištilo KOLPA SAN Specialno sredstvo za čišćenje Specialno čištilo ECO SAN Specialno sredstvo za čišćenje KERIL - Specialno čištilo za KERROCK KERIL - Specijalno sredstvo	karton 20 kosov / karton 20 komada (Cena za kos / Cijena na komad 6,20 EUR) karton 20 kosov / karton 20 komada (Cena za kos / Cijena na komad 5,40 EUR) krt = 12 x 0,5 l (Cena za kos / Cijena na komad 4,30 EUR)	3838987 747291 3838987 572220 3838987 747307	124,00 108,00 51,60



Kopalne in masažne kadi Kade za kupanje i masažne kade		Program: kolpa·san®		
Model	Naziv in dimenzija izdelka Naziv i dimenzije produkta	Opis Opis	EAN koda EAN koda	Cena EUR Cijena EUR
Atys-FS 180x85				
	Atys-FS 180x85 -WHITE	samostoječa kopalna kad iz Kerrocka, odlivno-prelivna garnitura z UP&DOWN sistemom samostoječa kada od Kerrocka, odljevno-preljevna garnitura sa UP&DOWN sustavom	3838987 622833	2.523,00
Atys 180x85/0				
	Atys 180x85/0 -WHITE	kopalna kad z oblogo iz Kerrocka, odlivno-prelivna garnitura z UP&DOWN sistemom / kada s oblogom od Kerrocka, odljevno-preljevna garnitura sa UP&DOWN sustavom	3838987 922841	2.283,00
Atys 200x100				
	Atys 200x100 -WHITE	kopalna kad iz Kerrocka, odlivno-prelivna garnitura z UP&DOWN sistemom, vgradnja na ploščice oz. v nivo ploščic, možnost prerezovanja roba kadi / kada od Kerrocka, odljevno-preljevna garnitura sa UP&DOWN sustavom, ugradnja na ploščice odn. na razinu ploščica, mogućnost obrezivanja ruba kade	3838987 621430	1.813,00
Dodatki za / Dodaci za Atys				
	WATERFALL		enoročna armatura s tuš ročico in izlivom / jednoručna armatura s tuš ručicom i izjevom	3838987 734543 562,00
	RAINDROP		enoročna armatura s tuš ročico in izlivom / jednoručna armatura s tuš ručicom i izjevom	3838987 726500 590,00
	HEADREST COAST		vzglavnik naslon za glavu	3838987 593928 103,00
	Specialno čistilo KOLPA SAN Specialno sredstvo za čiščenje Specialno čistilo ECO SAN Specialno sredstvo za čiščenje KERIL - Specialno čistilo za KERROCK KERIL - Specijalno sredstvo		karton 20 kosov / karton 20 komada (Cena za kos / Cijena na komad 6,20 EUR) karton 20 kosov / karton 20 komada (Cena za kos / Cijena na komad 5,40 EUR) krt = 12 x 0,5 l (Cena za kos / Cijena na komad 4,30 EUR)	3838987 747291 124,00 3838987 572220 108,00 3838987 747307 51,60

Kopalne in masažne kadi

Kade za kupanje i masažne kade

Program:













kolpa·san
BY KOLPA

Model	Naziv in dimenzija izdelka Naziv i dimenzije produkta	Opis Opis	EAN koda EAN koda	Cena EUR Cijena EUR
Milo bathtub-FS 174x75 (188x78)				
	Milo bathtub-FS 174x75 -WHITE	samostoječa kopalna kad z belo ploščo, UP&DOWN sistem s sifonom, barva zunanjega dela; WHITE, BLACK, SAND, V.RED, L.GREEN, P.BLUE samostoječa kada za kupanje s bijelom pločom, UP&DOWN sustav sa sifonom, boja vanjskog dijela; WHITE, BLACK, SAND, V.RED, L.GREEN, P.BLUE	3838987 591528	1.849,00
	Milo bathtub-FS 174x75 -BLACK&WHITE		3838987 592440	2.457,00
	Milo bathtub-FS 174x75 -SAND&WHITE		3838987 592457	2.457,00
	Milo bathtub-FS 174x75 -V.RED&WHITE		3838987 592464	2.457,00
	Milo bathtub-FS 174x75 -L.GREEN&WHITE		3838987 592471	2.457,00
	Milo bathtub-FS 174x75 -P.BLUE&WHITE		3838987 592488	2.457,00
Dodatki za / Dodaci za Milo bathtub				
	HEADREST COAST	vzglavnik naslon za glavu	3838987 593928	103,00
	Specialno čištilo KOLPA SAN Specialno sredstvo za čišćenje	karton 20 kosov / karton 20 komada (Cena za kos / Cijena na komad 6,20 EUR)	3838987 747291	124,00
	Specialno čištilo ECO SAN Specialno sredstvo za čišćenje	karton 20 kosov / karton 20 komada (Cena za kos / Cijena na komad 5,40 EUR)	3838987 572220	108,00
	KERIL - Specialno čištilo za KERROCK KERIL - Specijalno sredstvo	krt = 12 x 0,5 l (Cena za kos / Cijena na komad 4,30 EUR)	3838987 747307	51,60

Boul bathtub-FS 165x85

	Boul bathtub-FS 165x85 -WHITE	Samostojeća kopalna kad v beli barvi s prelivno garnituro, UP&DOWN sistem s sifonom, barva zunanjega dela; WHITE, BLACK, SAND Samostojeća kada u bijeloj boji, sa preljevnom garnituro, UP&DOWN sustav sa sifonom, boja vanjskog dijela; WHITE, BLACK, SAND	3838987 591566	5.138,00
	Boul bathtub-FS 165x85 -BLACK&WHITE		3838987 592303	5.817,00
	Boul bathtub-FS 165x85 -SAND&WHITE		3838987 592310	5.817,00
Dodatki za / Dodaci za Boul bathtub				
	Specialno čištilo KOLPA SAN Specialno sredstvo za čišćenje	karton 20 kosov / karton 20 komada (Cena za kos / Cijena na komad 6,20 EUR)	3838987 747291	124,00
	Specialno čištilo ECO SAN Specialno sredstvo za čišćenje	karton 20 kosov / karton 20 komada (Cena za kos / Cijena na komad 5,40 EUR)	3838987 572220	108,00
	KERIL - Specialno čištilo za KERROCK KERIL - Specijalno sredstvo	krt = 12 x 0,5 l (Cena za kos / Cijena na komad 4,30 EUR)	3838987 747307	51,60









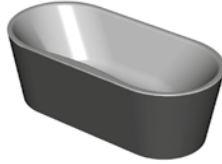
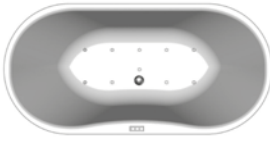
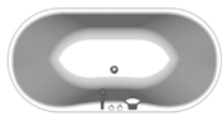

Kopalne in masažne kadi Kade za kupanje i masažne kade		Program: kolpa·san®		
Model	Naziv in dimenzija izdelka Naziv i dimenzije produkta	Opis Opis	EAN koda EAN koda	Cena EUR Cijena EUR
Adam & Eva-FS 190x120				
	Adam & Eva-FS 190x120 WHITE	samostoječa kopalna kad s prelivno garnituro - kad in obloga iz enega dela samostoječa kada s prelivnom garniturom - kada i obloga su iz jednog dijela	3838987 561132	2.412,00
	Zračni masažni sistem Zračni masažni sistem ELEKTRONSKI Adam & Eva-FS 190x120/MO	samostoječa BELA samostoječa BIJELA	3838987 576754	3.239,00
Dodatki za / Dodaci za Adam & Eva-FS 190x120				
	GEYSER 	enoročna arm. s tuš ročico in polnilno /odlivno prelivno gar. za polnjenje kadi jednoručna arm. s tuš ručicom i priljev/odljev prelivnom garniturom za punjenje kada	3838987 506287	603,00
	RAINDROP 	enoročna armatura s tuš ročico in izlivom / jednoručna armatura s tuš ručicom i izljevom	3838987 726500	590,00
	HEADREST COAST	vzglavnik naslon za glavu	3838987 593928	103,00
	Chromotherapia (CTL) Chromotherapia (CTL)	2 LED lučki s samostojno tipkovnico 2 LED svjetla sa samostalnom tipkovnicom		382,00
	ANTI-SLIP PREMAZ	protizdrnsni premaz za kopalne kadi protiv klizni premaz za kupaonske kade (min. kol. 10 kos)		67,00
	Specialno čištilo KOLPA SAN Specialno sredstvo za čišćenje	karton 20 kosov / karton 20 komada (Cena za kos / Cijena na komad 6,20 EUR)	3838987 747291	124,00
	Specialno čištilo ECO SAN Specialno sredstvo za čišćenje	karton 20 kosov / karton 20 komada (Cena za kos / Cijena na komad 5,40 EUR)	3838987 572220	108,00
	Čistilo za masažne sisteme Sredstvo za čišćenje masažnih sistema	karton 10 kosov / karton 10 komada (Cena za kos / Cijena na komad 7,80 EUR)	3838987 747277	78,00

Kopalne in masažne kadi

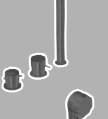



Kade za kupanje i masažne kade

Program:

kolpa·san
BY KOLPA

Model	Naziv in dimenzija izdelka Naziv i dimenzije produkta	Opis Opis	EAN koda EAN koda	Cena EUR Cijena EUR
Comodo-FS 185x90				
	Comodo-FS 185x90 WHITE	samostoječa kopalna kad s prelivno garnituro - kad in obloga iz enega dela samostoječa kada s prelivnom garniturom - kada i obloga su iz jednog dijela	3838987 593836	1.342,00
	Comodo-FS 185x90 BLACK & WHITE	samostoječa kopalna kad s prelivno garnituro, obloga in kad iz enega dela - ČRNO, SIVO / BELA samostoječa kada s prelivnom garniturom obloga i kada su iz jednog dijela - CRNO, SIVO / BIJELA	3838987 593799	1.566,00
	Comodo-FS 185x90 GREY & WHITE		3838987 922919	1.566,00
Zračni masažni sistem Zračni masažni sistem ELEKTRONSKI				
	Comodo-FS 185x90/MO WHITE	samostoječa BELA / samostoječa BIJELA	3838987 570363	2.301,00
	Comodo-FS 185x90/MO BLACK & WHITE	samostoječa ČRNO, SIVO / BELA	3838987 591825	2.497,00
	Comodo-FS 185x90/MO GREY & WHITE	samostoječa CRNO, SIVO / BIJELA	3838987 518068	2.497,00
Dodatki za / Dodaci za Comodo-FS 185x90				
	WATERFALL	 enoročna armatura s tuš ročico in izlivom / jednoročna armatura s tuš ručicom i izljevom	3838987 734543	562,00
	GEYSER	 enoročna arm. s tuš ročico in polnilno /odlivno prelivno gar. za polnjenje kadi jednoročna arm. s tuš ručicom i priljev/odljev prelivnom garniturom za punjenje kadi	3838987 506287	603,00
	RAINDROP	 enoročna armatura s tuš ročico in izlivom / jednoročna armatura s tuš ručicom i izljevom	3838987 726500	590,00
	HEADREST COAST	vzglavnik naslon za glavu	3838987 593928	103,00
	Chromotherapia (CTL) Chromotherapia (CTL)	2 LED lučki s samostojno tipkovnicom 2 LED svjetla sa samostalnom tipkovnicom		382,00
	ANTI-SLIP PREMAZ	protizdrsni premaz za kopalne kadi protiv klizni premaz za kupaonske kade (min. kol. 10 kos)		67,00
	Specialno čištilo KOLPA SAN Specialno sredstvo za čišćenje	karton 20 kosov / karton 20 komada (Cena za kos / Cijena na komad 6,20 EUR)	3838987 747291	124,00
	Specialno čištilo ECO SAN Specialno sredstvo za čišćenje	karton 20 kosov / karton 20 komada (Cena za kos / Cijena na komad 5,40 EUR)	3838987 572220	108,00
	Čistilo za masažne sisteme Sredstvo za čišćenje masažnih sistema	karton 10 kosov / karton 10 komada (Cena za kos / Cijena na komad 7,80 EUR)	3838987 747277	78,00









Kopalne in masažne kadi Kade za kupanje i masažne kade		Program: kolpa·san®		
Model	Naziv in dimenzija izdelka Naziv i dimenzije produkta	Opis Opis	EAN koda EAN koda	Cena EUR Cijena EUR
Soft-FS 180x80				
	Soft-FS 180x80 WHITE	samostoječa kopalna kad, kad in obloga iz enega dela, odlivna garnitura z UP&DOWN sistemom, barva: BELA Samostoječa kada, kada i obloga su iz jednog dijela, odljevna garnitura sa UP&DOWN sustavom, boja: BIJELA	3838987 922803	1.436,00
Dodatki za / Dodaci za Soft-FS 180x80				
	HEADREST COAST	vzglavnik naslon za glavu	3838987 593928	103,00
	ANTI-SLIP PREMAZ	protizdrсни premaz za kopalne kadi protiv klizni premaz za kupaonske kade (min. kol. 10 kos)		67,00
	Specialno čistilo KOLPA SAN Specialno sredstvo za čišćenje Specialno čistilo ECO SAN Specialno sredstvo za čišćenje	karton 20 kosov / karton 20 komada (Cena za kos / Cijena na komad 6,20 EUR) karton 20 kosov / karton 20 komada (Cena za kos / Cijena na komad 5,40 EUR)	3838987 747291 3838987 572220	124,00 108,00













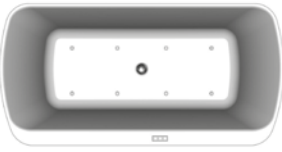
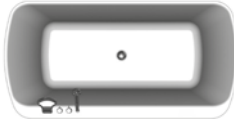

Kopalne in masažne kadi

Kade za kupanje i masažne kade

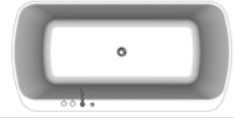
Program:**kolpa·san**
BY KOLPA

Model	Naziv in dimenzija izdelka Naziv i dimenzije produkta	Opis Opis	EAN koda EAN koda	Cena EUR Cijena EUR
Soft 180x80				
	Soft 180x80 WHITE	kopalna kad za vgradnjo kada za ugradnju	3838987 922827	355,00
Dodatki za / Dodaci za Soft 180x80				
	UP&DOWN, WHITE	prelivna garnitura s sifonom, bela preljevna garnitura sa sifonom, bijela	3838987 922759	62,00
	HEADREST COAST	vzglavnik naslon za glavu	3838987 593928	103,00
	PKK 501	podnožje kopalne kadi za vgradnjo podnožje kupaonske kade za ugradnju	3838987 764878	28,00
	ANTI-SLIP PREMAZ	protizdrsni premaz za kopalne kadi protiv klizni premaz za kupaonske kade (min. kol. 10 kos)		67,00
	Specialno čištilo KOLPA SAN Specialno sredstvo za čišćenje	karton 20 kosov / karton 20 komada (Cena za kos / Cijena na komad 6,20 EUR)	3838987 747291	124,00
	Specialno čištilo ECO SAN Specialno sredstvo za čišćenje	karton 20 kosov / karton 20 komada (Cena za kos / Cijena na komad 5,40 EUR)	3838987 572220	108,00

Kopalne in masažne kadi
Kade za kupanje i masažne kade





Kopalne in masažne kadi Kade za kupanje i masažne kade		Program: kolpa·san®		
Model	Naziv in dimenzija izdelka Naziv i dimenzije produkta	Opis Opis	EAN koda EAN koda	Cena EUR Cijena EUR
Marilyn-FS 180x90				
	Marilyn-FS 180x90 WHITE	samostoječa kopalna kad s prelivno garnituro, kad in obloga iz enega dela - BELA samostoječa kada s prelivnom garniturom kada i obloga su iz jednog dijela - BIJELA	3838987 593973	1.405,00
	Marilyn-FS 180x90 BLACK & WHITE	samostoječa kopalna kad s prelivno garnituro, obloga in kad iz enega dela - ČRNO, SIVO / BELA samostoječa kada s prelivnom garniturom obloga i kada su iz jednog dijela - CRNO, SIVO / BIJELA	3838987 593843	1.627,00
	Marilyn-FS 180x90 GREY & WHITE		3838987 927310	1.627,00
Zračni masažni sistem Zračni masažni sistem ELEKTRONSKI				
	Marilyn-FS 180x90/MO WHITE	samostoječa BELA / samostoječa BIJELA	3838987 596455	2.356,00
	Marilyn-FS 180x90/MO BLACK & WHITE	samostoječa ČRNO, SIVO / BELA	3838987 592211	2.551,00
	Marilyn-FS 180x90/MO GREY & WHITE	samostoječa CRNO, SIVO / BIJELA	3838987 518051	2.551,00
Dodatki za / Dodaci za Marilyn-FS 180x90				
	WATERFALL	 enoročna armatura s tuš ročico in izlivom / jednoročna armatura s tuš ručicom i izljevom	3838987 734543	562,00
	GEYSER	 enoročna arm. s tuš ročico in polnilno /odlivno prelivno gar. za polnjenje kadi jednoročna arm. s tuš ručicom i priljev/odljev prelivnom garniturom za punjenje kada	3838987 506287	603,00
	RAINDROP	 enoročna armatura s tuš ročico in izlivom / jednoročna armatura s tuš ručicom i izljevom	3838987 726500	590,00
	HEADREST COAST	vzglavnik naslon za glavu	3838987 593928	103,00
	Chromotherapia (CTL) Chromotherapia (CTL)	2 LED lučki s samostojno tipkovnicom 2 LED svjetla sa samostalnom tipkovnicom		382,00
	ANTI-SLIP PREMAZ	protizdrnsni premaz za kopalne kadi protiv klizni premaz za kupaonske kade (min. kol. 10 kos)		67,00
	Specialno čištilo KOLPA SAN Specialno sredstvo za čišćenje Specialno čištilo ECO SAN Specialno sredstvo za čišćenje Čistilo za masažne sisteme Sredstvo za čišćenje masažnih sistema	karton 20 kosov / karton 20 komada (Cena za kos / Cijena na komad 6,20 EUR) karton 20 kosov / karton 20 komada (Cena za kos / Cijena na komad 5,40 EUR) karton 10 kosov / karton 10 komada (Cena za kos / Cijena na komad 7,80 EUR)	3838987 747291 3838987 572220 3838987 747277	124,00 108,00 78,00

Kopalne in masažne kadi





Kade za kupanje i masažne kade

Program:

kolpa·san®

Model	Naziv in dimenzija izdelka Naziv i dimenzije produkta	Opis Opis	EAN koda EAN koda	Cena EUR Cijena EUR
Pandora bathtub-FS 173, 163				
	Pandora bathtub-FS 173x78 WHITE	samostoječa kopalna kad, UP&DOWN sistem s sifonom, kad in obloga iz enega dela samostoječa kada, UP&DOWN sustav sa sifonom, kada i obloga su iz jednog dijela	3838987 593157	1.527,00
	Pandora bathtub-FS 163x68 WHITE	samostoječa kopalna kad, UP&DOWN sistem s sifonom, kad in obloga iz enega dela samostoječa kada, UP&DOWN sustav sa sifonom, kada i obloga su iz jednog dijela	3838987 593423	1.497,00
Dodatki za / Dodaci za Pandora bathtub-FS 173, 163				
	HEADREST COAST	vzglavnik naslon za glavu	3838987 593928	103,00
	ANTI-SLIP PREMAZ	protizdrsni premaz za kopalne kadi protiv klizni premaz za kupaonske kade (min. kol. 10 kos)		67,00
	Specialno čištilo KOLPA SAN Specialno sredstvo za čišćenje	karton 20 kosov / karton 20 komada (Cena za kos / Cijena na komad 6,20 EUR)	3838987 747291	124,00
	Specialno čištilo ECO SAN Specialno sredstvo za čišćenje	karton 20 kosov / karton 20 komada (Cena za kos / Cijena na komad 5,40 EUR)	3838987 572220	108,00



Kopalne in masažne kadi Kade za kupanje i masažne kade		Program: kolpa·san®		
Model	Naziv in dimenzija izdelka Naziv i dimenzije produkta	Opis Opis	EAN koda EAN koda	Cena EUR Cijena EUR
Dalia-FS 170x80				
	Dalia-FS 170x80 WHITE	samostoječa kopalna kad s prelivno garnituro, kad in obloga iz enega dela - BELA samostoječa kada s prelivnom garniturom kada i obloga su iz jednog dijela - BIJELA	3838987 561149	1.396,00
	Dalia-FS 170x80 BLACK & WHITE	samostoječa kopalna kad s prelivno garnituro, obloga in kad iz enega dela - ČRNO, SIVO / BELA samostoječa kada s prelivnom garniturom obloga i kada su iz jednog dijela - CRNO, SIVO / BIJELA	3838987 561767	1.452,00
	Dalia-FS 170x80 GREY & WHITE		3838987 927334	1.452,00
Dodatki za / Dodaci za Dalia-FS 170x80				
	HEADREST COAST	vzglavnik naslon za glavu	3838987 593928	103,00
	ANTI-SLIP PREMAZ	protizdrsni premaz za kopalne kadi protiv klizni premaz za kupaonske kade (min. kol. 10 kos)		67,00
	Specialno čistilo KOLPA SAN Specialno sredstvo za čišćenje Specialno čistilo ECO SAN Specialno sredstvo za čišćenje	karton 20 kosov / karton 20 komada (Cena za kos / Cijena na komad 6,20 EUR)	3838987 747291	124,00
		karton 20 kosov / karton 20 komada (Cena za kos / Cijena na komad 5,40 EUR)	3838987 572220	108,00













Lux-FS 170x85

Kopalne in masažne kadi
Kade za kupanje i masažne kade















Lux 170x85

Kopalne in masažne kadi Kade za kupanje i masažne kade		Program: kolpa·san®		
Model	Naziv in dimenzija izdelka Naziv i dimenzije produkta	Opis Opis	EAN koda EAN koda	Cena EUR Cijena EUR
Lux-FS 170x85				
	Lux-FS 170x85 WHITE	samostoječa kopalna kad, kad in obloga iz enega dela, odlivna garnitura z UP&DOWN sistemom, barva: BELA Samostoječa kada, kada i obloga su iz jednog dijela, odljevna garnitura sa UP&DOWN sustavom, boja: BIJELA	3838987 922810	1.372,00
Dodatki za / Dodaci za Lux-FS 170x85				
	WATERFALL	 enoročna armatura s tuš ročico in izlivom / jednoručna armatura s tuš ručicom i izljevom	3838987 734543	562,00
	GEYSER	 enoročna arm. s tuš ročico in polnilno /odlivno prelivno gar. za polnjenje kadi jednoručna arm. s tuš ručicom i priljev/odljev prelivnom garniturom za punjenje kadi	3838987 506287	603,00
	RAINDROP	 enoročna armatura s tuš ročico in izlivom / jednoručna armatura s tuš ručicom i izljevom	3838987 726500	590,00
	HEADREST COAST	vzglavnik naslon za glavu	3838987 593928	103,00
	ANTI-SLIP PREMAZ	protizdrsni premaz za kopalne kadi protiv klizni premaz za kupaonske kade (min. kol. 10 kos)		67,00
	Specialno čistilo KOLPA SAN Specialno sredstvo za čišćenje Specialno čistilo ECO SAN Specialno sredstvo za čišćenje	karton 20 kosov / karton 20 komada (Cena za kos / Cijena na komad 6,20 EUR) karton 20 kosov / karton 20 komada (Cena za kos / Cijena na komad 5,40 EUR)	3838987 747291 3838987 572220	124,00 108,00





Kopalne in masažne kadi

Kade za kupanje i masažne kade

Program:kolpa·san[®]

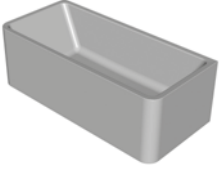
Model	Naziv in dimenzija izdelka Naziv i dimenzije produkta	Opis Opis	EAN koda EAN koda	Cena EUR Cijena EUR
Lux 170x85				
	Lux 170x85 WHITE	kopalna kad za vgradnjo kada za ugradnju	3838987 922834	340,00
Dodatki za / Dodaci za Lux 170x85				
	WATERFALL 	enoročna armatura s tuš ročico in izlivom / jednoručna armatura s tuš ručicom i izljevom	3838987 734543	562,00
	GEYSER 	enoročna arm. s tuš ročico in polnilno /odlivno prelivno gar. za polnjenje kadi jednoručna arm. s tuš ručicom i prijev/odljev prelivnom garniturom za punjenje kada	3838987 506287	603,00
	RAINDROP 	enoročna armatura s tuš ročico in izlivom / jednoručna armatura s tuš ručicom i izljevom	3838987 726500	590,00
	UP&DOWN, WHITE	prelivna garnitura s sifonom, bela prelivna garnitura sa sifonom, bijela	3838987 922759	62,00
	HEADREST COAST	vzglavnik naslon za glavu	3838987 593928	103,00
	PKK 501	podnožje kopalne kadi za vgradnjo podnožje kupaonske kade za ugradnju	3838987 764878	28,00
	ANTI-SLIP PREMAZ	protizdrsni premaz za kopalne kadi protiv klizni premaz za kupaonske kade (min. kol. 10 kos)		67,00
	Specialno čistilo KOLPA SAN Specialno sredstvo za čišćenje Specialno čistilo ECO SAN Specialno sredstvo za čišćenje	karton 20 kosov / karton 20 komada (Cena za kos / Cijena na komad 6,20 EUR) karton 20 kosov / karton 20 komada (Cena za kos / Cijena na komad 5,40 EUR)	3838987 747291 3838987 572220	124,00 108,00













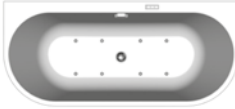
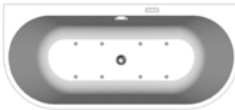



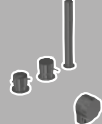

Kopalne in masažne kadi Kade za kupanje i masažne kade		Program: kolpa·san [®]		
Model	Naziv in dimenzija izdelka Naziv i dimenzije produkta	Opis Opis	EAN koda EAN koda	Cena EUR Cijena EUR
Elektra-SP 185, 175				
	Elektra-SP 185x85	kopalna kad s prelivno garnituro	3838987 513469	1.259,00
	Elektra-SP 175x75	- kad in obloga iz enega dela kada s preljevnom garnituro - kada i obloga su iz jednog dijela	3838987 513490	1.217,00
Dodatki za / Dodaci za Elektra-SP 185, 175				
	HEADREST SOFT	vzglavnik naslon za glavu	3838987 593942	79,00
	HEADREST COAST		3838987 593928	103,00
	Suhomontažna zaključna letev Završna letva u sistemu suhe montaže	karton 25 kosov / karton 25 komada (Cena za kos / Cijena na komad 30,60 EUR)	3838987 903116	765,00
	ANTI-SLIP PREMAZ	protizdrsni premaz za kopalne kadi protiv klizni premaz za kupaonske kade (min. kol. 10 kos)		67,00
	Specijalno čištilo KOLPA SAN Specijalno sredstvo za čišćenje	karton 20 kosov / karton 20 komada (Cena za kos / Cijena na komad 6,20 EUR)	3838987 747291	124,00
	Specijalno čištilo ECO SAN Specijalno sredstvo za čišćenje	karton 20 kosov / karton 20 komada (Cena za kos / Cijena na komad 5,40 EUR)	3838987 572220	108,00

Kopalne in masažne kadi

Kade za kupanje i masažne kade

Program:

kolpa·san
BY KOLPA

Model	Naziv in dimenzija izdelka Naziv i dimenzije produkta	Opis Opis	EAN koda EAN koda	Cena EUR Cijena EUR
Dream-SP 180, 170				
	Dream-SP 180x80 Dream-SP 170x75	kopalna kad s prelivno garnituro - kad in obloga iz enega dela kada s preljevnom garniturom - kada i obloga su iz jednog dijela	3838987 570394 3838987 570554	1.086,00 1.037,00
	Zračni masažni sistem Zračni masažni sistem ELEKTRONSKI Dream-SP 180x80/MO	kopalna kad s prelivno garnituro - kad in obloga iz enega dela kada s preljevnom garniturom - kada i obloga su iz jednog dijela	3838987 576921	2.077,00
	Zračni masažni sistem Zračni masažni sistem ELEKTRONSKI Dream-SP 170x75/MO	kopalna kad s prelivno garnituro - kad in obloga iz enega dela kada s preljevnom garniturom - kada i obloga su iz jednog dijela	3838987 577195	2.001,00
Dodatki za / Dodaci za				
Dream-SP 180x80, 170x75				
 180x80	 170x75	WATERFALL 	enoročna armatura s tuš ročico in izlivom / jednoručna armatura s tuš ručicom i izljevom	3838987 734543 562,00
 180x80	 170x75	GEYSER 	enoročna arm. s tuš ročico in polnilno /odlivno prelivno gar. za polnjenje kadi jednoručna arm. s tuš ručicom i priljev/odljev preljevnom garniturom za punjenje kada	3838987 506287 603,00
 180x80	 170x75	RAINDROP 	enoročna armatura s tuš ročico in izlivom / jednoručna armatura s tuš ručicom i izljevom	3838987 726500 590,00
		HEADREST SOFT	vzglavnik naslon za glavu	3838987 593942 79,00
		HEADREST COAST		3838987 593928 103,00
		Suhomontažna zaključna letva Završna letva u sistemu suhe montaže	karton 25 kosov / karton 25 komada (Cena za kos / Cijena na komad 30,60 EUR)	3838987 903116 765,00
		Chromoterapia (CTL) Chromoterapia (CTL)	2 LED lučki s samostojno tipkovnicu 2 LED svjetla sa samostalnom tipkovnicom	382,00
		ANTI-SLIP PREMAZ	protizdrsni premaz za kopalne kadi protiv klizni premaz za kupaonske kade (min. kol. 10 kos)	67,00
		Specijalno čištilo KOLPA SAN Specijalno sredstvo za čišćenje Specijalno čištilo ECO SAN Specijalno sredstvo za čišćenje Čištilo za masažne sisteme Sredstvo za čišćenje masažnih sistema	karton 20 kosov / karton 20 komada (Cena za kos / Cijena na komad 6,20 EUR) karton 20 kosov / karton 20 komada (Cena za kos / Cijena na komad 5,40 EUR) karton 10 kosov / karton 10 komada (Cena za kos / Cijena na komad 7,80 EUR)	124,00 108,00 78,00



Kopalne in masažne kadi Kade za kupanje i masažne kade		Program: kolpa·san®		
Model	Naziv in dimenzija izdelka Naziv i dimenzije produkta	Opis Opis	EAN koda EAN koda	Cena EUR Cijena EUR
Opera 180				
	Vital masažni sistem + mikrošobe Vital masažni sistem ELEKTRONSKI Opera 180	okrogla masažna kopalna kad z ročajem za vgradnjo / ugradna okrogla masažna kupaonska kada sa ručicom okrogla masažna kopalna kad z ročajem in z oblogo / okrogla masažna kupaonska kada sa ručicom i oblogom	3838987 571902 3838987 571919	4.075,00 4.518,00
Dodatki za / Dodaci za Opera 180				
	WATERFALL 	enoročna armatura s tuš ročico in izlivom / jednoručna armatura s tuš ručicom i izljevom	3838987 734543	562,00
	GEYSER 	enoročna arm. s tuš ročico in polnilno /odlivno prelivno gar. za polnjenje kadi / jednoručna arm. s tuš ručicom i priljev/odljev prelivnom garniturom za punjenje kada	3838987 506287	603,00
	RAINDROP 	enoročna armatura s tuš ročico in izlivom / jednoručna armatura s tuš ručicom i izljevom	3838987 726500	590,00
	HEADREST COAST	vzglavnik naslon za glavu	3838987 593928	103,00
	Servisno prezračevalni pokrov z rešetko Servisno ventilacijski pokrov s rešetkom	za masažne kadi za vgradnjo (45x45 cm) / za masažne kade za ugradnju (45x45 cm)	3838987 534808	90,00
	Specialno čistilo KOLPA SAN Specialno sredstvo za čiščenje	karton 20 kosov / karton 20 komada (Cena za kos / Cijena na komad 6,20 EUR)	3838987 747291	124,00
	Specialno čistilo ECO SAN Specialno sredstvo za čiščenje	karton 20 kosov / karton 20 komada (Cena za kos / Cijena na komad 5,40 EUR)	3838987 572220	108,00
	Čistilo za masažne sisteme Sredstvo za čiščenje masažnih sistema	karton 10 kosov / karton 10 komada (Cena za kos / Cijena na komad 7,80 EUR)	3838987 747277	78,00

Kopalne in masažne kadi

Kade za kupanje i masažne kade

Program:

kolpa·san
by KOLPA

Model	Naziv in dimenzija izdelka Naziv i dimenzije produkta	Opis Opis	EAN koda EAN koda	Cena EUR Cijena EUR
Gaia 160x160				
	Vital masažni sistem + mikrošobe Vital masažni sistem ELEKTRONSKI Gaia 160x160	kotna masažna kopalna kad za vgradnjo, z enoročno armaturo in tuš ročico WATERFALL ugradna kutna masažna kupaonska kada, jednoručna armatura i tuš ručka WATERFALL	3838987 513872	4.533,00
	Vital masažni sistem + mikrošobe Vital masažni sistem ELEKTRONSKI Gaia 160/0	kotna masažna kopalna kad z oblogo, enoročno armaturo in tuš ročico WATERFALL kutna masažna kupaonska kada s oblogom, jednoručna armatura i tuš ručka WATERFALL	3838987 513919	4.719,00
	Vital masažni sistem + mikrošobe Vital masažni sistem ELEKTRONSKI Gaia 160x160 - polnjenje kadi preko preliva - punjenje kade preko preljeva	kotna masažna kopalna kad za vgradnjo, z enoročno armaturo in tuš ročico GEYSER ugradna kutna masažna kupaonska kada, jednoručna armatura i tuš ručka GEYSER	3838987 513889	4.505,00
	Vital masažni sistem + mikrošobe Vital masažni sistem ELEKTRONSKI Gaia 160/0 - polnjenje kadi preko preliva - punjenje kade preko preljeva	kotna masažna kopalna kad z oblogo, enoročno armaturo in tuš ročico GEYSER kutna masažna kupaonska kada s oblogom, jednoručna armatura i tuš ručka GEYSER	3838987 513926	4.696,00
Dodatki za / Dodaci za Gaia 160x160				
	Stopnica Gaia stepenica Gaia	- bela / bijela	3838987 903314	187,00
	Zidni montažni set Zidni montažni set	za kopalne in tuš kadi za vgradnjo za kupaonske i tuš kade za ugradnju	3838987 704362	11,00
	Suhomontažna zaključna letva Završna letva u sistemu suhe montaže	karton 25 kosov / karton 25 komada (Cena za kos / Cijena na komad 30,60 EUR)	3838987 903116	765,00
	Servisno prezračevalni pokrov z rešetko Servisno ventilacijski pokrov s rešetkom	za masažne kadi za vgradnjo (45x45 cm) za masažne kade za ugradnju (45x45 cm)	3838987 534808	90,00
	Specijalno čištilo KOLPA SAN Specijalno sredstvo za čišćenje	karton 20 kosov / karton 20 komada (Cena za kos / Cijena na komad 6,20 EUR)	3838987 747291	124,00
	Specijalno čištilo ECO SAN Specijalno sredstvo za čišćenje	karton 20 kosov / karton 20 komada (Cena za kos / Cijena na komad 5,40 EUR)	3838987 572220	108,00
	Čištilo za masažne sisteme Sredstvo za čišćenje masažnih sistema	karton 10 kosov / karton 10 komada (Cena za kos / Cijena na komad 7,80 EUR)	3838987 747277	78,00



Kopalne in masažne kadi

Kade za kupanje i masažne kade

Program:kolpa·san[®]

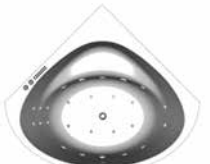

Model	Naziv in dimenzija izdelka Naziv i dimenzije produkta	Opis Opis	EAN koda EAN koda	Cena EUR Cijena EUR
Dolores 150x150				
	Dolores 150x150	kopalna kad za vgradnjo kada za ugradnju	3838987 565208	467,00
	Obloga Dolores 150	obloga za kopalno kad obloga za kupaonsku kadu	3838987 565239	259,00
	CKM 120-150	podnožje kopalne kadi za oblogo podnožje kupaonske kade za oblogu	3838987 573043	159,00
	Vodni masažni sistem I. Vodeni masažni sistem I. PNEVMATSKI Dolores 150x150	z oblogo s oblogom z oblogo + mikrošobe s oblogom + mikromlaznice	3838987 927617 3838987 927624	1.817,00 2.356,00
	Kombinirani (vodni in zračni) masažni sistem / Kombinirani (vodeni i zračni) masažni sistem ELEKTRONSKI Dolores 150x150	z oblogo s oblogom z oblogo + mikrošobe s oblogom + mikromlaznice	3838987 927631 3838987 927648	2.975,00 3.514,00
	Vital masažni sistem Vital masažni sistem ELEKTRONSKI Dolores 150x150	z oblogo + mikrošobe s oblogom + mikromlaznice	3838987 927655	4.490,00
Vgradnja mikrošob v kad Ugradnja mikromlaznica u kadu Dolores 150x150				
	Prikaz vgradnje mikrošob Prikaz ugradnje mikromlaznica Dolores 150x150			

Kopalne in masažne kadi

Kade za kupanje i masažne kade

Program:

kolpa·san
BY KOLPA





Model	Naziv in dimenzija izdelka Naziv i dimenzije produkta	Opis Opis	EAN koda EAN koda	Cena EUR Cijena EUR
Dodatki za / Dodaci za Dolores 150x150				
	GEYSER 	enoročna arm. s tuš ročico in polnilno /odlivno prelivno gar. za polnjenje kadi jednoručna arm. s tuš ručicom i priljev/odljev prelivnom garnituroom za punjenje kada	3838987 506287	603,00
	RAINDROP 	enoročna armatura s tuš ročico in izlivom / jednoručna armatura s tuš ručicom i izljevom	3838987 726500	590,00
	UP&DOWN, WHITE	prelivna garnitura s sifonom, bela preljevna garnitura sa sifonom, bijela	3838987 922759	62,00
	PAL 650	prelivna garnitura s sifonom preljevna garnitura sa sifonom	3838987 746270	55,00
	HEADREST SOFT	vzglavnik naslon za glavu	3838987 593942	79,00
	HEADREST COAST	vzglavnik naslon za glavu	3838987 593928	103,00
	1001/B	podnožje kopalne kadi za vgradnjo podnožje kupaonske kade za ugradnju	3838987 876502	49,00
	Zidni montažni set Zidni montažni set	za kopalne in tuš kadi za vgradnjo za kupaonske i tuš kade za ugradnju	3838987 704362	11,00
	Suhomontažna zaključna letva Završna letva u sistemu suhe montaže	karton 25 kosov / karton 25 komada (Cena za kos / Cijena na komad 30,60 EUR)	3838987 903116	765,00
	Chromoterapia (CTL) Chromoterapia (CTL)	2 LED lučki s samostojno tipkovnicom 2 LED svjetla sa samostalnom tipkovnicom		382,00
	Dve dodatni mikro šobi Dvije dodatne mikro mlaznice	za masažo stopal (kpl) za masažu stopala (kpl)		61,00
	Servisno prezračevalni pokrov z rešetko Servisno ventilacijski pokrov s rešetkom	za masažne kadi za vgradnjo (45x45 cm) za masažne kade za ugradnju (45x45 cm)	3838987 534808	90,00
	ANTI-SLIP PREMAZ	protizdrsni premaz za kopalne kadi protiv klizni premaz za kupaonske kade (min. kol. 10 kos)		67,00
	Specialno čistilo KOLPA SAN Specialno sredstvo za čišćenje	karton 20 kosov / karton 20 komada (Cena za kos / Cijena na komad 6,20 EUR)	3838987 747291	124,00
	Specialno čistilo ECO SAN Specialno sredstvo za čišćenje	karton 20 kosov / karton 20 komada (Cena za kos / Cijena na komad 5,40 EUR)	3838987 572220	108,00
	Čistilo za masažne sisteme Sredstvo za čišćenje masažnih sistema	karton 10 kosov / karton 10 komada (Cena za kos / Cijena na komad 7,80 EUR)	3838987 747277	78,00



Kopalne in masažne kadi

Kade za kupanje i masažne kade

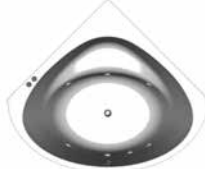
Program:kolpa·san[®]

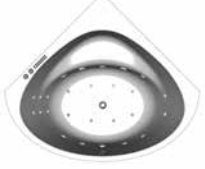
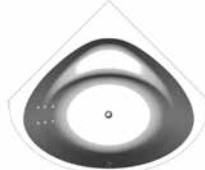
Model	Naziv in dimenzija izdelka Naziv i dimenzije produkta	Opis Opis	EAN koda EAN koda	Cena EUR Cijena EUR
Dolores 140x140				
	Dolores 140x140	kopalna kad za vgradnjo kada za ugradnju	3838987 565284	402,00
	Obloga Dolores 140	obloga za kopalno kad obloga za kupaonsku kadu	3838987 565291	233,00 ,0,00
	CKM 120-150	podnožje kopalne kadi za oblogo podnožje kupaonske kade za oblogu	3838987 573043	159,00
	Vodni masažni sistem I. Vodeni masažni sistem I. PNEVMATSKI Dolores 140x140	z oblogo s oblogom z oblogo + mikrošobe s oblogom + mikromlaznice	3838987 927563 3838987 927570	1.759,00 2.298,00
	Kombinirani (vodni in zračni) masažni sistem / Kombinirani (vodeni i zračni) masažni sistem ELEKTRONSKI Dolores 140x140	z oblogo s oblogom z oblogo + mikrošobe s oblogom + mikromlaznice	3838987 927587 3838987 927594	2.917,00 3.456,00
	Vital masažni sistem Vital masažni sistem ELEKTRONSKI Dolores 140x140	z oblogo + mikrošobe s oblogom + mikromlaznice	3838987 927600	4.432,00
Vgradnja mikrošob v kad Ugradnja mikromlaznica u kadu Dolores 140x140				
	Prikaz vgradnje mikrošob Prikaz ugradnje mikromlaznica Dolores 140x140			

Kopalne in masažne kadi

Kade za kupanje i masažne kade

Program:

kolpa·san
BY KOLPA

Model	Naziv in dimenzija izdelka Naziv i dimenzije produkta	Opis Opis	EAN koda EAN koda	Cena EUR Cijena EUR
Dodatki za / Dodaci za Dolores 140x140				
	GEYSER 	enoročna arm. s tuš ročico in polnilno /odlivno prelivno gar. za polnjenje kadi jednoručna arm. s tuš ručicom i priljev/odljev prelivnom garnituroom za punjenje kada	3838987 506287	603,00
	RAINDROP 	enoročna armatura s tuš ročico in izlivom / jednoručna armatura s tuš ručicom i izljevom	3838987 726500	590,00
	UP&DOWN, WHITE	prelivna garnitura s sifonom, bela preljevna garnitura sa sifonom, bijela	3838987 922759	62,00
	PAL 650	prelivna garnitura s sifonom preljevna garnitura sa sifonom	3838987 746270	55,00
	HEADREST SOFT	vzglavnik naslon za glavu	3838987 593942	79,00
	HEADREST COAST	vzglavnik naslon za glavu	3838987 593928	103,00
	1001/B	podnožje kopalne kadi za vgradnjo podnožje kupaonske kade za ugradnju	3838987 876502	49,00
	Zidni montažni set Zidni montažni set	za kopalne in tuš kadi za vgradnjo za kupaonske i tuš kade za ugradnju	3838987 704362	11,00
	Suhomontažna zaključna letva Završna letva u sistemu suhe montaže	karton 25 kosov / karton 25 komada (Cena za kos / Cijena na komad 30,60 EUR)	3838987 903116	765,00
	Chromotherapy (CTL) Chromotherapy (CTL)	2 LED lučki s samostojno tipkovnicom 2 LED svjetla sa samostalnom tipkovnicom		382,00
	Dve dodatni mikro šobi Dvije dodatne mikro mlaznice	za masažo stopal (kpl) za masažu stopala (kpl)		61,00
	Servisno prezračevalni pokrov z rešetko Servisno ventilacijski pokrov s rešetkom	za masažne kadi za vgradnjo (45x45 cm) za masažne kade za ugradnju (45x45 cm)	3838987 534808	90,00
	ANTI-SLIP PREMAZ	protizdrsni premaz za kopalne kadi protiv klizni premaz za kupaonske kade (min. kol. 10 kos)		67,00
	Specialno čistilo KOLPA SAN Specialno sredstvo za čišćenje	karton 20 kosov / karton 20 komada (Cena za kos / Cijena na komad 6,20 EUR)	3838987 747291	124,00
	Specialno čistilo ECO SAN Specialno sredstvo za čišćenje	karton 20 kosov / karton 20 komada (Cena za kos / Cijena na komad 5,40 EUR)	3838987 572220	108,00
	Čistilo za masažne sisteme Sredstvo za čišćenje masažnih sistema	karton 10 kosov / karton 10 komada (Cena za kos / Cijena na komad 7,80 EUR)	3838987 747277	78,00



Kopalne in masažne kadi

Kade za kupanje i masažne kade











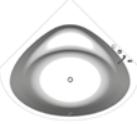

Program:kolpa·san[®]

Model	Naziv in dimenzija izdelka Naziv i dimenzije produkta	Opis Opis	EAN koda EAN koda	Cena EUR Cijena EUR
Dolores 130x130				
	Dolores 130x130	kopalna kad za vgradnjo kada za ugradnju	3838987 565482	343,00
	Obloga Dolores 130	obloga za kopalno kad obloga za kupaonsku kadu	3838987 565499	199,00
	CKM 120-150	podnožje kopalne kadi za oblogo podnožje kupaonske kade za oblogu	3838987 573043	159,00

Kopalne in masažne kadi

Kade za kupanje i masažne kade

Program:kolpa·san[®]

Model	Naziv in dimenzija izdelka Naziv i dimenzije produkta	Opis Opis	EAN koda EAN koda	Cena EUR Cijena EUR
Dodatki za / Dodaci za Dolores 130x130				
	GEYSER 	enoročna arm. s tuš ročico in polnilno /odlivno prelivno gar. za polnjenje kadi jednoručna arm. s tuš ručicom i priljev/odljev prelivnom garniturom za punjenje kada	3838987 506287	603,00
	RAINDROP 	enoročna armatura s tuš ročico in izlivom / jednoručna armatura s tuš ručicom i izljevom	3838987 726500	590,00
	UP&DOWN, WHITE	prelivna garnitura s sifonom, bela preljevna garnitura sa sifonom, bijela	3838987 922759	62,00
	PAL 650	prelivna garnitura s sifonom preljevna garnitura sa sifonom	3838987 746270	55,00
	HEADREST SOFT	vzglavnik naslon za glavu	3838987 593942	79,00
	HEADREST COAST	vzglavnik naslon za glavu	3838987 593928	103,00
	1001/B	podnožje kopalne kadi za vgradnjo podnožje kupaonske kade za ugradnju	3838987 876502	49,00
	Zidni montažni set Zidni montažni set	za kopalne in tuš kadi za vgradnjo za kupaonske i tuš kade za ugradnju	3838987 704362	11,00
	Suhomontažna zaključna letva Završna letva u sistemu suhe montaže	karton 25 kosov / karton 25 komada (Cena za kos / Cijena na komad 30,60 EUR)	3838987 903116	765,00
	Servisno prezračevalni pokrov z rešetko Servisno ventilacijski pokrov s rešetkom	za masažne kadi za vgradnjo (45x45 cm) za masažne kade za ugradnju (45x45 cm)	3838987 534808	90,00
	ANTI-SLIP PREMAZ	protizdrski premaz za kopalne kadi protiv klizni premaz za kupaonske kade (min. kol. 10 kos)		67,00
	Specialno čištilo KOLPA SAN Specialno sredstvo za čišćenje	karton 20 kosov / karton 20 komada (Cena za kos / Cijena na komad 6,20 EUR)	3838987 747291	124,00
	Specialno čištilo ECO SAN Specialno sredstvo za čišćenje	karton 20 kosov / karton 20 komada (Cena za kos / Cijena na komad 5,40 EUR)	3838987 572220	108,00



Kopalne in masažne kadi

Kade za kupanje i masažne kade

Program:kolpa·san[®]















Model	Naziv in dimenzija izdelka Naziv i dimenzije produkta	Opis Opis	EAN koda EAN koda	Cena EUR Cijena EUR
Divante 140x140				
	Divante 140x140	kopalna kad za vgradnjo kada za ugradnju	3838987 753704	251,00
	Obloga Divante 140	obloga za kopalno kad obloga za kupaonsku kadu	3838987 754022	104,00
	CD 140	podnožje kopalne kadi za oblogo podnožje kupaonske kade za oblogu	3838987 760115	132,00
	Vodni masažni sistem I. Vodeni masažni sistem I. PNEVMATSKI Divante 140x140	z oblogo / s oblogom	3838987 590743	1.033,00

Kopalne in masažne kadi

Kade za kupanje i masažne kade

Program:

kolpa·san
BY KOLPA

Model	Naziv in dimenzija izdelka Naziv i dimenzije produkta	Opis Opis	EAN koda EAN koda	Cena EUR Cijena EUR
Dodatki za / Dodaci za Divante 140x140				
	WATERFALL 	enoročna armatura s tuš ročico in izlivom / jednoručna armatura s tuš ručicom i izljevom	3838987 734543	562,00
	GEYSER 	enoročna arm. s tuš ročico in polnilno /odlivno prelivno gar. za polnjenje kadi jednoručna arm. s tuš ručicom i priljev/odljev preljevnom garnituroom za punjenje kada	3838987 506287	603,00
	RAINDROP 	enoročna armatura s tuš ročico in izlivom / jednoručna armatura s tuš ručicom i izljevom	3838987 726500	590,00
	UP&DOWN, WHITE	prelivna garnitura s sifonom, bela preljevna garnitura sa sifonom, bijela	3838987 922759	62,00
	PAL 450	prelivna garnitura s sifonom preljevna garnitura sa sifonom	3838987 746263	40,00
	HEADREST SOFT	vzglavnik naslon za glavu	3838987 593942	79,00
	HEADREST COAST		3838987 593928	103,00
	1001/L	podnožje kopalne kadi za vgradnjo podnožje kupaonske kade za ugradnju	3838987 773375	49,00
	TP 102/K UNI SOLE, Silver	dvodelni krilni zaslon za kopalno kad Divante dvodijelni krilni zaslon za kupaonksu kadu Divante	3838987 514800	299,00
	TP 105 QUAT Bela		3838987 314356	153,00
	Zidni montažni set Zidni montažni set	za kopalne in tuš kadi za vgradnjo za kupaonske i tuš kade za ugradnju	3838987 704362	11,00
	Suhomontažna zaključna letav Završna letva u sistemu suhe montaže	karton 25 kosov / karton 25 komada (Cena za kos / Cijena na komad 30,60 EUR)	3838987 903116	765,00
	Servisno prezračevalni pokrov z rešetko Servisno ventilacijski pokrov s rešetkom	za masažne kadi za vgradnjo (45x45 cm) za masažne kade za ugradnju (45x45 cm)	3838987 534808	90,00
	ANTI-SLIP PREMAZ	protizdrsnni premaz za kopalne kadi protiv klizni premaz za kupaonske kade (min. kol. 10 kos)		67,00
	Specialno čistoilo KOLPA SAN Specialno sredstvo za čišćenje	karton 20 kosov / karton 20 komada (Cena za kos / Cijena na komad 6,20 EUR)	3838987 747291	124,00
	Specialno čistoilo ECO SAN Specialno sredstvo za čišćenje	karton 20 kosov / karton 20 komada (Cena za kos / Cijena na komad 5,40 EUR)	3838987 572220	108,00
	Čistilo za masažne sisteme Sredstvo za čišćenje masažnih sistema	karton 10 kosov / karton 10 komada (Cena za kos / Cijena na komad 7,80 EUR)	3838987 747277	78,00



Kopalne in masažne kadi

Kade za kupanje i masažne kade

Program:kolpa·san[®]











Model	Naziv in dimenzija izdelka Naziv i dimenzije produkta	Opis Opis	EAN koda EAN koda	Cena EUR Cijena EUR
Royal 130x130				
	Royal 130x130	kotna kopalna kad za vgradnjo kutna kada za ugradnju	3838987 705192	309,00
	Obloga Royal 130	obloga za kopalno kad obloga za kupaonsku kadu	3838987 911906	133,00
	CKM 120-150	podnožje kopalne kadi za oblogo podnožje kupaonske kade za oblogo	3838987 573043	159,00
	Vodni masažni sistem I. Vodeni masažni sistem I. PNEVMATSKI Royal 130x130	z oblogo / s oblogom	3838987 908517	1.422,00
	Kombinirani (vodni in zračni) masažni sistem / Kombinirani (vodeni i zračni) masažni sistem ELEKTRONSKI Royal 130x130	z oblogo / s oblogom	3838987 591474	2.636,00

Kopalne in masažne kadi

Kade za kupanje i masažne kade

Program:

kolpa·san®

Model	Naziv in dimenzija izdelka Naziv i dimenzije produkta	Opis Opis	EAN koda EAN koda	Cena EUR Cijena EUR
Dodatki za / Dodaci za Royal 130x130				
	UP&DOWN, WHITE	prelivna garnitura s sifonom, bela prelivna garnitura sa sifonom, bijela	3838987 922759	62,00
	PAL 450	prelivna garnitura s sifonom prelivna garnitura sa sifonom	3838987 746263	40,00
	HEADREST COAST	vzglavnik naslon za glavu	3838987 593928	103,00
	1001/L	podnožje kopalne kadi za vgradnjo podnožje kupaonske kade za ugradnju	3838987 773375	49,00
	TP 102/K UNI SOLE, Silver	dvodelni krilni zaslon za kopalno kad Royal dvodijelni krilni zaslon za kupaonksu kadu Royal	3838987 514800	299,00
	TP 105 QUAT Bela		3838987 314356	153,00
	Zidni montažni set Zidni montažni set	za kopalne in tuš kadi za vgradnjo za kupaonske i tuš kade za ugradnju	3838987 704362	11,00
	Suhomontažna zaključna letva Završna letva u sistemu suhe montaže	karton 25 kosov / karton 25 komada (Cena za kos / Cijena na komad 30,60 EUR)	3838987 903116	765,00
	Chromotherapie (CTL) Chromotherapie (CTL)	2 LED lučki s samostojno tipkovnico 2 LED svjetla sa samostalnom tipkovnicom		382,00
	Dve dodatni mikro šobi Dvije dodatne mikro mlaznice	za masažo stopal (kpl) za masažu stopala (kpl)		61,00
	Servisno prezračevalni pokrov z rešetko Servisna ventilacijski pokrov s rešetkom	za masažne kadi za vgradnjo (45x45 cm) za masažne kade za ugradnju (45x45 cm)	3838987 534808	90,00
	ANTI-SLIP PREMAZ	protizdrsni premaz za kopalne kadi protiv klizni premaz za kupaonske kade (min. kol. 10 kos)		67,00
	Specialno čistilo KOLPA SAN Specialno sredstvo za čišćenje	karton 20 kosov / karton 20 komada (Cena za kos / Cijena na komad 6,20 EUR)	3838987 747291	124,00
	Specialno čistilo ECO SAN Specialno sredstvo za čišćenje	karton 20 kosov / karton 20 komada (Cena za kos / Cijena na komad 5,40 EUR)	3838987 572220	108,00
	Čistilo za masažne sisteme Sredstvo za čišćenje masažnih sistema	karton 10 kosov / karton 10 komada (Cena za kos / Cijena na komad 7,80 EUR)	3838987 747277	78,00



Kopalne in masažne kadi

Kade za kupanje i masažne kade

Program:kolpa·san[®]









Model	Naziv in dimenzija izdelka Naziv i dimenzije produkta	Opis Opis	EAN koda EAN koda	Cena EUR Cijena EUR
Royal 120x120				
	Royal 120x120	kotna kopalna kad za vgradnjo kutna kada za ugradnju	3838987 731184	301,00
	Obloga Royal 120	obloga za kopalno kad obloga za kupaonsku kadu	3838987 739142	133,00
	CKM 120-150	podnožje kopalne kadi za oblogo podnožje kupaonske kade za oblogo	3838987 573043	159,00

Kopalne in masažne kadi







Kade za kupanje i masažne kade

Program:

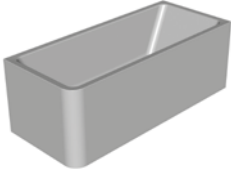
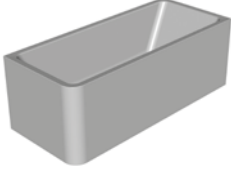
kolpa·san®

Model	Naziv in dimenzija izdelka Naziv i dimenzije produkta	Opis Opis	EAN koda EAN koda	Cena EUR Cijena EUR
Dodatki za / Dodaci za Royal 120x120				
	UP&DOWN, WHITE	prelivna garnitura s sifonom, bela prelivna garnitura sa sifonom, bijela	3838987 922759	62,00
	PAL 450	prelivna garnitura s sifonom prelivna garnitura sa sifonom	3838987 746263	40,00
	HEADREST COAST	vzglavnik naslon za glavu	3838987 593928	103,00
	1001/L	podnožje kopalne kadi za vgradnjo podnožje kupaonske kade za ugradnju	3838987 773375	49,00
	TP 102/K UNI SOLE, Silver	dvodelni krilni zaslon za kopalno kad Royal dvodijelni krilni zaslon za kupaonksu kado Royal	3838987 514800	299,00
	TP 105 QUAT Bela		3838987 314356	153,00
	Zidni montažni set Zidni montažni set	za kopalne in tuš kadi za vgradnjo za kupaonske i tuš kade za ugradnju	3838987 704362	11,00
	Suhomontažna zaključna letva Završna letva u sistemu suhe montaže	karton 25 kosov / karton 25 komada (Cena za kos / Cijena na komad 30,60 EUR)	3838987 903116	765,00
	Servisno prezračevalni pokrov z rešetko Servisno ventilacijski pokrov s rešetkom	za masažne kadi za vgradnjo (45x45 cm) za masažne kade za ugradnju (45x45 cm)	3838987 534808	90,00
	ANTI-SLIP PREMAZ	protizdrsni premaz za kopalne kadi protiv klizni premaz za kupaonske kade (min. kol. 10 kos)		67,00
	Specialno čistilo KOLPA SAN Specialno sredstvo za čišćenje	karton 20 kosov / karton 20 komada (Cena za kos / Cijena na komad 6,20 EUR)	3838987 747291	124,00
	Specialno čistilo ECO SAN Specialno sredstvo za čišćenje	karton 20 kosov / karton 20 komada (Cena za kos / Cijena na komad 5,40 EUR)	3838987 572220	116,00







Kopalne in masažne kadi Kade za kupanje i masažne kade		Program: kolpa·san®		
Model	Naziv in dimenzija izdelka Naziv i dimenzije produkta	Opis Opis	EAN koda EAN koda	Cena EUR Cijena EUR
Elektra-SP-L 185, 175				
	Elektra-SP-L 185x85	kopalna kad s prelivno garnituro - kad in obloga iz enega dela kada s prelivnom garniturom - kada i obloga su iz jednog dijela	3838987 513476	1.196,00
	Elektra-SP-L 175x75	kopalna kad s prelivno garnituro - kad in obloga iz enega dela kada s prelivnom garniturom - kada i obloga su iz jednog dijela	3838987 513506	1.158,00
Dodatki za / Dodaci za Elektra-SP-L 185, 175				
	HEADREST SOFT	vzglavnik naslon za glavu	3838987 593942	79,00
	HEADREST COAST		3838987 593928	103,00
	Suhomontažna zaključna letev Završna letva u sistemu suhe montaže	karton 25 kosov / karton 25 komada (Cena za kos / Cijena na komad 30,60 EUR)	3838987 903116	765,00
	ANTI-SLIP PREMAZ	protizdrsni premaz za kopalne kadi protiv klizni premaz za kupaonske kade (min. kol. 10 kos)		67,00
	Specialno čištilo KOLPA SAN Specialno sredstvo za čišćenje	karton 20 kosov / karton 20 komada (Cena za kos / Cijena na komad 6,20 EUR)	3838987 747291	124,00
	Specialno čištilo ECO SAN Specialno sredstvo za čišćenje	karton 20 kosov / karton 20 komada (Cena za kos / Cijena na komad 5,40 EUR)	3838987 572220	108,00



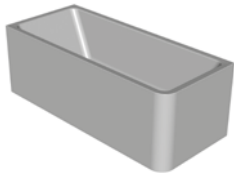
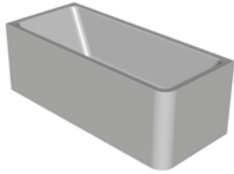
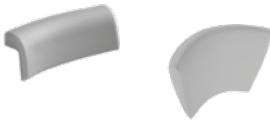













Kopalne in masažne kadi

Kade za kupanje i masažne kade

Program:kolpa·san[®]

Model	Naziv in dimenzija izdelka Naziv i dimenzije produkta	Opis Opis	EAN koda EAN koda	Cena EUR Cijena EUR
Elektra-SP-D 185, 175				
	Elektra-SP-D 185x85	kopalna kad s prelivno garnituro - kad in obloga iz enega dela kada s preljevnom garniturom - kada i obloga su iz jednog dijela	3838987 513483	1.196,00
	Elektra-SP-D 175x75	kopalna kad s prelivno garnituro - kad in obloga iz enega dela kada s preljevnom garniturom - kada i obloga su iz jednog dijela	3838987 513513	1.158,00
Dodatki za / Dodaci za Elektra-SP-D 185, 175				
	HEADREST SOFT	vzglavnik naslon za glavu	3838987 593942	79,00
	HEADREST COAST		3838987 593928	103,00
	Suhomontažna zaključna letev Završna letva u sistemu suhe montaže	karton 25 kosov / karton 25 komada (Cena za kos / Cijena na komad 30,60 EUR)	3838987 903116	765,00
	ANTI-SLIP PREMAZ	protizdrsni premaz za kopalne kadi protiv klizni premaz za kupaonske kade (min. kol. 10 kos)		67,00
	Specialno čištilo KOLPA SAN Specialno sredstvo za čišćenje	karton 20 kosov / karton 20 komada (Cena za kos / Cijena na komad 6,20 EUR)	3838987 747291	124,00
	Specialno čištilo ECO SAN Specialno sredstvo za čišćenje	karton 20 kosov / karton 20 komada (Cena za kos / Cijena na komad 5,40 EUR)	3838987 572220	108,00

















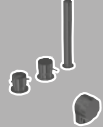

Kopalne in masažne kadi Kade za kupanje i masažne kade		Program: kolpa·san®		
Model	Naziv in dimenzija izdelka Naziv i dimenzije produkta	Opis Opis	EAN koda EAN koda	Cena EUR Cijena EUR
Dream-SP-L 180, 170				
	Dream-SP-L 180x80	kopalna kad s prelivno garnituro - kad in obloga iz enega dela kada s preljevnom garniturom - kada i obloga su iz jednog dijela	3838987 574361	1.083,00
	Dream-SP-L 170x75	kopalna kad s prelivno garnituro - kad in obloga iz enega dela kada s preljevnom garniturom - kada i obloga su iz jednog dijela	3838987 518037	1.034,00
Dodatki za / Dodaci za				
Dream-SP-L 180, 170				
180x80 	170x75 	WATERFALL 	enoročna armatura s tuš ročico in izlivom / jednoručna armatura s tuš ručicom i izljevom	3838987 734543 562,00
180x80 	170x75 	GEYSER 	enoročna arm. s tuš ročico in polnilno /odlivno prelivno gar. za polnjenje kadi jednoručna arm. s tuš ručicom i priljev/odljev preljevnom garniturom za punjenje kada	3838987 506287 603,00
180x80 	170x75 	RAINDROP 	enoročna armatura s tuš ročico in izlivom / jednoručna armatura s tuš ručicom i izljevom	3838987 726500 590,00
		HEADREST SOFT	vzglavnik naslon za glavu	3838987 593942 79,00
		HEADREST COAST		3838987 593928 103,00
		Suhomontažna zaključna letva Završna letva u sistemu suhe montaže	karton 25 kosov / karton 25 komada (Cena za kos / Cijena na komad 30,60 EUR)	3838987 903116 765,00
		Chromoterapia (CTL) Chromoterapia (CTL)	2 LED lučki s samostojno tipkovnico 2 LED svjetla sa samostalnom tipkovnicom	382,00
		ANTI-SLIP PREMAZ	protizdrsni premaz za kopalne kadi protiv klizni premaz za kupaonske kade (min. kol. 10 kos)	67,00
		Specialno čištilo KOLPA SAN Specialno sredstvo za čišćenje Specialno čištilo ECO SAN Specialno sredstvo za čišćenje	karton 20 kosov / karton 20 komada (Cena za kos / Cijena na komad 6,20 EUR) karton 20 kosov / karton 20 komada (Cena za kos / Cijena na komad 5,40 EUR)	124,00 108,00

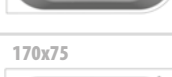
Kopalne in masažne kadi

Kade za kupanje i masažne kade

Program:

kolpa·san
BY KOLPA

Model	Naziv in dimenzija izdelka Naziv i dimenzije produkta	Opis Opis	EAN koda EAN koda	Cena EUR Cijena EUR	
Dream-SP-D 180, 170					
	Dream-SP-D 180x80	kopalna kad s prelivno garnituro - kad in obloga iz enega dela kada s preljevnom garniturom - kada i obloga su iz jednog dijela	3838987 574378	1.083,00	
	Dream-SP-D 170x75	kopalna kad s prelivno garnituro - kad in obloga iz enega dela kada s preljevnom garniturom - kada i obloga su iz jednog dijela	3838987 518044	1.034,00	
Dodatki za / Dodaci za Dream-SP-D 180, 170					
180x80 	170x75 	WATERFALL 	enoročna armatura s tuš ročico in izlivom / jednoručna armatura s tuš ručicom i izljevom	3838987 734543	562,00
180x80 	170x75 	GEYSER 	enoročna arm. s tuš ročico in polnilno /odlivno prelivno gar. za polnjenje kadi jednoručna arm. s tuš ručicom i priljev/odljev preljevnom garniturom za punjenje kada	3838987 506287	603,00
180x80 	170x75 	RAINDROP 	enoročna armatura s tuš ročico in izlivom / jednoručna armatura s tuš ručicom i izljevom	3838987 726500	590,00
		HEADREST SOFT	vzglavnik naslon za glavu	3838987 593942	79,00
		HEADREST COAST		3838987 593928	103,00
		Suhomontažna zaključna letva Završna letva u sistemu suhe montaže	karton 25 kosov / karton 25 komada (Cena za kos / Cijena na komad 30,60 EUR)	3838987 903116	765,00
		Chromoterapia (CTL) Chromoterapia (CTL)	2 LED lučki s samostojno tipkovnicom 2 LED svjetla sa samostalnom tipkovnicom		382,00
		ANTI-SLIP PREMAZ	protizdrsni premaz za kopalne kadi protiv klizni premaz za kupaonske kade (min. kol. 10 kos)		67,00
		Specialno čištilo KOLPA SAN Specialno sredstvo za čišćenje Specialno čištilo ECO SAN Specialno sredstvo za čišćenje	karton 20 kosov / karton 20 komada (Cena za kos / Cijena na komad 6,20 EUR) karton 20 kosov / karton 20 komada (Cena za kos / Cijena na komad 5,40 EUR)	3838987 747291 3838987 572220	124,00 108,00



Kopalne in masažne kadi

Kade za kupanje i masažne kade











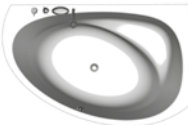

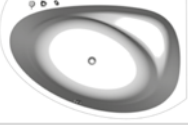

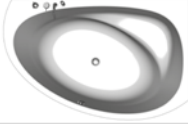
Program:kolpa·san[®]

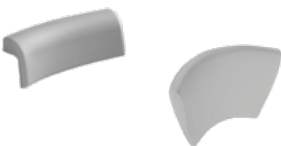
Model	Naziv in dimenzija izdelka Naziv i dimenzije produkta	Opis Opis	EAN koda EAN koda	Cena EUR Cijena EUR
Libretto-L 170x110				
	Libretto-L 170x110	kopalna kad za vgradnjo kada za ugradnju	3838987 565246	318,00
	Obloga Libretto 170 - L	obloga za kopalno kad - leva obloga za kupaonsku kadu - lijeva	3838987 565260	181,00
	CKM 120-150	podnožje kopalne kadi za oblogo podnožje kupaonske kade za oblogu	3838987 573043	159,00
	Vodni masažni sistem I. Vodeni masažni sistem I. PNEVMATSKI Libretto-L 170x110	z oblogo s oblogom z oblogo + mikrošobe s oblogom + mikromlaznice	3838987 927457 3838987 927464	1.393,00 1.932,00
	Kombinirani (vodni in zračni) masažni sistem / Kombinirani (vodeni i zračni) masažni sistem ELEKTRONSKI Libretto-L 170x110	z oblogo s oblogom z oblogo + mikrošobe s oblogom + mikromlaznice	3838987 927471 3838987 927488	2.611,00 3.150,00
	Vital masažni sistem Vital masažni sistem ELEKTRONSKI Libretto-L 170x110	z oblogo + mikrošobe s oblogom + mikromlaznice	3838987 927495	4.163,00
Vgradnja mikrošob v kad Ugradnja mikromlaznica u kadu Libretto-L 170x110				
	Prikaz vgradnje mikrošob Prikaz ugradnje mikromlaznica Libretto-L 170x110			

Kopalne in masažne kadi

Kade za kupanje i masažne kade

Program:kolpa·san[®]

Model	Naziv in dimenzija izdelka Naziv i dimenzije produkta	Opis Opis	EAN koda EAN koda	Cena EUR Cijena EUR
Dodatki za / Dodaci za Libretto-L 170x110				
	WATERFALL 	enoročna armatura s tuš ročico in izlivom / jednoručna armatura s tuš ručicom i izljevom	3838987 734543	562,00
	GEYSER 	enoročna arm. s tuš ročico in polnilno /odlivno prelivno gar. za polnjenje kadi jednoručna arm. s tuš ručicom i priljev/odljev prelivnom garnituroom za punjenje kade	3838987 506287	603,00
	RAINDROP 	enoročna armatura s tuš ročico in izlivom / jednoručna armatura s tuš ručicom i izljevom	3838987 726500	590,00
	UP&DOWN, WHITE	prelivna garnitura s sifonom, bela prelivna garnitura sa sifonom, bijela	3838987 922759	62,00
	PAL 650	prelivna garnitura s sifonom prelivna garnitura sa sifonom	3838987 746270	55,00
	HEADREST SOFT	vzglavnik naslon za glavu	3838987 593942	79,00
	HEADREST COAST	vzglavnik naslon za glavu	3838987 593928	103,00
	PKK 501	podnožje kopalne kadi za vgradnjo podnožje kupaonske kade za ugradnju	3838987 764878	28,00
	Zidni montažni set Zidni montažni set	za kopalne in tuš kadi za vgradnjo za kupaonske i tuš kade za ugradnju	3838987 704362	11,00
	Suhomontažna zaključna letva Završna letva u sistemu suhe montaže	karton 25 kosov / karton 25 komada (Cena za kos / Cijena na komad 30,60 EUR)	3838987 903116	765,00
	Chromotherapia (CTL) Chromotherapia (CTL)	2 LED lučki s samostojno tipkovnico 2 LED svjetla sa samostalnom tipkovnicom		382,00
	Dve dodatni mikro šobi Dvije dodatne mikro mlaznice	za masažo stopal (kpl) za masažu stopala (kpl)		61,00
	Servisno prezračevalni pokrov z rešetko Servisno ventilacijski pokrov s rešetkom	za masažne kadi za vgradnjo (45x45 cm) za masažne kade za ugradnju (45x45 cm)	3838987 534808	90,00
	ANTI-SLIP PREMAZ	protizdrsni premaz za kopalne kadi protiv klizni premaz za kupaonske kade (min. kol. 10 kos)		67,00
	Specijalno čištilo KOLPA SAN Specijalno sredstvo za čišćenje	karton 20 kosov / karton 20 komada (Cena za kos / Cijena na komad 6,20 EUR)	3838987 747291	124,00
	Specijalno čištilo ECO SAN Specijalno sredstvo za čišćenje	karton 20 kosov / karton 20 komada (Cena za kos / Cijena na komad 5,40 EUR)	3838987 572220	108,00
	Čištilo za masažne sisteme Sredstvo za čišćenje masažnih sistema	karton 10 kosov / karton 10 komada (Cena za kos / Cijena na komad 7,80 EUR)	3838987 747277	78,00



Kopalne in masažne kadi

Kade za kupanje i masažne kade

Program:kolpa·san[®]

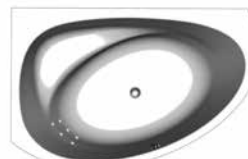









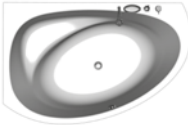

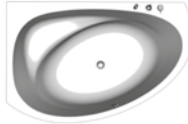

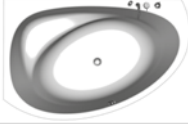

Model	Naziv in dimenzija izdelka Naziv i dimenzije produkta	Opis Opis	EAN koda EAN koda	Cena EUR Cijena EUR
Libretto-D 170x110				
	Libretto-D 170x110	kopalna kad za vgradnjo kada za ugradnju	3838987 565253	318,00
	Obloga Libretto 170 -D	obloga za kopalno kad - desna obloga za kupaonsku kadu - desna	3838987 565277	181,00
	CKM 120-150	podnožje kopalne kadi za oblogo podnožje kupaonske kade za oblogu	3838987 573043	159,00
	Vodni masažni sistem I. Vodeni masažni sistem I. PNEVMATSKI Libretto-D 170x110	z oblogo s oblogom z oblogo + mikrošobe s oblogom + mikromlaznice	3838987 927501 3838987 927518	1.393,00 1.932,00
	Kombinirani (vodni in zračni) masažni sistem / Kombinirani (vodeni i zračni) masažni sistem ELEKTRONSKI Libretto-D 170x110	z oblogo s oblogom z oblogo + mikrošobe s oblogom + mikromlaznice	3838987 927525 3838987 927532	2.611,00 3.150,00
	Vital masažni sistem Vital masažni sistem ELEKTRONSKI Libretto-D 170x110	z oblogo + mikrošobe s oblogom + mikromlaznice	3838987 927549	4.163,00
Vgradnja mikrošob v kad Ugradnja mikromlaznica u kadu Libretto-D 170x110				
	Prikaz vgradnje mikrošob Prikaz ugradnje mikromlaznica Libretto-D 170x110			

Kopalne in masažne kadi

Kade za kupanje i masažne kade

Program:

kolpa·san
BY KOLPA

Model	Naziv in dimenzija izdelka Naziv i dimenzije produkta	Opis Opis	EAN koda EAN koda	Cena EUR Cijena EUR
Dodatki za / Dodaci za Libretto-D 170x110				
	WATERFALL 	enoročna armatura s tuš ročico in izlivom / jednoručna armatura s tuš ručicom i izljevom	3838987 734543	562,00
	GEYSER 	enoročna arm. s tuš ročico in polnilno /odlivno prelivno gar. za polnjenje kadi jednoručna arm. s tuš ručicom i priljev/odljev prelivnom garniturom za punjenje kade	3838987 506287	603,00
	RAINDROP 	enoročna armatura s tuš ročico in izlivom / jednoručna armatura s tuš ručicom i izljevom	3838987 726500	590,00
	UP&DOWN, WHITE	prelivna garnitura s sifonom, bela prelivna garnitura sa sifonom, bijela	3838987 922759	62,00
	PAL 650	prelivna garnitura s sifonom prelivna garnitura sa sifonom	3838987 746270	55,00
	HEADREST SOFT	vzglavnik naslon za glavu	3838987 593942	79,00
	HEADREST COAST	vzglavnik naslon za glavu	3838987 593928	103,00
	PKK 501	podnožje kopalne kadi za vgradnjo podnožje kupaonske kade za ugradnju	3838987 764878	28,00
	Zidni montažni set Zidni montažni set	za kopalne in tuš kadi za vgradnjo za kupaonske i tuš kade za ugradnju	3838987 704362	11,00
	Suhomontažna zaključna letva Završna letva u sistemu suhe montaže	karton 25 kosov / karton 25 komada (Cena za kos / Cijena na komad 30,60 EUR)	3838987 903116	765,00
	Chromoterapia (CTL) Chromoterapia (CTL)	2 LED lučki s samostojno tipkovnicom 2 LED svjetla sa samostalnom tipkovnicom		382,00
	Dve dodatni mikro šobi Dvije dodatne mikro mlaznice	za masažo stopal (kpl) za masažu stopala (kpl)		61,00
	Servisno prezračevalni pokrov z rešetko Servisno ventilacijski pokrov s rešetkom	za masažne kadi za vgradnjo (45x45 cm) za masažne kade za ugradnju (45x45 cm)	3838987 534808	90,00
	ANTI-SLIP PREMAZ	protizdrsni premaz za kopalne kadi protiv klizni premaz za kupaonske kade (min. kol. 10 kos)		67,00
	Specijalno čištilo KOLPA SAN Specijalno sredstvo za čišćenje	karton 20 kosov / karton 20 komada (Cena za kos / Cijena na komad 6,20 EUR)	3838987 747291	124,00
	Specijalno čištilo ECO SAN Specijalno sredstvo za čišćenje	karton 20 kosov / karton 20 komada (Cena za kos / Cijena na komad 5,40 EUR)	3838987 572220	108,00
	Čištilo za masažne sisteme Sredstvo za čišćenje masažnih sistema	karton 10 kosov / karton 10 komada (Cena za kos / Cijena na komad 7,80 EUR)	3838987 747277	78,00



Kopalne in masažne kadi

Kade za kupanje i masažne kade











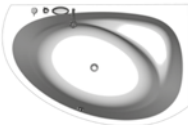

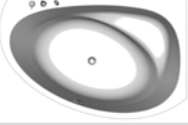

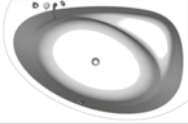
Program:kolpa·san®
BY KOLPA

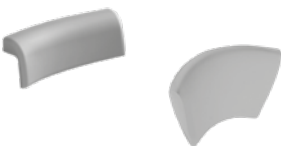
Model	Naziv in dimenzija izdelka Naziv i dimenzije produkta	Opis Opis	EAN koda EAN koda	Cena EUR Cijena EUR
Libretto-L 160x100				
	Libretto-L 160x100	kopalna kad za vgradnjo kada za ugradnju	3838987 574736	304,00
	Obloga Libretto 160 - L	obloga za kopalno kad - leva obloga za kupaonsku kadu - lijeva	3838987 565581	174,00
	CKM 120-150	podnožje kopalne kadi za oblogo podnožje kupaonske kade za oblogu	3838987 573043	159,00
	Vodni masažni sistem I. Vodeni masažni sistem I. PNEVMATSKI Libretto-L 160x100	z oblogo s oblogom z oblogo + mikrošobe s oblogom + mikromlaznice	3838987 927358 3838987 927365	1.380,00 1.920,00
	Kombinirani (vodni in zračni) masažni sistem / Kombinirani (vodeni i zračni) masažni sistem ELEKTRONSKI Libretto-L 160x100	z oblogo s oblogom z oblogo + mikrošobe s oblogom + mikromlaznice	3838987 927372 3838987 927389	2.598,00 3.137,00
	Vital masažni sistem Vital masažni sistem ELEKTRONSKI Libretto-L 160x100	z oblogo + mikrošobe s oblogom + mikromlaznice	3838987 927396	4.151,00
Vgradnja mikrošob v kad Ugradnja mikromlaznica u kadu Libretto-L 160x100				
	Prikaz vgradnje mikrošob Prikaz ugradnje mikromlaznica Libretto-L 160x100			

Kopalne in masažne kadi
Kade za kupanje i masažne kade

Program:

kolpa·san
BY KOLPA

Model	Naziv in dimenzija izdelka Naziv i dimenzije produkta	Opis Opis	EAN koda EAN koda	Cena EUR Cijena EUR
Dodatki za / Dodaci za Libretto-L 160x100				
	WATERFALL 	enoročna armatura s tuš ročico in izlivom / jednoručna armatura s tuš ručicom i izljevom	3838987 734543	562,00
	GEYSER 	enoročna arm. s tuš ročico in polnilno /odlivno prelivno gar. za polnjenje kadi jednoručna arm. s tuš ručicom i priljev/odljev prelivnom garniturom za punjenje kade	3838987 506287	603,00
	RAINDROP 	enoročna armatura s tuš ročico in izlivom / jednoručna armatura s tuš ručicom i izljevom	3838987 726500	590,00
	UP&DOWN, WHITE	prelivna garnitura s sifonom, bela prelivna garnitura sa sifonom, bijela	3838987 922759	62,00
	PAL 650	prelivna garnitura s sifonom prelivna garnitura sa sifonom	3838987 746270	55,00
	HEADREST SOFT	vzglavnik naslon za glavu	3838987 593942	79,00
	HEADREST COAST	vzglavnik naslon za glavu	3838987 593928	103,00
	PKK 501	podnožje kopalne kadi za vgradnjo podnožje kupaonske kade za ugradnju	3838987 764878	28,00
	Zidni montažni set Zidni montažni set	za kopalne in tuš kadi za vgradnjo za kupaonske i tuš kade za ugradnju	3838987 704362	11,00
	Suhomontažna zaključna letva Završna letva u sistemu suhe montaže	karton 25 kosov / karton 25 komada (Cena za kos / Cijena na komad 30,60 EUR)	3838987 903116	765,00
	Chromoterapia (CTL) Chromoterapia (CTL)	2 LED lučki s samostojno tipkovnico 2 LED svjetla sa samostalnom tipkovnicom		382,00
	Dve dodatni mikro šobi Dvije dodatne mikro mlaznice	za masažo stopal (kpl) za masažu stopala (kpl)		61,00
	Servisno prezračevalni pokrov z rešetko Servisno ventilacijski pokrov s rešetkom	za masažne kadi za vgradnjo (45x45 cm) za masažne kade za ugradnju (45x45 cm)	3838987 534808	90,00
	ANTI-SLIP PREMAZ	protizdrsni premaz za kopalne kadi protiv klizni premaz za kupaonske kade (min. kol. 10 kos)		67,00
	Specijalno čištilo KOLPA SAN Specijalno sredstvo za čišćenje	karton 20 kosov / karton 20 komada (Cena za kos / Cijena na komad 6,20 EUR)	3838987 747291	124,00
	Specijalno čištilo ECO SAN Specijalno sredstvo za čišćenje	karton 20 kosov / karton 20 komada (Cena za kos / Cijena na komad 5,40 EUR)	3838987 572220	108,00
	Čistilo za masažne sisteme Sredstvo za čišćenje masažnih sistema	karton 10 kosov / karton 10 komada (Cena za kos / Cijena na komad 7,80 EUR)	3838987 747277	78,00



Kopalne in masažne kadi

Kade za kupanje i masažne kade











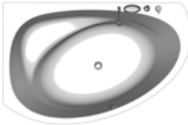

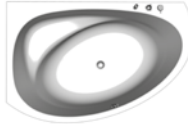

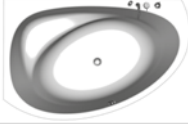

Program:kolpa·san[®]

Model	Naziv in dimenzija izdelka Naziv i dimenzije produkta	Opis Opis	EAN koda EAN koda	Cena EUR Cijena EUR
Libretto-D 160x100				
	Libretto-D 160x100	kopalna kad za vgradnjo kada za ugradnju	3838987 574743	304,00
	Obloga Libretto 160 -D	obloga za kopalno kad - desna obloga za kupaonsku kadu - desna	3838987 565598	174,00
	CKM 120-150	podnožje kopalne kadi za oblogo podnožje kupaonske kade za oblogu	3838987 573043	159,00
	Vodni masažni sistem I. Vodeni masažni sistem I. PNEVMATSKI Libretto-D 160x100	z oblogo s oblogom z oblogo + mikrošobe s oblogom + mikromlaznice	3838987 927402 3838987 927419	1.380,00 1.920,00
	Kombinirani (vodni in zračni) masažni sistem / Kombinirani (vodeni i zračni) masažni sistem ELEKTRONSKI Libretto-D 160x100	z oblogo s oblogom z oblogo + mikrošobe s oblogom + mikromlaznice	3838987 927426 3838987 927433	2.598,00 3.137,00
	Vital masažni sistem Vital masažni sistem ELEKTRONSKI Libretto-D 160x100	z oblogo + mikrošobe s oblogom + mikromlaznice	3838987 927440	4.151,00
Vgradnja mikrošob v kad Ugradnja mikromlaznica u kadu Libretto-D 160x100				
	Prikaz vgradnje mikrošob Prikaz ugradnje mikromlaznica Libretto-D 160x100			

Kopalne in masažne kadi

Kade za kupanje i masažne kade

Program:kolpa·san[®]

Model	Naziv in dimenzija izdelka Naziv i dimenzije produkta	Opis Opis	EAN koda EAN koda	Cena EUR Cijena EUR
Dodatki za / Dodaci za Libretto-D 160x100				
	WATERFALL 	enoročna armatura s tuš ročico in izlivom / jednoručna armatura s tuš ručicom i izljevom	3838987 734543	562,00
	GEYSER 	enoročna arm. s tuš ročico in polnilno /odlivno prelivno gar. za polnjenje kadi jednoručna arm. s tuš ručicom i priljev/odljev prelivnom garnituroz za punjenje kade	3838987 506287	603,00
	RAINDROP 	enoročna armatura s tuš ročico in izlivom / jednoručna armatura s tuš ručicom i izljevom	3838987 726500	590,00
	UP&DOWN, WHITE	prelivna garnitura s sifonom, bela prelivna garnitura sa sifonom, bijela	3838987 922759	62,00
	PAL 650	prelivna garnitura s sifonom prelivna garnitura sa sifonom	3838987 746270	55,00
	HEADREST SOFT	vzglavnik naslon za glavu	3838987 593942	79,00
	HEADREST COAST	vzglavnik naslon za glavu	3838987 593928	103,00
	PKK 501	podnožje kopalne kadi za vgradnjo podnožje kupaonske kade za ugradnju	3838987 764878	28,00
	Zidni montažni set Zidni montažni set	za kopalne in tuš kadi za vgradnjo za kupaonske i tuš kade za ugradnju	3838987 704362	11,00
	Suhomontažna zaključna letva Završna letva u sistemu suhe montaže	karton 25 kosov / karton 25 komada (Cena za kos / Cijena na komad 30,60 EUR)	3838987 903116	765,00
	Chromoterapia (CTL) Chromoterapia (CTL)	2 LED lučki s samostojno tipkovnicu 2 LED svjetla sa samostalnom tipkovnicom		382,00
	Dve dodatni mikro šobi Dvije dodatne mikro mlaznice	za masažo stopal (kpl) za masažu stopala (kpl)		61,00
	Servisno prezračevalni pokrov z rešetko Servisno ventilacijski pokrov s rešetkom	za masažne kadi za vgradnjo (45x45 cm) za masažne kade za ugradnju (45x45 cm)	3838987 534808	90,00
	ANTI-SLIP PREMAZ	protizdrsni premaz za kopalne kadi protiv klizni premaz za kupaonske kade (min. kol. 10 kos)		67,00
	Specialno čištilo KOLPA SAN Specialno sredstvo za čišćenje	karton 20 kosov / karton 20 komada (Cena za kos / Cijena na komad 6,20 EUR)	3838987 747291	124,00
	Specialno čištilo ECO SAN Specialno sredstvo za čišćenje	karton 20 kosov / karton 20 komada (Cena za kos / Cijena na komad 5,40 EUR)	3838987 572220	108,00
	Čištilo za masažne sisteme Sredstvo za čišćenje masažnih sistema	karton 10 kosov / karton 10 komada (Cena za kos / Cijena na komad 7,80 EUR)	3838987 747277	78,00







Kopalne in masažne kadi

Kade za kupanje i masažne kade

Program:

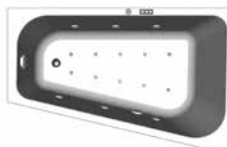









kolpa·san®

Model	Naziv in dimenzija izdelka Naziv i dimenzije produkta	Opis Opis	EAN koda EAN koda	Cena EUR Cijena EUR
Beatrice-L 170x110(70)				
	Beatrice-L 170x110(70)	kopalna kad za vgradnjo kada za ugradnju - leva izvedba - lijeva varijanta	3838987 771043	315,00
	Beatrice-L 170/0	kopalna kad z oblogo kupaonska kada s oblogom - leva izvedba - lijeva varijanta	3838987 771340	716,00
	Vodni masažni sistem I. Vodeni masažni sistem I. PNEVMATSKI Beatrice-L 170x110(70)	z oblogo s oblogom z oblogo + mikrošobe s oblogom + mikromlaznice	3838987 524625 3838987 524656	1.511,00 2.050,00
	Kombinirani (vodni in zračni) masažni sistem / Kombinirani (vodeni i zračni) masažni sistem ELEKTRONSKI Beatrice-L 170x110(70)	z oblogo s oblogom z oblogo + mikrošobe s oblogom + mikromlaznice	3838987 590897 3838987 590903	2.729,00 3.267,00
	Vital masažni sistem Vital masažni sistem ELEKTRONSKI Beatrice-L 170x110(70)	z oblogo + mikrošobe s oblogom + mikromlaznice	3838987 527749	4.269,00
Vgradnja mikrošob v kad Ugradnja mikromlaznica u kadu Beatrice-L 170x110(70)				
	Prikaz vgradnje mikrošob Prikaz ugradnje mikromlaznica Beatrice-L 170x110(70)			

Kopalne in masažne kadi

Kade za kupanje i masažne kade

Program:**kolpa·san**
BY KOLPA

Model	Naziv in dimenzija izdelka Naziv i dimenzije produkta	Opis Opis	EAN koda EAN koda	Cena EUR Cijena EUR
Dodatki za / Dodaci za Beatrice-L 170x110(70)				
	UP&DOWN, WHITE	prelivna garnitura s sifonom, bela prelivna garnitura sa sifonom, bijela	3838987 922759	62,00
	PAL 650	prelivna garnitura s sifonom prelivna garnitura sa sifonom	3838987 746270	55,00
	HEADREST SOFT	vzglavnik naslon za glavu	3838987 593942	79,00
	HEADREST COAST		3838987 593928	103,00
	1001/L	podnožje kopalne kadi za vgradnjo podnožje kupaonske kade za ugradnju	3838987 773375	49,00
	Zidni montažni set Zidni montažni set	za kopalne in tuš kadi za vgradnjo za kupaonske i tuš kade za ugradnju	3838987 704362	11,00
	Suhomontažna zaključna letva Završna letva u sistemu suhe montaže	karton 25 kosov / karton 25 komada (Cena za kos / Cijena na komad 30,60 EUR)	3838987 903116	765,00
	Chromotherapy (CTL) Chromotherapy (CTL)	2 LED lučki s samostojno tipkovnicom 2 LED svjetla sa samostalnom tipkovnicom		382,00
	Dve dodatni mikro šobi Dvije dodatne mikro mlaznice	za masažo stopal (kpl) za masažu stopala (kpl)		61,00
	Servisno prezračevalni pokrov z rešetko Servisno ventilacijski pokrov s rešetkom	za masažne kadi za vgradnjo (45x45 cm) za masažne kade za ugradnju (45x45 cm)	3838987 534808	90,00
	ANTI-SLIP PREMAZ	protizdrsni premaz za kopalne kadi protiv klizni premaz za kupaonske kade (min. kol. 10 kos)		67,00
	Specialno čistilo KOLPA SAN Specialno sredstvo za čišćenje	karton 20 kosov / karton 20 komada (Cena za kos / Cijena na komad 6,20 EUR)	3838987 747291	124,00
	Specialno čistilo ECO SAN Specialno sredstvo za čišćenje	karton 20 kosov / karton 20 komada (Cena za kos / Cijena na komad 5,40 EUR)	3838987 572220	108,00
	Čistilo za masažne sisteme Sredstvo za čišćenje masažnih sistema	karton 10 kosov / karton 10 komada (Cena za kos / Cijena na komad 7,80 EUR)	3838987 747277	78,00





Kopalne in masažne kadi

Kade za kupanje i masažne kade

Program:



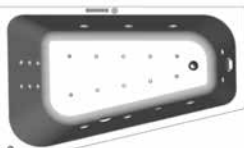







kolpa·san®

Model	Naziv in dimenzija izdelka Naziv i dimenzije produkta	Opis Opis	EAN koda EAN koda	Cena EUR Cijena EUR
Beatrice-D 170x110(70)				
	Beatrice-D 170x110(70)	kopalna kad za vgradnjo kada za ugradnju - desna izvedba - desna varijanta	3838987 771050	315,00
	Beatrice-D 170/0	kopalna kad z oblogo kupaonska kada s oblogom - desna izvedba - desna varijanta	3838987 771364	716,00
	Vodni masažni sistem I. Vodeni masažni sistem I. PNEVMATSKI Beatrice-D 170x110(70)	z oblogo s oblogom z oblogo + mikrošobe s oblogom + mikromlaznice	3838987 524762 3838987 524793	1.511,00 2.050,00
	Kombinirani (vodni in zračni) masažni sistem / Kombinirani (vodni i zračni) masažni sistem ELEKTRONSKI Beatrice-D 170x110(70)	z oblogo s oblogom z oblogo + mikrošobe s oblogom + mikromlaznice	3838987 590934 3838987 590941	2.729,00 3.267,00
	Vital masažni sistem Vital masažni sistem ELEKTRONSKI Beatrice-D 170x110(70)	z oblogo + mikrošobe s oblogom + mikromlaznice	3838987 527732	4.269,00
Vgradnja mikrošob v kad Ugradnja mikromlaznica u kado Beatrice-D 170x110(70)				
	Prikaz vgradnje mikrošob Prikaz ugradnje mikromlaznica Beatrice-D 170x110(70)			

Kopalne in masažne kadi

Kade za kupanje i masažne kade

Program:**kolpa·san**
BY KOLPA





Model	Naziv in dimenzija izdelka Naziv i dimenzije produkta	Opis Opis	EAN koda EAN koda	Cena EUR Cijena EUR
Dodatki za / Dodaci za Beatrice-D 170x110(70)				
	UP&DOWN, WHITE	prelivna garnitura s sifonom, bela prelivna garnitura sa sifonom, bijela	3838987 922759	62,00
	PAL 650	prelivna garnitura s sifonom prelivna garnitura sa sifonom	3838987 746270	55,00
	HEADREST SOFT	vzglavnik naslon za glavu	3838987 593942	79,00
	HEADREST COAST		3838987 593928	103,00
	1001/L	podnožje kopalne kadi za vgradnjo podnožje kupaonske kade za ugradnju	3838987 773375	49,00
	Zidni montažni set Zidni montažni set	za kopalne in tuš kadi za vgradnjo za kupaonske i tuš kade za ugradnju	3838987 704362	11,00
	Suhomontažna zaključna letva Završna letva u sistemu suhe montaže	karton 25 kosov / karton 25 komada (Cena za kos / Cijena na komad 30,60 EUR)	3838987 903116	765,00
	Chromotherapy (CTL) Chromotherapy (CTL)	2 LED lučki s samostojno tipkovnicom 2 LED svjetla sa samostalnom tipkovnicom		382,00
	Dve dodatni mikro šobi Dvije dodatne mikro mlaznice	za masažo stopal (kpl) za masažu stopala (kpl)		61,00
	Servisno prezračevalni pokrov z rešetko Servisno ventilacijski pokrov s rešetkom	za masažne kadi za vgradnjo (45x45 cm) za masažne kade za ugradnju (45x45 cm)	3838987 534808	90,00
	ANTI-SLIP PREMAZ	protizdrsni premaz za kopalne kadi protiv klizni premaz za kupaonske kade (min. kol. 10 kos)		67,00
	Specialno čistilo KOLPA SAN Specialno sredstvo za čišćenje	karton 20 kosov / karton 20 komada (Cena za kos / Cijena na komad 6,20 EUR)	3838987 747291	124,00
	Specialno čistilo ECO SAN Specialno sredstvo za čišćenje	karton 20 kosov / karton 20 komada (Cena za kos / Cijena na komad 5,40 EUR)	3838987 572220	108,00
	Čistilo za masažne sisteme Sredstvo za čišćenje masažnih sistema	karton 10 kosov / karton 10 komada (Cena za kos / Cijena na komad 7,80 EUR)	3838987 747277	78,00



Kopalne in masažne kadi

Kade za kupanje i masažne kade



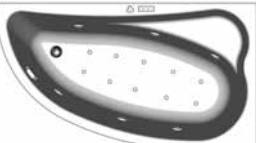







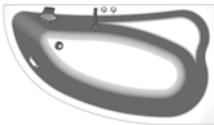

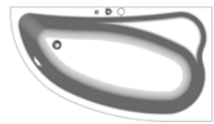



Program:kolpa·san[®]

Model	Naziv in dimenzija izdelka Naziv i dimenzije produkta	Opis Opis	EAN koda EAN koda	Cena EUR Cijena EUR
Calando-L 160x90				
	Calando-L 160x90	kopalna kad za vgradnjo kada za ugradnju	3838987 570783	260,00
	Obloga Calando 160	obloga za kopalno kad obloga za kupaonsku kado	3838987 539681	122,00
	CAM 150-180	podnožje kopalne kadi za oblogo podnožje kupaonske kade za oblogo	3838987 573029	133,00
	Vodni masažni sistem I. Vodeni masažni sistem I. PNEVMATSKI Calando-L 160x90	z oblogo s oblogom	3838987 571933	1.342,00
	Kombinirani (vodni in zračni) masažni sistem / Kombinirani (vodeni i zračni) masažni sistem ELEKTRONSKI Calando-L 160x90	z oblogo s oblogom	3838987 590972	2.557,00

Kopalne in masažne kadi

Kade za kupanje i masažne kade

Program:kolpa·san[®]

Model	Naziv in dimenzija izdelka Naziv i dimenzije produkta	Opis Opis	EAN koda EAN koda	Cena EUR Cijena EUR
Dodatki za / Dodaci za Calando-L 160x90				
	WATERFALL 	enoročna armatura s tuš ročico in izlivom / jednoručna armatura s tuš ručicom i izljevom	3838987 734543	562,00
	GEYSER 	enoročna arm. s tuš ročico in polnilno /odlivno prelivno gar. za polnjenje kadi jednoručna arm. s tuš ručicom i priljev/odljev prelivnom garnituroom za punjenje kada	3838987 506287	603,00
	RAINDROP 	enoročna armatura s tuš ročico in izlivom / jednoručna armatura s tuš ručicom i izljevom	3838987 726500	590,00
	UP&DOWN, WHITE	prelivna garnitura s sifonom, bela prelivna garnitura sa sifonom, bijela	3838987 922759	62,00
	PAL 450	prelivna garnitura s sifonom prelivna garnitura sa sifonom	3838987 746263	40,00
	HEADREST SOFT	vzglavnik naslon za glavu	3838987 593942	79,00
	HEADREST COAST		3838987 593928	103,00
	PKK 501	podnožje kopalne kadi za vgradnjo podnožje kupaonske kade za ugradnju	3838987 764878	28,00
	TP 104/K UNI SOLE Silver	dvodelni krilni zaslon za kop. kad CALANDO, h=140 dvodijelni krilni zaslon za kup. kadu CALANDO, h=140	3838987 514817	301,00
	TP 108 QUAT Bela		3838987 726753	157,00
	Zidni montažni set Zidni montažni set	za kopalne in tuš kadi za vgradnjo za kupaonske i tuš kade za ugradnju	3838987 704362	11,00
	Suhomontažna zaključna letva Završna letva u sistemu suhe montaže	karton 25 kosov / karton 25 komada (Cena za kos / Cijena na komad 30,60 EUR)	3838987 903116	765,00
	Chromoterapia (CTL) Chromoterapia (CTL)	2 LED lučki s samostalno tipkovnico 2 LED svjetla sa samostalnom tipkovnicom		382,00
	Servisno prezračevalni pokrov z rešetko Servisno ventilacijski pokrov s rešetkom	za masažne kadi za vgradnjo (45x45 cm) za masažne kade za ugradnju (45x45 cm)	3838987 534808	90,00
	ANTI-SLIP PREMAZ	protizdrski premaz za kopalne kadi protiv klizni premaz za kupaonske kade (min. kol. 10 kos)		67,00
	Specialno čištilo KOLPA SAN Specialno sredstvo za čišćenje	karton 20 kosov / karton 20 komada (Cena za kos / Cijena na komad 6,20 EUR)	3838987 747291	124,00
	Specialno čištilo ECO SAN Specialno sredstvo za čišćenje	karton 20 kosov / karton 20 komada (Cena za kos / Cijena na komad 5,40 EUR)	3838987 572220	108,00
	Čištilo za masažne sisteme Sredstvo za čišćenje masažnih sistema	karton 10 kosov / karton 10 komada (Cena za kos / Cijena na komad 7,80 EUR)	3838987 747277	78,00



Kopalne in masažne kadi

Kade za kupanje i masažne kade

Program:kolpa·san[®]

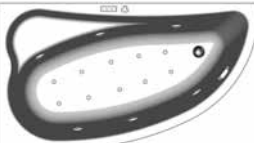









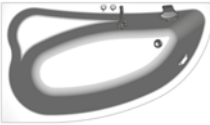

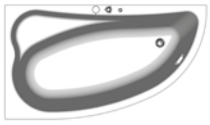

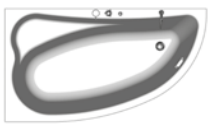
Model	Naziv in dimenzija izdelka Naziv i dimenzije produkta	Opis Opis	EAN koda EAN koda	Cena EUR Cijena EUR
Calando-D 160x90				
	Calando-D 160x90	kopalna kad za vgradnjo kada za ugradnju	3838987 570769	260,00
	Obloga Calando 160	obloga za kopalno kad obloga za kupaonsku kado	3838987 539681	122,00
	CAM 150-180	podnožje kopalne kadi za oblogo podnožje kupaonske kade za oblogo	3838987 573029	133,00
	Vodni masažni sistem I. Vodeni masažni sistem I. PNEVMATSKI Calando-D 160x90	z oblogo s oblogom	3838987 527763	1.342,00
	Kombinirani (vodni in zračni) masažni sistem / Kombinirani (vodeni i zračni) masažni sistem ELEKTRONSKI Calando-D 160x90	z oblogo s oblogom	3838987 591016	2.557,00

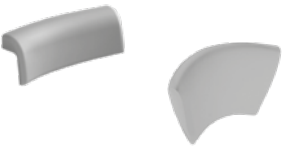
Kopalne in masažne kadi

Kade za kupanje i masažne kade

Program:

kolpa·san
BY KOLPA





Model	Naziv in dimenzija izdelka Naziv i dimenzije produkta	Opis Opis	EAN koda EAN koda	Cena EUR Cijena EUR
Dodatki za / Dodaci za Calando-D 160x90				
	WATERFALL 	enoročna armatura s tuš ročico in izlivom / jednoručna armatura s tuš ručicom i izljevom	3838987 734543	562,00
	GEYSER 	enoročna arm. s tuš ročico in polnilno /odlivno prelivno gar. za polnjenje kadi jednoručna arm. s tuš ručicom i priljev/odljev prelivnom garnituroom za punjenje kada	3838987 506287	603,00
	RAINDROP 	enoročna armatura s tuš ročico in izlivom / jednoručna armatura s tuš ručicom i izljevom	3838987 726500	590,00
	UP&DOWN, WHITE	prelivna garnitura s sifonom, bela prelivna garnitura sa sifonom, bijela	3838987 922759	62,00
	PAL 450	prelivna garnitura s sifonom prelivna garnitura sa sifonom	3838987 746263	40,00
	HEADREST SOFT	vzglavnik naslon za glavu	3838987 593942	79,00
	HEADREST COAST		3838987 593928	103,00
	PKK 501	podnožje kopalne kadi za vgradnjo podnožje kupaonske kade za ugradnju	3838987 764878	28,00
	TP 104/K UNI SOLE Silver	dvodelni krilni zaslon za kop. kad CALANDO, h=140	3838987 514817	301,00
	TP 108 QUAT Bela	dvodijelni krilni zaslon za kup. kadu CALANDO, h=140	3838987 726753	157,00
	Zidni montažni set Zidni montažni set	za kopalne in tuš kadi za vgradnjo za kupaonske i tuš kade za ugradnju	3838987 704362	11,00
	Suhomontažna zaključna letva Završna letva u sistemu suhe montaže	karton 25 kosov / karton 25 komada (Cena za kos / Cijena na komad 30,60 EUR)	3838987 903116	765,00
	Chromoterapia (CTL) Chromoterapia (CTL)	2 LED lučki s samostojno tipkovnicom 2 LED svjetla sa samostalnom tipkovnicom		382,00
	Servisno prezračevalni pokrov z rešetko Servisno ventilacijski pokrov s rešetkom	za masažne kadi za vgradnjo (45x45 cm) za masažne kade za ugradnju (45x45 cm)	3838987 534808	90,00
	ANTI-SLIP PREMAZ	protizdrsni premaz za kopalne kadi protiv klizni premaz za kupaonske kade (min. kol. 10 kos)		67,00
	Specialno čištilo KOLPA SAN Specialno sredstvo za čišćenje	karton 20 kosov / karton 20 komada (Cena za kos / Cijena na komad 6,20 EUR)	3838987 747291	124,00
	Specialno čištilo ECO SAN Specialno sredstvo za čišćenje	karton 20 kosov / karton 20 komada (Cena za kos / Cijena na komad 5,40 EUR)	3838987 572220	108,00
	Čištilo za masažne sisteme Sredstvo za čišćenje masažnih sistema	karton 10 kosov / karton 10 komada (Cena za kos / Cijena na komad 7,80 EUR)	3838987 747277	78,00



Kopalne in masažne kadi

Kade za kupanje i masažne kade



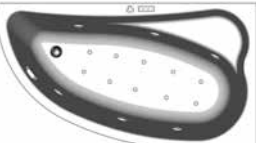







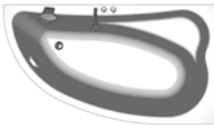

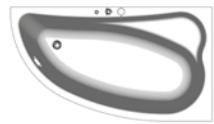



Program:kolpa·san[®]

Model	Naziv in dimenzija izdelka Naziv i dimenzije produkta	Opis Opis	EAN koda EAN koda	Cena EUR Cijena EUR
Calando-L 150x85				
	Calando-L 150x85	kopalna kad za vgradnjo kada za ugradnju	3838987 592983	244,00
	Obloga Calando 150	obloga za kopalno kad obloga za kupaonsku kado	3838987 563198	122,00
	CAM 150-180	podnožje kopalne kadi za oblogo podnožje kupaonske kade za oblogo	3838987 573029	133,00
	Vodni masažni sistem I. Vodeni masažni sistem I. PNEVMATSKI Calando-L 150x85	z oblogo s oblogom	3838987 576884	1.326,00
	Kombinirani (vodni in zračni) masažni sistem / Kombinirani (vodeni i zračni) masažni sistem ELEKTRONSKI Calando-L 150x85	z oblogo s oblogom	3838987 576907	2.543,00

Kopalne in masažne kadi
Kade za kupanje i masažne kade

Program:

kolpa·san
BY KOLPA

Model	Naziv in dimenzija izdelka Naziv i dimenzije produkta	Opis Opis	EAN koda EAN koda	Cena EUR Cijena EUR
Dodatki za / Dodaci za Calando-L 150x85				
	WATERFALL 	enoročna armatura s tuš ročico in izlivom / jednoručna armatura s tuš ručicom i izljevom	3838987 734543	562,00
	GEYSER 	enoročna arm. s tuš ročico in polnilno /odlivno prelivno gar. za polnjenje kadi jednoručna arm. s tuš ručicom i priljev/odljev preljevnom garnituroom za punjenje kada	3838987 506287	603,00
	RAINDROP 	enoročna armatura s tuš ročico in izlivom / jednoručna armatura s tuš ručicom i izljevom	3838987 726500	590,00
	UP&DOWN, WHITE	prelivna garnitura s sifonom, bela preljevna garnitura sa sifonom, bijela	3838987 922759	62,00
	PAL 450	prelivna garnitura s sifonom preljevna garnitura sa sifonom	3838987 746263	40,00
	HEADREST SOFT	vzglavnik naslon za glavu	3838987 593942	79,00
	HEADREST COAST		3838987 593928	103,00
	PKK 501	podnožje kopalne kadi za vgradnjo podnožje kupaonske kade za ugradnju	3838987 764878	28,00
	TP 104/K UNI SOLE Silver	dvodelni krilni zaslon za kop. kad CALANDO, h=140	3838987 514817	301,00
	TP 108 QUAT Bela	dvodijelni krilni zaslon za kup. kadu CALANDO, h=140	3838987 726753	157,00
	Zidni montažni set Zidni montažni set	za kopalne in tuš kadi za vgradnjo za kupaonske i tuš kade za ugradnju	3838987 704362	11,00
	Suhomontažna zaključna letva Završna letva u sistemu suhe montaže	karton 25 kosov / karton 25 komada (Cena za kos / Cijena na komad 30,60 EUR)	3838987 903116	765,00
	Chromotherapia (CTL) Chromotherapia (CTL)	2 LED lučki s samostojno tipkovnicom 2 LED svjetla sa samostalnom tipkovnicom		382,00
	Servisno prezračevalni pokrov z rešetko Servisno ventilacijski pokrov s rešetkom	za masažne kadi za vgradnjo (45x45 cm) za masažne kade za ugradnju (45x45 cm)	3838987 534808	90,00
	ANTI-SLIP PREMAZ	protizdrsni premaz za kopalne kadi protiv klizni premaz za kupaonske kade (min. kol. 10 kos)		67,00
	Specialno čištilo KOLPA SAN Specialno sredstvo za čišćenje	karton 20 kosov / karton 20 komada (Cena za kos / Cijena na komad 6,20 EUR)	3838987 747291	124,00
	Specialno čištilo ECO SAN Specialno sredstvo za čišćenje	karton 20 kosov / karton 20 komada (Cena za kos / Cijena na komad 5,40 EUR)	3838987 572220	108,00
	Čištilo za masažne sisteme Sredstvo za čišćenje masažnih sistema	karton 10 kosov / karton 10 komada (Cena za kos / Cijena na komad 7,80 EUR)	3838987 747277	78,00



Kopalne in masažne kadi

Kade za kupanje i masažne kade

Program:kolpa·san[®]

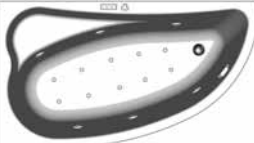









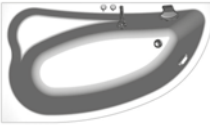

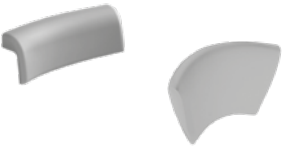

Model	Naziv in dimenzija izdelka Naziv i dimenzije produkta	Opis Opis	EAN koda EAN koda	Cena EUR Cijena EUR
Calando-D 150x85				
	Calando-D 150x85	kopalna kad za vgradnjo kada za ugradnju	3838987 592976	244,00
	Obloga Calando 150	obloga za kopalno kad obloga za kupaonsku kado	3838987 563198	122,00
	CAM 150-180	podnožje kopalne kadi za oblogo podnožje kupaonske kade za oblogo	3838987 573029	133,00
	Vodni masažni sistem I. Vodeni masažni sistem I. PNEVMATSKI Calando-D 150x85	z oblogo s oblogom	3838987 576808	1.326,00
	Kombinirani (vodni in zračni) masažni sistem / Kombinirani (vodeni i zračni) masažni sistem ELEKTRONSKI Calando-D 150x85	z oblogo s oblogom	3838987 576822	2.543,00

Kopalne in masažne kadi

Kade za kupanje i masažne kade

Program:

kolpa·san
BY KOLPA









Model	Naziv in dimenzija izdelka Naziv i dimenzije produkta	Opis Opis	EAN koda EAN koda	Cena EUR Cijena EUR
Dodatki za / Dodaci za Calando-D 150x85				
	WATERFALL 	enoročna armatura s tuš ročico in izlivom / jednoručna armatura s tuš ručicom i izljevom	3838987 734543	562,00
	GEYSER 	enoročna arm. s tuš ročico in polnilno /odlivno prelivno gar. za polnjenje kadi jednoručna arm. s tuš ručicom i priljev/odljev prelivnom garnituroom za punjenje kada	3838987 506287	603,00
	RAINDROP 	enoročna armatura s tuš ročico in izlivom / jednoručna armatura s tuš ručicom i izljevom	3838987 726500	590,00
	UP&DOWN, WHITE	prelivna garnitura s sifonom, bela prelivna garnitura sa sifonom, bijela	3838987 922759	62,00
	PAL 450	prelivna garnitura s sifonom prelivna garnitura sa sifonom	3838987 746263	40,00
	HEADREST SOFT	vzglavnik naslon za glavu	3838987 593942	79,00
	HEADREST COAST		3838987 593928	103,00
	PKK 501	podnožje kopalne kadi za vgradnjo podnožje kupaonske kade za ugradnju	3838987 764878	28,00
	TP 104/K UNI SOLE Silver	dvodelni krilni zaslon za kop. kad CALANDO, h=140	3838987 514817	301,00
	TP 108 QUAT Bela	dvodijelni krilni zaslon za kup. kadu CALANDO, h=140	3838987 726753	157,00
	Zidni montažni set Zidni montažni set	za kopalne in tuš kadi za vgradnjo za kupaonske i tuš kade za ugradnju	3838987 704362	11,00
	Suhomontažna zaključna letva Završna letva u sistemu suhe montaže	karton 25 kosov / karton 25 komada (Cena za kos / Cijena na komad 30,60 EUR)	3838987 903116	765,00
	Chromotherapia (CTL) Chromotherapia (CTL)	2 LED lučki s samostojno tipkovnicom 2 LED svjetla sa samostalnom tipkovnicom		382,00
	Servisno prezračevalni pokrov z rešetko Servisno ventilacijski pokrov s rešetkom	za masažne kadi za vgradnjo (45x45 cm) za masažne kade za ugradnju (45x45 cm)	3838987 534808	90,00
	ANTI-SLIP PREMAZ	protizdrsni premaz za kopalne kadi protiv klizni premaz za kupaonske kade (min. kol. 10 kos)		67,00
	Specialno čištilo KOLPA SAN Specialno sredstvo za čišćenje	karton 20 kosov / karton 20 komada (Cena za kos / Cijena na komad 6,20 EUR)	3838987 747291	124,00
	Specialno čištilo ECO SAN Specialno sredstvo za čišćenje	karton 20 kosov / karton 20 komada (Cena za kos / Cijena na komad 5,40 EUR)	3838987 572220	108,00
	Čištilo za masažne sisteme Sredstvo za čišćenje masažnih sistema	karton 10 kosov / karton 10 komada (Cena za kos / Cijena na komad 7,80 EUR)	3838987 747277	78,00

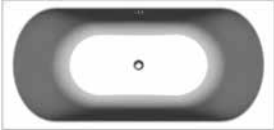

Kopalne in masažne kadi
Kade za kupanje i masažne kade

Program:

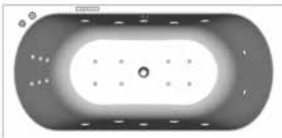
kolpa·san
BY KOLPA













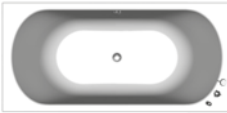
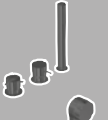

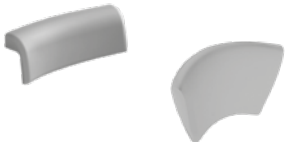

Model	Naziv in dimenzija izdelka Naziv i dimenzije produkta	Opis Opis	EAN koda EAN koda	Cena EUR Cijena EUR
Betty 200x90				
	Betty 200x90	kopalna kad za vgradnjo kada za ugradnju	3838987 565406	445,00
	A 200/63	dolga obloga duga obloga	3838987 565420	87,00
	A 90/63	kratka obloga kratka obloga	3838987 565413	55,00
	CM 180-200	podnožje kopalne kadi za oblogo podnožje kupaonske kade za oblogu	3838987 573012	119,00
	Vodni masažni sistem I. Vodeni masažni sistem I. PNEVMATSKI Betty 200x90	z oblogo s oblogom z oblogo + mikrošobe s oblogom + mikromlaznice	3838987 513650 3838987 513667	1.464,00 2.003,00
	Kombinirani (vodni in zračni) masažni sistem / Kombinirani (vodeni i zračni) masažni sistem ELEKTRONSKI Betty 200x90	z oblogo s oblogom z oblogo + mikrošobe s oblogom + mikromlaznice	3838987 513674 3838987 513681	2.651,00 3.191,00
	Vital masažni sistem Vital masažni sistem ELEKTRONSKI Betty 200x90	z oblogo + mikrošobe s oblogom + mikromlaznice	3838987 513698	4.149,00
Vgradnja mikrošob v kad Ugradnja mikromlaznica u kadu Betty 200x90				
	Prikaz vgradnje mikrošob Prikaz ugradnje mikromlaznica Betty 200x90			

Kopalne in masažne kadi

Kade za kupanje i masažne kade

Program:

kolpa·san
BY KOLPA









Model	Naziv in dimenzija izdelka Naziv i dimenzije produkta	Opis Opis	EAN koda EAN koda	Cena EUR Cijena EUR
Dodatki za / Dodaci za Betty 200x90				
	WATERFALL 	enoročna armatura s tuš ročico in izlivom / jednoručna armatura s tuš ručicom i izljevom	3838987 734543	562,00
	GEYSER 	enoročna arm. s tuš ročico in polnilno /odlivno prelivno gar. za polnjenje kadi jednoručna arm. s tuš ručicom i priljev/odljev prelivnom garniturom za punjenje kade	3838987 506287	603,00
	RAINDROP 	enoročna armatura s tuš ročico in izlivom / jednoručna armatura s tuš ručicom i izljevom	3838987 726500	590,00
	UP&DOWN, WHITE	prelivna garnitura s sifonom, bela prelivna garnitura sa sifonom, bijela	3838987 922759	62,00
	PAL 650	prelivna garnitura s sifonom prelivna garnitura sa sifonom	3838987 746270	55,00
	HEADREST SOFT	vzglavnik naslon za glavu	3838987 593942	79,00
	HEADREST COAST	vzglavnik naslon za glavu	3838987 593928	103,00
	PKK 501	podnožje kopalne kadi za vgradnjo podnožje kupaonske kade za ugradnju	3838987 764878	28,00
	Zidni montažni set Zidni montažni set	za kopalne in tuš kadi za vgradnjo za kupaonske i tuš kade za ugradnju	3838987 704362	11,00
	Montažni set za oblogo /magnet Montažni set za oblogu / magnet	za kopalne kadi (v primeru dodatne kratke obloge) / za kupaonske kade (u primeru dodatne kratke obloge)	3838987 590750	28,00
	Suhomontažna zaključna letva Završna letva u sistemu suhe montaže	karton 25 kosov / karton 25 komada (Cena za kos / Cijena na komad 30,60 EUR)	3838987 903116	765,00
	Chromoterapia (CTL) Chromoterapia (CTL)	2 LED lučki s samostojno tipkovnicom 2 LED svjetla sa samostalnom tipkovnicom		382,00
	Dve dodatni mikro šobi Dvije dodatne mikro mlaznice	za masažo stopal (kpl) za masažu stopala (kpl)		61,00
	Servisno prezračevalni pokrov z rešetkom Servisno ventilacijski pokrov s rešetkom	za masažne kadi za vgradnjo (45x45 cm) za masažne kade za ugradnju (45x45 cm)	3838987 534808	90,00
	ANTI-SLIP PREMAZ	protizdrsni premaz za kopalne kadi protiv klizni premaz za kupaonske kade (min. kol. 10 kos)		67,00
	Specialno čištilo KOLPA SAN Specialno sredstvo za čišćenje	karton 20 kosov / karton 20 komada (Cena za kos / Cijena na komad 6,20 EUR)	3838987 747291	124,00
	Specialno čištilo ECO SAN Specialno sredstvo za čišćenje	karton 20 kosov / karton 20 komada (Cena za kos / Cijena na komad 5,40 EUR)	3838987 572220	108,00
	Čištilo za masažne sisteme Sredstvo za čišćenje masažnih sistema	karton 10 kosov / karton 10 komada (Cena za kos / Cijena na komad 7,80 EUR)	3838987 747277	78,00

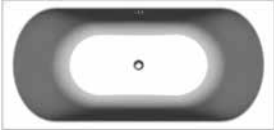

Kopalne in masažne kadi

Kade za kupanje i masažne kade

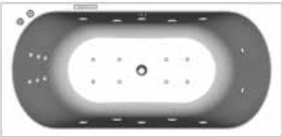
Program:**kolpa·san**
BY KOLPA













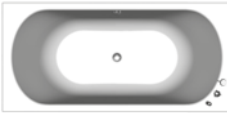
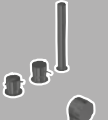

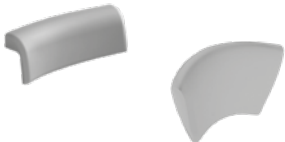

Model	Naziv in dimenzija izdelka Naziv i dimenzije produkta	Opis Opis	EAN koda EAN koda	Cena EUR Cijena EUR
Betty 190x90				
	Betty 190x90	kopalna kad za vgradnjo kada za ugradnju	3838987 565451	377,00
	A 190/63	dolga obloga duga obloga	3838987 565468	87,00
	A 90/63	kratka obloga kratka obloga	3838987 565413	55,00
	CM 180-200	podnožje kopalne kadi za oblogo podnožje kupaonske kade za oblogu	3838987 573012	119,00
	Vodni masažni sistem I. Vodeni masažni sistem I. PNEVMATSKI Betty 190x90	z oblogo s oblogom z oblogo + mikrošobe s oblogom + mikromlaznice	3838987 513704 3838987 513711	1.402,00 1.941,00
	Kombinirani (vodni in zračni) masažni sistem / Kombinirani (vodeni i zračni) masažni sistem ELEKTRONSKI Betty 190x90	z oblogo s oblogom z oblogo + mikrošobe s oblogom + mikromlaznice	3838987 513728 3838987 513735	2.589,00 3.129,00
	Vital masažni sistem Vital masažni sistem ELEKTRONSKI Betty 190x90	z oblogo + mikrošobe s oblogom + mikromlaznice	3838987 513742	4.087,00
Vgradnja mikrošob v kad Ugradnja mikromlaznica u kadu Betty 190x90				
	Prikaz vgradnje mikrošob Prikaz ugradnje mikromlaznica Betty 190x90			

Kopalne in masažne kadi

Kade za kupanje i masažne kade

Program:

kolpa·san
BY KOLPA

Model	Naziv in dimenzija izdelka Naziv i dimenzije produkta	Opis Opis	EAN koda EAN koda	Cena EUR Cijena EUR
Dodatki za / Dodaci za Betty 190x90				
	WATERFALL 	enoročna armatura s tuš ročico in izlivom / jednoručna armatura s tuš ručicom i izljevom	3838987 734543	562,00
	GEYSER 	enoročna arm. s tuš ročico in polnilno /odlivno prelivno gar. za polnjenje kadi jednoručna arm. s tuš ručicom i priljev/odljev prelivnom garniturom za punjenje kade	3838987 506287	603,00
	RAINDROP 	enoročna armatura s tuš ročico in izlivom / jednoručna armatura s tuš ručicom i izljevom	3838987 726500	590,00
	UP&DOWN, WHITE	prelivna garnitura s sifonom, bela prelivna garnitura sa sifonom, bijela	3838987 922759	62,00
	PAL 650	prelivna garnitura s sifonom prelivna garnitura sa sifonom	3838987 746270	55,00
	HEADREST SOFT	vzglavnik naslon za glavu	3838987 593942	79,00
	HEADREST COAST	vzglavnik naslon za glavu	3838987 593928	103,00
	PKK 501	podnožje kopalne kadi za vgradnjo podnožje kupaonske kade za ugradnju	3838987 764878	28,00
	Zidni montažni set Zidni montažni set	za kopalne in tuš kadi za vgradnjo za kupaonske i tuš kade za ugradnju	3838987 704362	11,00
	Montažni set za oblogo /magnet Montažni set za oblogu / magnet	za kopalne kadi (v primeru dodatne kratke obloge) / za kupaonske kade (u primeru dodatne kratke obloge)	3838987 590750	28,00
	Suhomontažna zaključna letev Završna letva u sistemu suhe montaže	karton 25 kosov / karton 25 komada (Cena za kos / Cijena na komad 30,60 EUR)	3838987 903116	765,00
	Chromoterapia (CTL) Chromoterapia (CTL)	2 LED lučki s samostojno tipkovnico 2 LED svjetla sa samostalnom tipkovnicom		382,00
	Dve dodatni mikro šobi Dvije dodatne mikro mlaznice	za masažo stopal (kpl) za masažu stopala (kpl)		61,00
	Servisno prezračevalni pokrov z rešetko Servisno ventilacijski pokrov s rešetkom	za masažne kadi za vgradnjo (45x45 cm) za masažne kade za ugradnju (45x45 cm)	3838987 534808	90,00
	ANTI-SLIP PREMAZ	protizdrsni premaz za kopalne kadi protiv klizni premaz za kupaonske kade (min. kol. 10 kos)		67,00
	Specialno čistilo KOLPA SAN Specialno sredstvo za čišćenje	karton 20 kosov / karton 20 komada (Cena za kos / Cijena na komad 6,20 EUR)	3838987 747291	124,00
	Specialno čistilo ECO SAN Specialno sredstvo za čišćenje	karton 20 kosov / karton 20 komada (Cena za kos / Cijena na komad 5,40 EUR)	3838987 572220	108,00
	Čistilo za masažne sisteme Sredstvo za čišćenje masažnih sistema	karton 10 kosov / karton 10 komada (Cena za kos / Cijena na komad 7,80 EUR)	3838987 747277	78,00











Kopalne in masažne kadi

Kade za kupanje i masažne kade

Program:

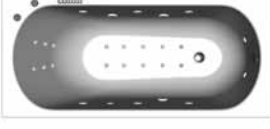
kolpa·san®















Model	Naziv in dimenzija izdelka Naziv i dimenzije produkta	Opis Opis	EAN koda EAN koda	Cena EUR Cijena EUR
Betty 180x80				
	Betty 180x80	kopalna kad za vgradnjo kada za ugradnjo	3838987 565192	292,00
	A 180/63	dolga obloga duga obloga	3838987 565215	73,00
	A 80/63	kratka obloga kratka obloga	3838987 565222	49,00
	CM 180-200	podnožje kopalne kadi za oblogo podnožje kupaonske kade za oblogu	3838987 573012	119,00
	Betty E2 180x80	kopalna kad za vgradnjo kada za ugradnjo višina roba kadi = 20 mm visina ruba kade = 20 mm * Ni možnosti v kombinaciji z oblogo, niti z masažnim sistemom	3838987 705338	321,00
	Vodni masažni sistem I. Vodeni masažni sistem I. PNEVMATSKI Betty 180x80	z oblogo s oblogom	3838987 513803	1.325,00
		z oblogo + mikrošobe s oblogom + mikromlaznice	3838987 513810	1.864,00
	Kombinirani (vodni in zračni) masažni sistem / Kombinirani (vodeni i zračni) masažni sistem ELEKTRONSKI Betty 180x80	z oblogo s oblogom	3838987 513827	2.512,00
		z oblogo + mikrošobe s oblogom + mikromlaznice	3838987 513834	3.052,00
	Vital masažni sistem Vital masažni sistem ELEKTRONSKI Betty 180x80	z oblogo + mikrošobe s oblogom + mikromlaznice	3838987 513841	4.010,00
Vgradnja mikrošob v kad Ugradnja mikromlaznica u kadu Betty 180x80				
	Prikaz vgradnje mikrošob Prikaz ugradnje mikromlaznica Betty 180x80			

Kopalne in masažne kadi

Kade za kupanje i masažne kade

Program:

kolpa·san
BY KOLPA







Model	Naziv in dimenzija izdelka Naziv i dimenzije produkta	Opis Opis	EAN koda EAN koda	Cena EUR Cijena EUR
Dodatki za / Dodaci za Betty 180x80				
	GEYSER 	enoročna arm. s tuš ročico in polnilno /odlivno prelivno gar. za polnjenje kadi jednoročna arm. s tuš ručicom i priljev/odljev prelivnom garniturom za punjenje kada	3838987 506287	603,00
	RAINDROP 	enoročna armatura s tuš ročico in izlivom / jednoročna armatura s tuš ručicom i izljevom	3838987 726500	590,00
	UP&DOWN, WHITE	prelivna garnitura s sifonom, bela prelivna garnitura sa sifonom, bijela	3838987 922759	62,00
	PAL 650	prelivna garnitura s sifonom prelivna garnitura sa sifonom	3838987 746270	55,00
	HEADREST SOFT	vzglavnik naslon za glavu	3838987 593942	79,00
	HEADREST COAST	vzglavnik naslon za glavu	3838987 593928	103,00
	PKK 501	podnožje kopalne kadi za vgradnjo podnožje kupaonske kade za ugradnju	3838987 764878	28,00
	Zidni montažni set Zidni montažni set	za kopalne in tuš kadi za vgradnjo za kupaonske i tuš kade za ugradnju	3838987 704362	11,00
	Montažni set za oblogo /magnet Montažni set za oblogu / magnet	za kopalne kadi (v primeru dodatne kratke obloge) / za kupaonske kade (u primeru dodatne kratke obloge)	3838987 590750	28,00
	Suhomontažna zaključna letev Završna letva u sistemu suhe montaže	karton 25 kosov / karton 25 komada (Cena za kos / Cijena na komad 30,60 EUR)	3838987 903116	765,00
	Chromotherapie (CTL) Chromotherapie (CTL)	2 LED lučki s samostojno tipkovnico 2 LED svjetla sa samostalnom tipkovnicom		382,00
	Dve dodatni mikro šobi Dvije dodatne mikro mlaznice	za masažo stopal (kpl) za masažu stopala (kpl)		61,00
	Servisno prezračevalni pokrov z rešetko Servisno ventilacijski pokrov s rešetkom	za masažne kadi za vgradnjo (45x45 cm) za masažne kade za ugradnju (45x45 cm)	3838987 534808	90,00
	ANTI-SLIP PREMAZ	protizdrsni premaz za kopalne kadi protiv klizni premaz za kupaonske kade (min. kol. 10 kos)		67,00
	Specialno čistilo KOLPA SAN Specialno sredstvo za čišćenje	karton 20 kosov / karton 20 komada (Cena za kos / Cijena na komad 6,20 EUR)	3838987 747291	124,00
	Specialno čistilo ECO SAN Specialno sredstvo za čišćenje	karton 20 kosov / karton 20 komada (Cena za kos / Cijena na komad 5,40 EUR)	3838987 572220	108,00
	Čistilo za masažne sisteme Sredstvo za čišćenje masažnih sistema	karton 10 kosov / karton 10 komada (Cena za kos / Cijena na komad 7,80 EUR)	3838987 747277	78,00

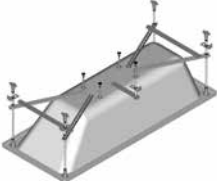

Kopalne in masažne kadi

Kade za kupanje i masažne kade

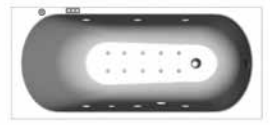
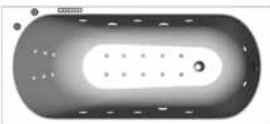













Program:kolpa·san[®]

Model	Naziv in dimenzija izdelka Naziv i dimenzije produkta	Opis Opis	EAN koda EAN koda	Cena EUR Cijena EUR
Betty 170x80				
	Betty 170x80	kopalna kad za vgradnjo kada za ugradnjo	3838987 565925	278,00
	A 170/63	dolga obloga duga obloga	3838987 565376	73,00
	A 80/63	kratka obloga kratka obloga	3838987 565222	49,00
	CM 160-170	podnožje kopalne kadi za oblogo podnožje kupaonske kade za oblogu	3838987 573005	119,00
	Betty E2 170x80	kopalna kad za vgradnjo kada za ugradnjo višina roba kadi = 20 mm visina ruba kade = 20 mm * Ni možnosti v kombinaciji z oblogo, niti z masažnim sistemom	3838987 705321	306,00
	Vodni masažni sistem I. Vodeni masažni sistem I. PNEVMATSKI Betty 170x80	z oblogo s oblogom	3838987 513759	1.312,00
		z oblogo + mikrošobe s oblogom + mikromlaznice	3838987 513766	1.851,00
	Kombinirani (vodni in zračni) masažni sistem / Kombinirani (vodni i zračni) masažni sistem ELEKTRONSKI Betty 170x80	z oblogo s oblogom	3838987 513773	2.500,00
		z oblogo + mikrošobe s oblogom + mikromlaznice	3838987 513780	3.039,00
	Vital masažni sistem Vital masažni sistem ELEKTRONSKI Betty 170x80	z oblogo + mikrošobe s oblogom + mikromlaznice	3838987 513797	3.998,00
Vgradnja mikrošob v kad Ugradnja mikromlaznica u kado Betty 170x80				
	Prikaz vgradnje mikrošob Prikaz ugradnje mikromlaznica Betty 170x80			

Kopalne in masažne kadi

Kade za kupanje i masažne kade

Program:kolpa·san[®]









Model	Naziv in dimenzija izdelka Naziv i dimenzije produkta	Opis Opis	EAN koda EAN koda	Cena EUR Cijena EUR
Dodatki za / Dodaci za Betty 170x80				
	GEYSER 	enoročna arm. s tuš ročico in polnilno /odlivno prelivno gar. za polnjenje kadi jednoročna arm. s tuš ručicom i priljev/odljev prelivnom garnituroom za punjenje kada	3838987 506287	603,00
	RAINDROP 	enoročna armatura s tuš ročico in izlivom / jednoročna armatura s tuš ručicom i izljevom	3838987 726500	590,00
	UP&DOWN, WHITE	prelivna garnitura s sifonom, bela prelivna garnitura sa sifonom, bijela	3838987 922759	62,00
	PAL 650	prelivna garnitura s sifonom prelivna garnitura sa sifonom	3838987 746270	55,00
	HEADREST SOFT	vzglavnik naslon za glavu	3838987 593942	79,00
	HEADREST COAST	vzglavnik naslon za glavu	3838987 593928	103,00
	PKK 501	podnožje kopalne kadi za vgradnjo podnožje kupaonske kade za ugradnju	3838987 764878	28,00
	Zidni montažni set Zidni montažni set	za kopalne in tuš kadi za vgradnjo za kupaonske i tuš kade za ugradnju	3838987 704362	11,00
	Montažni set za oblogo /magnet Montažni set za oblogu / magnet	za kopalne kadi (v primeru dodatne kratke obloge) / za kupaonske kade (u primeru dodatne kratke obloge)	3838987 590750	28,00
	Suhomontažna zaključna letev Završna letva u sistemu suhe montaže	karton 25 kosov / karton 25 komada (Cena za kos / Cijena na komad 30,60 EUR)	3838987 903116	765,00
	Chromotherapie (CTL) Chromotherapie (CTL)	2 LED lučki s samostojno tipkovnico 2 LED svjetla sa samostalnom tipkovnicom		382,00
	Dve dodatni mikro šobi Dvije dodatne mikro mlaznice	za masažo stopal (kpl) za masažu stopala (kpl)		61,00
	Servisno prezračevalni pokrov z rešetko Servisno ventilacijski pokrov s rešetkom	za masažne kadi za vgradnjo (45x45 cm) za masažne kade za ugradnju (45x45 cm)	3838987 534808	90,00
	ANTI-SLIP PREMAZ	protizdrsni premaz za kopalne kadi protiv klizni premaz za kupaonske kade (min. kol. 10 kos)		67,00
	Specialno čistilo KOLPA SAN Specialno sredstvo za čišćenje	karton 20 kosov / karton 20 komada (Cena za kos / Cijena na komad 6,20 EUR)	3838987 747291	124,00
	Specialno čistilo ECO SAN Specialno sredstvo za čišćenje	karton 20 kosov / karton 20 komada (Cena za kos / Cijena na komad 5,40 EUR)	3838987 572220	108,00
	Čistilo za masažne sisteme Sredstvo za čišćenje masažnih sistema	karton 10 kosov / karton 10 komada (Cena za kos / Cijena na komad 7,80 EUR)	3838987 747277	78,00



Kopalne in masažne kadi
Kade za kupanje i masažne kade

Program:

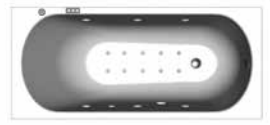
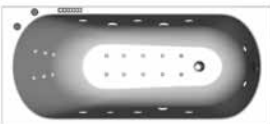
kolpa·san
BY KOLPA

















Model	Naziv in dimenzija izdelka Naziv i dimenzije produkta	Opis Opis	EAN koda EAN koda	Cena EUR Cijena EUR
Betty 170x75				
	Betty 170x75	kopalna kad za vgradnjo kada za ugradnju	3838987 565352	260,00
	A 170/63	dolga obloga duga obloga	3838987 565376	73,00
	A 75/63	kratka obloga kratka obloga	3838987 565369	45,00
	CM 160-170	podnožje kopalne kadi za oblogo podnožje kupaonske kade za oblogu	3838987 573005	119,00
	Betty E2 170x75	kopalna kad za vgradnjo kada za ugradnju višina roba kadi = 20 mm visina ruba kade = 20 mm * Ni možnosti v kombinaciji z oblogo, niti z masažnim sistemom	3838987 705345	286,00
	Vodni masažni sistem I. Vodeni masažni sistem I. PNEVMATSKI Betty 170x75	z oblogo s oblogom	3838987 513605	1.296,00
		z oblogo + mikrošobe s oblogom + mikromlaznice	3838987 513612	1.835,00
	Kombinirani (vodni in zračni) masažni sistem / Kombinirani (vodeni i zračni) masažni sistem ELEKTRONSKI Betty 170x75	z oblogo s oblogom	3838987 513629	2.483,00
		z oblogo + mikrošobe s oblogom + mikromlaznice	3838987 513636	3.023,00
	Vital masažni sistem Vital masažni sistem ELEKTRONSKI Betty 170x75	z oblogo + mikrošobe s oblogom + mikromlaznice	3838987 513643	3.981,00
Vgradnja mikrošob v kad Ugradnja mikromlaznica u kado Betty 170x75				
	Prikaz vgradnje mikrošob Prikaz ugradnje mikromlaznica Betty 170x75			

Kopalne in masažne kadi

Kade za kupanje i masažne kade

Program:

kolpa·san
BY KOLPA









Model	Naziv in dimenzija izdelka Naziv i dimenzije produkta	Opis Opis	EAN koda EAN koda	Cena EUR Cijena EUR
Dodatki za / Dodaci za Betty 170x75				
	GEYSER 	enoročna arm. s tuš ročico in polnilno /odlivno prelivno gar. za polnjenje kadi jednoročna arm. s tuš ručicom i priljev/odljev prelivnom garniturom za punjenje kada	3838987 506287	603,00
	RAINDROP 	enoročna armatura s tuš ročico in izlivom / jednoročna armatura s tuš ručicom i izljevom	3838987 726500	590,00
	UP&DOWN, WHITE	prelivna garnitura s sifonom, bela prelivna garnitura sa sifonom, bijela	3838987 922759	62,00
	PAL 650	prelivna garnitura s sifonom prelivna garnitura sa sifonom	3838987 746270	55,00
	HEADREST SOFT	vzglavnik naslon za glavu	3838987 593942	79,00
	HEADREST COAST	vzglavnik naslon za glavu	3838987 593928	103,00
	SKK	sedež za kopalno kad sjedalo za kupaonsku kadu	3838987 950943	101,00
	PKK 501	podnožje kopalne kadi za vgradnjo podnožje kupaonske kade za ugradnju	3838987 764878	28,00
	Zidni montažni set Zidni montažni set	za kopalne in tuš kadi za vgradnjo za kupaonske i tuš kade za ugradnju	3838987 704362	11,00
	Montažni set za oblogo /magnet Montažni set za oblogu / magnet	za kopalne kadi (v primeru dodatne kratke obloge) / za kupaonske kade (u primeru dodatne kratke obloge)	3838987 590750	28,00
	Suhomontažna zaključna letva Završna letva u sistemu suhe montaže	karton 25 kosov / karton 25 komada (Cena za kos / Cijena na komad 30,60 EUR)	3838987 903116	765,00
	Chromotherapie (CTL) Chromotherapie (CTL)	2 LED lučki s samostojno tipkovnico 2 LED svjetla sa samostalnom tipkovnicom		382,00
	Dve dodatni mikro šobi Dvije dodatne mikro mlaznice	za masažo stopal (kpl) za masažu stopala (kpl)		61,00
	Servisno prezračevalni pokrov z rešetko Servisno ventilacijski pokrov s rešetkom	za masažne kadi za vgradnjo (45x45 cm) za masažne kade za ugradnju (45x45 cm)	3838987 534808	90,00
	ANTI-SLIP PREMAZ	protizdrsni premaz za kopalne kadi protiv klizni premaz za kupaonske kade (min. kol. 10 kos)		67,00
	Specialno čistilo KOLPA SAN Specialno sredstvo za čišćenje	karton 20 kosov / karton 20 komada (Cena za kos / Cijena na komad 6,20 EUR)	3838987 747291	124,00
	Specialno čistilo ECO SAN Specialno sredstvo za čišćenje	karton 20 kosov / karton 20 komada (Cena za kos / Cijena na komad 5,40 EUR)	3838987 572220	108,00
	Čistilo za masažne sisteme Sredstvo za čišćenje masažnih sistema	karton 10 kosov / karton 10 komada (Cena za kos / Cijena na komad 7,80 EUR)	3838987 747277	78,00



Kopalne in masažne kadi
Kade za kupanje i masažne kade

Program:

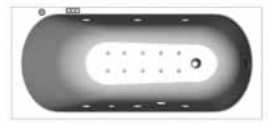
kolpa·san
BY KOLPA















Model	Naziv in dimenzija izdelka Naziv i dimenzije produkta	Opis Opis	EAN koda EAN koda	Cena EUR Cijena EUR
Betty 170x70				
	Betty 170x70	kopalna kad za vgradnjo kada za ugradnju	3838987 565383	260,00
	A 170/63	dolga obloga duga obloga	3838987 565376	73,00
	A 70/63	kratka obloga kratka obloga	3838987 565390	45,00
	CM 160-170	podnožje kopalne kadi za oblogo podnožje kupaonske kade za oblogu	3838987 573005	119,00
	Betty E2 170x70	kopalna kad za vgradnjo kada za ugradnju višina roba kadi = 20 mm visina ruba kade = 20 mm * Ni možnosti v kombinaciji z oblogo, niti z masažnim sistemom	3838987 705352	286,00
	Vodni masažni sistem I. Vodeni masažni sistem I. PNEVMATSKI Betty 170x70	z oblogo s oblogom	3838987 513568	1.296,00
		z oblogo + mikrošobe s oblogom + mikromlaznice	3838987 513575	1.835,00
	Kombinirani (vodni in zračni) masažni sistem / Kombinirani (vodeni i zračni) masažni sistem ELEKTRONSKI Betty 170x70	z oblogo s oblogom	3838987 513582	2.483,00
		z oblogo + mikrošobe s oblogom + mikromlaznice	3838987 513590	3.023,00
Vgradnja mikrošob v kad Ugradnja mikromlaznica u kadi Betty 170x70				
	Prikaz vgradnje mikrošob Prikaz ugradnje mikromlaznica Betty 170x70			

Kopalne in masažne kadi

Kade za kupanje i masažne kade

Program:

kolpa·san®







Model	Naziv in dimenzija izdelka Naziv i dimenzije produkta	Opis Opis	EAN koda EAN koda	Cena EUR Cijena EUR
Dodatki za / Dodaci za Betty 170x70				
	GEYSER 	enoročna arm. s tuš ročico in polnilno /odlivno prelivno gar. za polnjenje kadi jednoročna arm. s tuš ročicom i priljev/odljev prelivnom garnituroz za punjenje kada	3838987 506287	603,00
	RAINDROP 	enoročna armatura s tuš ročico in izlivom / jednoročna armatura s tuš ročicom i izlivom	3838987 726500	590,00
	UP&DOWN, WHITE	prelivna garnitura s sifonom, bela prelivna garnitura sa sifonom, bijela	3838987 922759	62,00
	PAL 650	prelivna garnitura s sifonom prelivna garnitura sa sifonom	3838987 746270	55,00
	HEADREST SOFT	vzglavnik naslon za glavu	3838987 593942	79,00
	HEADREST COAST	vzglavnik naslon za glavu	3838987 593928	103,00
	SKK	sedež za kopalno kad sjedalo za kupaonsku kadu	3838987 950943	101,00
	PKK 501	podnožje kopalne kadi za vgradnjo podnožje kupaonske kade za ugradnju	3838987 764878	28,00
	Zidni montažni set Zidni montažni set	za kopalne in tuš kadi za vgradnjo za kupaonske i tuš kade za ugradnju	3838987 704362	11,00
	Montažni set za oblogo /magnet Montažni set za oblogo / magnet	za kopalne kadi (v primeru dodatne kratke obloge) / za kupaonske kade (u primeru dodatne kratke obloge)	3838987 590750	28,00
	Suhomontažna zaključna letva Završna letva u sistemu suhe montaže	karton 25 kosov / karton 25 komada (Cena za kos / Cijena na komad 30,60 EUR)	3838987 903116	765,00
	Chromoterapia (CTL) Chromoterapia (CTL)	2 LED lučki s samostojno tipkovnico 2 LED svjetla sa samostalnom tipkovnicom		382,00
	Servisno prezračevalni pokrov z rešetko Servisno ventilacijski pokrov s rešetkom	za masažne kadi za vgradnjo (45x45 cm) za masažne kade za ugradnju (45x45 cm)	3838987 534808	90,00
	ANTI-SLIP PREMAZ	protizdrsni premaz za kopalne kadi protiv klizni premaz za kupaonske kade (min. kol. 10 kos)		67,00
	Specialno čistilo KOLPA SAN Specialno sredstvo za čišćenje	karton 20 kosov / karton 20 komada (Cena za kos / Cijena na komad 6,20 EUR)	3838987 747291	124,00
	Specialno čistilo ECO SAN Specialno sredstvo za čišćenje	karton 20 kosov / karton 20 komada (Cena za kos / Cijena na komad 5,40 EUR)	3838987 572220	108,00
	Čistilo za masažne sisteme Sredstvo za čišćenje masažnih sistema	karton 10 kosov / karton 10 komada (Cena za kos / Cijena na komad 7,80 EUR)	3838987 747277	78,00



Kopalne in masažne kadi

Kade za kupanje i masažne kade

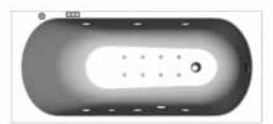













Program:kolpa·san[®]

Model	Naziv in dimenzija izdelka Naziv i dimenzije produkta	Opis Opis	EAN koda EAN koda	Cena EUR Cijena EUR
Betty 160x70				
	Betty 160x70	kopalna kad za vgradnjo kada za ugradnju	3838987 565437	260,00
	A 160/63	dolga obloga duga obloga	3838987 565444	73,00
	A 70/63	kratka obloga kratka obloga	3838987 565390	45,00
	CM 160-170	podnožje kopalne kadi za oblogo podnožje kupaonske kade za oblogu	3838987 573005	119,00
	Vodni masažni sistem I. Vodeni masažni sistem I. PNEVMATSKI Betty 160x70	z oblogo s oblogom z oblogo + mikrošobe s oblogom + mikromlaznice	3838987 513520 3838987 513537	1.296,00 1.835,00
	Kombinirani (vodni in zračni) masažni sistem / Kombinirani (vodeni i zračni) masažni sistem ELEKTRONSKI Betty 160x70	z oblogo s oblogom z oblogo + mikrošobe s oblogom + mikromlaznice	3838987 513544 3838987 513551	2.483,00 3.023,00
Vgradnja mikrošob v kad Ugradnja mikromlaznica u kadu Betty 160x70				
	Prikaz vgradnje mikrošob Prikaz ugradnje mikromlaznica Betty 160x70			

Kopalne in masažne kadi

Kade za kupanje i masažne kade

Program:kolpa·san[®]





Model	Naziv in dimenzija izdelka Naziv i dimenzije produkta	Opis Opis	EAN koda EAN koda	Cena EUR Cijena EUR
Dodatki za / Dodaci za Betty 160x70				
	GEYSER 	enoročna arm. s tuš ročico in polnilno /odlivno prelivno gar. za polnjenje kadi jednoročna arm. s tuš ročicom i priljev/odljev prelivnom garnituroom za punjenje kada	3838987 506287	603,00
	RAINDROP 	enoročna armatura s tuš ročico in izlivom / jednoročna armatura s tuš ročicom i izlivom	3838987 726500	590,00
	UP&DOWN, WHITE	prelivna garnitura s sifonom, bela prelivna garnitura sa sifonom, bijela	3838987 922759	62,00
	PAL 650	prelivna garnitura s sifonom prelivna garnitura sa sifonom	3838987 746270	55,00
	HEADREST SOFT	vzglavnik naslon za glavu	3838987 593942	79,00
	HEADREST COAST	vzglavnik naslon za glavu	3838987 593928	103,00
	SKK	sedež za kopalno kad sjedalo za kupaonsku kadu	3838987 950943	101,00
	PKK 501	podnožje kopalne kadi za vgradnjo podnožje kupaonske kade za ugradnju	3838987 764878	28,00
	Zidni montažni set Zidni montažni set	za kopalne in tuš kadi za vgradnjo za kupaonske i tuš kade za ugradnju	3838987 704362	11,00
	Montažni set za oblogo /magnet Montažni set za oblogo / magnet	za kopalne kadi (v primeru dodatne kratke obloge) / za kupaonske kade (u primeru dodatne kratke obloge)	3838987 590750	28,00
	Suhomontažna zaključna letva Završna letva u sistemu suhe montaže	karton 25 kosov / karton 25 komada (Cena za kos / Cijena na komad 30,60 EUR)	3838987 903116	765,00
	Chromoterapia (CTL) Chromoterapia (CTL)	2 LED lučki s samostojno tipkovnico 2 LED svjetla sa samostalnom tipkovnicom		382,00
	Servisno prezračevalni pokrov z rešetko Servisno ventilacijski pokrov s rešetkom	za masažne kadi za vgradnjo (45x45 cm) za masažne kade za ugradnju (45x45 cm)	3838987 534808	90,00
	ANTI-SLIP PREMAZ	protizdrsni premaz za kopalne kadi protiv klizni premaz za kupaonske kade (min. kol. 10 kos)		67,00
	Specialno čistilo KOLPA SAN Specialno sredstvo za čišćenje	karton 20 kosov / karton 20 komada (Cena za kos / Cijena na komad 6,20 EUR)	3838987 747291	124,00
	Specialno čistilo ECO SAN Specialno sredstvo za čišćenje	karton 20 kosov / karton 20 komada (Cena za kos / Cijena na komad 5,40 EUR)	3838987 572220	108,00
	Čistilo za masažne sisteme Sredstvo za čišćenje masažnih sistema	karton 10 kosov / karton 10 komada (Cena za kos / Cijena na komad 7,80 EUR)	3838987 747277	78,00



Kopalne in masažne kadi

Kade za kupanje i masažne kade

Program:**kolpa·san**
BY KOLPA















Model	Naziv in dimenzija izdelka Naziv i dimenzije produkta	Opis Opis	EAN koda EAN koda	Cena EUR Cijena EUR
Betty 150x70				
	Betty 150x70	kopalna kad za vgradnjo kada za ugradnju	3838987 565505	247,00
	A 150/63	dolga obloga duga obloga	3838987 565543	65,00
	A 70/63	kratka obloga kratka obloga	3838987 565390	45,00
	CM 120-150	podnožje kopalne kadi za oblogo podnožje kupaonske kade za oblogu	3838987 572992	119,00

Kopalne in masažne kadi

Kade za kupanje i masažne kade

Program:

kolpa·san
BY KOLPA





Model	Naziv in dimenzija izdelka Naziv i dimenzije produkta	Opis Opis	EAN koda EAN koda	Cena EUR Cijena EUR
Dodatki za / Dodaci za Betty 150x70				
	GEYSER 	enoročna arm. s tuš ročico in polnilno /odlivno prelivno gar. za polnjenje kadi jednoročna arm. s tuš ručicom i priljev/odljev prelivnom garniturom za punjenje kada	3838987 506287	603,00
	RAINDROP 	enoročna armatura s tuš ročico in izlivom / jednoročna armatura s tuš ručicom i izljevom	3838987 726500	590,00
	UP&DOWN, WHITE	prelivna garnitura s sifonom, bela prelivna garnitura sa sifonom, bijela	3838987 922759	62,00
	PAL 650	prelivna garnitura s sifonom prelivna garnitura sa sifonom	3838987 746270	55,00
	HEADREST SOFT	vzglavnik naslon za glavu	3838987 593942	79,00
	HEADREST COAST	vzglavnik naslon za glavu	3838987 593928	103,00
	SKK	sedež za kopalno kad sjedalo za kupaonsku kado	3838987 950943	101,00
	PKK 501	podnožje kopalne kadi za vgradnjo podnožje kupaonske kade za ugradnju	3838987 764878	28,00
	Zidni montažni set Zidni montažni set	za kopalne in tuš kadi za vgradnjo za kupaonske i tuš kade za ugradnju	3838987 704362	11,00
	Montažni set za oblogo /magnet Montažni set za oblogu / magnet	za kopalne kadi (v primeru dodatne kratke obloge) / za kupaonske kade (u primeru dodatne kratke obloge)	3838987 590750	28,00
	Suhomontažna zaključna letva Završna letva u sistemu suhe montaže	karton 25 kosov / karton 25 komada (Cena za kos / Cijena na komad 30,60 EUR)	3838987 903116	765,00
	Servisno prezračevalni pokrov z rešetko Servisno ventilacijski pokrov s rešetkom	za masažne kadi za vgradnjo (45x45 cm) za masažne kade za ugradnju (45x45 cm)	3838987 534808	90,00
	ANTI-SLIP PREMAZ	protizdrsni premaz za kopalne kadi protiv klizni premaz za kupaonske kade (min. kol. 10 kos)		67,00
	Specialno čistilo KOLPA SAN Specialno sredstvo za čišćenje	karton 20 kosov / karton 20 komada (Cena za kos / Cijena na komad 6,20 EUR)	3838987 747291	124,00
	Specialno čistilo ECO SAN Specialno sredstvo za čišćenje	karton 20 kosov / karton 20 komada (Cena za kos / Cijena na komad 5,40 EUR)	3838987 572220	108,00



Kopalne in masažne kadi

Kade za kupanje i masažne kade

Program:**kolpa·san**
BY KOLPA















Model	Naziv in dimenzija izdelka Naziv i dimenzije produkta	Opis Opis	EAN koda EAN koda	Cena EUR Cijena EUR
Betty 140x70				
	Betty 140x70	kopalna kad za vgradnjo kada za ugradnju	3838987 565512	233,00
	A 140/63	dolga obloga duga obloga	3838987 565550	65,00
	A 70/63	kratka obloga kratka obloga	3838987 565390	45,00
	CM 120-150	podnožje kopalne kadi za oblogo podnožje kupaonske kade za oblogu	3838987 572992	119,00

Kopalne in masažne kadi

Kade za kupanje i masažne kade

Program:

kolpa·san
BY KOLPA





Model	Naziv in dimenzija izdelka Naziv i dimenzije produkta	Opis Opis	EAN koda EAN koda	Cena EUR Cijena EUR
Dodatki za / Dodaci za Betty 140x70				
	GEYSER 	enoročna arm. s tuš ročico in polnilno /odlivno prelivno gar. za polnjenje kadi jednoročna arm. s tuš ručicom i priljev/odljev prelivnom garniturom za punjenje kada	3838987 506287	603,00
	RAINDROP 	enoročna armatura s tuš ročico in izlivom / jednoročna armatura s tuš ručicom i izljevom	3838987 726500	590,00
	UP&DOWN, WHITE	prelivna garnitura s sifonom, bela prelivna garnitura sa sifonom, bijela	3838987 922759	62,00
	PAL 650	prelivna garnitura s sifonom prelivna garnitura sa sifonom	3838987 746270	55,00
	HEADREST SOFT	vzglavnik naslon za glavu	3838987 593942	79,00
	HEADREST COAST	vzglavnik naslon za glavu	3838987 593928	103,00
	SKK	sedež za kopalno kad sjedalo za kupaonsku kadu	3838987 950943	101,00
	PKK 501	podnožje kopalne kadi za vgradnjo podnožje kupaonske kade za ugradnju	3838987 764878	28,00
	Zidni montažni set Zidni montažni set	za kopalne in tuš kadi za vgradnjo za kupaonske i tuš kade za ugradnju	3838987 704362	11,00
	Montažni set za oblogo /magnet Montažni set za oblogu / magnet	za kopalne kadi (v primeru dodatne kratke obloge) / za kupaonske kade (u primeru dodatne kratke obloge)	3838987 590750	28,00
	Suhomontažna zaključna letva Završna letva u sistemu suhe montaže	karton 25 kosov / karton 25 komada (Cena za kos / Cijena na komad 30,60 EUR)	3838987 903116	765,00
	Servisno prezračevalni pokrov z rešetko Servisno ventilacijski pokrov s rešetkom	za masažne kadi za vgradnjo (45x45 cm) za masažne kade za ugradnju (45x45 cm)	3838987 534808	90,00
	ANTI-SLIP PREMAZ	protizdrsni premaz za kopalne kadi protiv klizni premaz za kupaonske kade (min. kol. 10 kos)		67,00
	Specialno čistilo KOLPA SAN Specialno sredstvo za čišćenje	karton 20 kosov / karton 20 komada (Cena za kos / Cijena na komad 6,20 EUR)	3838987 747291	124,00
	Specialno čistilo ECO SAN Specialno sredstvo za čišćenje	karton 20 kosov / karton 20 komada (Cena za kos / Cijena na komad 5,40 EUR)	3838987 572220	108,00



Kopalne in masažne kadi

Kade za kupanje i masažne kade











Program:**kolpa·san**
BY KOLPA

Model	Naziv in dimenzija izdelka Naziv i dimenzije produkta	Opis Opis	EAN koda EAN koda	Cena EUR Cijena EUR
Betty 130x70				
	Betty 130x70	kopalna kad za vgradnjo kada za ugradnju	3838987 565529	233,00
	A 130/63	dolga obloga duga obloga	3838987 565567	65,00
	A 70/63	kratka obloga kratka obloga	3838987 565390	45,00
	CM 120-150	podnožje kopalne kadi za oblogo podnožje kupaonske kade za oblogu	3838987 572992	119,00

Kopalne in masažne kadi

Kade za kupanje i masažne kade

Program:kolpa·san[®]





Model	Naziv in dimenzija izdelka Naziv i dimenzije produkta	Opis Opis	EAN koda EAN koda	Cena EUR Cijena EUR
Dodatki za / Dodaci za Betty 130x70				
	UP&DOWN, WHITE	prelivna garnitura s sifonom, bela prelivna garnitura sa sifonom, bijela	3838987 922759	62,00
	PAL 650	prelivna garnitura s sifonom prelivna garnitura sa sifonom	3838987 746270	55,00
	HEADREST SOFT	vzglavnik naslon za glavu	3838987 593942	79,00
	HEADREST COAST	vzglavnik naslon za glavu	3838987 593928	103,00
	SKK	sedež za kopalno kad sjedalo za kupaonsku kadu	3838987 950943	101,00
	PKK 501	podnožje kopalne kadi za vgradnjo podnožje kupaonske kade za ugradnju	3838987 764878	28,00
	Zidni montažni set Zidni montažni set	za kopalne in tuš kadi za vgradnjo za kupaonske i tuš kade za ugradnju	3838987 704362	11,00
	Montažni set za oblogo / magnet Montažni set za oblogo / magnet	za kopalne kadi (v primeru dodatne kratke obloge) / za kupaonske kade (u primeru dodatne kratke obloge)	3838987 590750	28,00
	Suhomontažna zaključna letev Završna letva u sistemu suhe montaže	karton 25 kosov / karton 25 komada (Cena za kos / Cijena na komad 30,60 EUR)	3838987 903116	765,00
	Servisno prezračevalni pokrov z rešetko Servisno ventilacijski pokrov s rešetkom	za masažne kadi za vgradnjo (45x45 cm) za masažne kade za ugradnju (45x45 cm)	3838987 534808	90,00
	ANTI-SLIP PREMAZ	protizdrsni premaz za kopalne kadi protiv klizni premaz za kupaonske kade (min. kol. 10 kos)		67,00
	Specialno čištilo KOLPA SAN Specialno sredstvo za čišćenje	karton 20 kosov / karton 20 komada (Cena za kos / Cijena na komad 6,20 EUR)	3838987 747291	124,00
	Specialno čištilo ECO SAN Specialno sredstvo za čišćenje	karton 20 kosov / karton 20 komada (Cena za kos / Cijena na komad 5,40 EUR)	3838987 572220	108,00



Kopalne in masažne kadi
Kade za kupanje i masažne kade

Program:











kolpa·san
BY KOLPA

Model	Naziv in dimenzija izdelka Naziv i dimenzije produkta	Opis Opis	EAN koda EAN koda	Cena EUR Cijena EUR
Betty 120x70				
	Betty 120x70	kopalna kad za vgradnjo kada za ugradnju	3838987 565536	233,00
	A 120/63	dolga obloga duga obloga	3838987 565574	65,00
	A 70/63	kratka obloga kratka obloga	3838987 565390	45,00
	CM 120-150	podnožje kopalne kadi za oblogo podnožje kupaonske kade za oblogu	3838987 572992	119,00

Kopalne in masažne kadi

Kade za kupanje i masažne kade

Program:kolpa·san[®]

Model	Naziv in dimenzija izdelka Naziv i dimenzije produkta	Opis Opis	EAN koda EAN koda	Cena EUR Cijena EUR
Dodatki za / Dodaci za Betty 120x70				
	UP&DOWN, WHITE	prelivna garnitura s sifonom, bela prelivna garnitura sa sifonom, bijela	3838987 922759	62,00
	PAL 650	prelivna garnitura s sifonom prelivna garnitura sa sifonom	3838987 746270	55,00
	HEADREST SOFT	vzglavnik naslon za glavu	3838987 593942	79,00
	HEADREST COAST	vzglavnik naslon za glavu	3838987 593928	103,00
	SKK	sedež za kopalno kad sjedalo za kupaonsku kado	3838987 950943	101,00
	PKK 501	podnožje kopalne kadi za vgradnjo podnožje kupaonske kade za ugradnju	3838987 764878	28,00
	Zidni montažni set Zidni montažni set	za kopalne in tuš kadi za vgradnjo za kupaonske i tuš kade za ugradnju	3838987 704362	11,00
	Montažni set za oblogo / magnet Montažni set za oblogo / magnet	za kopalne kadi (v primeru dodatne kratke obloge) / za kupaonske kade (u primeru dodatne kratke obloge)	3838987 590750	28,00
	Suhomontažna zaključna letev Završna letva u sistemu suhe montaže	karton 25 kosov / karton 25 komada (Cena za kos / Cijena na komad 30,60 EUR)	3838987 903116	765,00
	Servisno prezračevalni pokrov z rešetko Servisno ventilacijski pokrov s rešetkom	za masažne kadi za vgradnjo (45x45 cm) za masažne kade za ugradnju (45x45 cm)	3838987 534808	90,00
	ANTI-SLIP PREMAZ	protizdrsni premaz za kopalne kadi protiv klizni premaz za kupaonske kade (min. kol. 10 kos)		67,00
	Specialno čistilo KOLPA SAN Specialno sredstvo za čišćenje	karton 20 kosov / karton 20 komada (Cena za kos / Cijena na komad 6,20 EUR)	3838987 747291	124,00
	Specialno čistilo ECO SAN Specialno sredstvo za čišćenje	karton 20 kosov / karton 20 komada (Cena za kos / Cijena na komad 5,40 EUR)	3838987 572220	108,00



Kopalne in masažne kadi

Kade za kupanje i masažne kade

Program:kolpa·san[®]

















Model	Naziv in dimenzija izdelka Naziv i dimenzije produkta	Opis Opis	EAN koda EAN koda	Cena EUR Cijena EUR
Adam & Eva 195x125				
	Adam & Eva 195x125	kopalna kad za vgradnjo kada za ugradnju	3838987 593201	557,00
	Adam & Eva 195x125/20	kopalna kad z oblogo kada s oblogom	3838987 593218	1.057,00
	Vodni masažni sistem I. Vodeni masažni sistem I. PNEVMATSKI Adam & Eva 195x125	z oblogo s oblogom z oblogo + mikrošobe s oblogom + mikromlaznice	3838987 576655 3838987 576662	1.820,00 2.357,00
	Kombinirani (vodni in zračni) masažni sistem / Kombinirani (vodeni i zračni) masažni sistem ELEKTRONSKI Adam & Eva 195x125	z oblogo s oblogom z oblogo + mikrošobe s oblogom + mikromlaznice	3838987 576679 3838987 576686	3.036,00 3.575,00
	Vital masažni sistem Vital masažni sistem ELEKTRONSKI Adam & Eva 195x125	z oblogo + mikrošobe s oblogom + mikromlaznice	3838987 576693	4.579,00
Vgradnja mikrošob v kad Ugradnja mikromlaznica u kadu Adam & Eva 195x125				
	Prikaz vgradnje mikrošob Prikaz ugradnje mikromlaznica Adam & Eva 195x125			

Kopalne in masažne kadi

Kade za kupanje i masažne kade

Program:

kolpa·san
BY KOLPA

Model	Naziv in dimenzija izdelka Naziv i dimenzije produkta	Opis Opis	EAN koda EAN koda	Cena EUR Cijena EUR
Dodatki za / Dodaci za Adam & Eva 195x125				
	WATERFALL	 enoročna armatura s tuš ročico in izlivom / jednoručna armatura s tuš ručicom i izlivom	3838987 734543	562,00
	GEYSER	 enoročna arm. s tuš ročico in polnilno /odlivno prelivno gar. za polnjenje kadi jednoručna arm. s tuš ručicom i priljev/odljev prelivnom garnituroom za punjenje kada	3838987 506287	603,00
	RAINDROP	 enoročna armatura s tuš ročico in izlivom / jednoručna armatura s tuš ručicom i izlivom	3838987 726500	590,00
	UP&DOWN, WHITE	prelivna garnitura s sifonom, bela prelivna garnitura sa sifonom, bijela	3838987 922759	62,00
	PAL 650	prelivna garnitura s sifonom prelivna garnitura sa sifonom	3838987 746270	55,00
	HEADREST COAST	vzglavnik naslon za glavu	3838987 593928	103,00
	PKK 800	podnožje kopalne kadi za vgradnjo podnožje kupaonske kade za ugradnju	3838987 795100	47,00
	Zidni montažni set Zidni montažni set	za kopalne in tuš kadi za vgradnjo za kupaonske i tuš kade za ugradnju	3838987 704362	11,00
	Montažni set za oblogo /magnet Montažni set za oblogo / magnet	za kopalne kadi (v primeru dodatne kratke obloge) / za kupaonske kade (u primeru dodatne kratke obloge)	3838987 590750	28,00
	Suhomontažna zaključna letva Završna letva u sistemu suhe montaže	karton 25 kosov / karton 25 komada (Cena za kos / Cijena na komad 30,60 EUR)	3838987 903116	765,00
	Chromoterapia (CTL) Chromoterapia (CTL)	2 LED lučki s samostojno tipkovnico 2 LED svjetla sa samostalnom tipkovnicom		382,00
	Dve dodatni mikro šobi Dvije dodatne mikro mlaznice	za masažo stopal (kpl) za masažu stopala (kpl)		61,00
	Servisno prezračevalni pokrov z rešetko Servisno ventilacijski pokrov s rešetkom	za masažne kadi za vgradnjo (45x45 cm) za masažne kade za ugradnju (45x45 cm)	3838987 534808	90,00
	ANTI-SLIP PREMAZ	protizdrsni premaz za kopalne kadi protiv klizni premaz za kupaonske kade (min. kol. 10 kos)		67,00
	Specialno čistilo KOLPA SAN Specialno sredstvo za čišćenje	karton 20 kosov / karton 20 komada (Cena za kos / Cijena na komad 6,20 EUR)	3838987 747291	124,00
	Specialno čistilo ECO SAN Specialno sredstvo za čišćenje	karton 20 kosov / karton 20 komada (Cena za kos / Cijena na komad 5,40 EUR)	3838987 572220	108,00
	Čistilo za masažne sisteme Sredstvo za čišćenje masažnih sistema	karton 10 kosov / karton 10 komada (Cena za kos / Cijena na komad 7,80 EUR)	3838987 747277	78,00





Kopalne in masažne kadi
Kade za kupanje i masažne kade

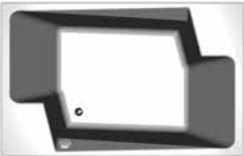
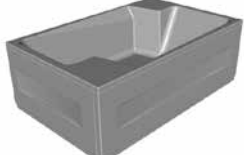

Kopalne in masažne kadi

Kade za kupanje i masažne kade

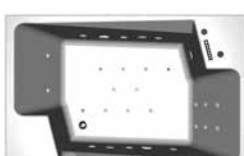
Program:kolpa·san[®]
BY KOLPA















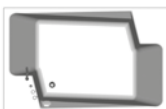

Model	Naziv in dimenzija izdelka Naziv i dimenzije produkta	Opis Opis	EAN koda EAN koda	Cena EUR Cijena EUR
Nabucco 190x120				
	Nabucco 190x120	kopalna kad za vgradnjo kada za ugradnju	3838987 740360	581,00
	Nabucco 190/0	kopalna kad z oblogo kada s oblogom	3838987 787419	1.033,00
	Vodni masažni sistem I. Vodeni masažni sistem I. PNEVMATSKI Nabucco 190x120	z oblogo s oblogom z oblogo + mikrošobe s oblogom + mikromlaznice	3838987 794783 3838987 913276	1.784,00 2.321,00
	Kombinirani (vodni in zračni) masažni sistem / Kombinirani (vodeni i zračni) masažni sistem ELEKTRONSKI Nabucco 190x120	z oblogo s oblogom z oblogo + mikrošobe s oblogom + mikromlaznice	3838987 960034 3838987 718758	3.001,00 3.540,00
	Vital masažni sistem Vital masažni sistem ELEKTRONSKI Nabucco 190x120	z oblogo + mikrošobe s oblogom + mikromlaznice	3838987 571698	4.541,00
Vgradnja mikrošob v kad Ugradnja mikromlaznica u kadu Nabucco 190x120				
	Prikaz vgradnje mikrošob Prikaz ugradnje mikromlaznica Nabucco 190x120			

Kopalne in masažne kadi

Kade za kupanje i masažne kade

Program:

kolpa·san
BY KOLPA

Model	Naziv in dimenzija izdelka Naziv i dimenzije produkta	Opis Opis	EAN koda EAN koda	Cena EUR Cijena EUR
Dodatki za / Dodaci za Nabucco 190x120				
	WATERFALL 	enoročna armatura s tuš ročico in izlivom / jednoručna armatura s tuš ručicom i izljevom	3838987 734543	562,00
	GEYSER 	enoročna arm. s tuš ročico in polnilno /odlivno prelivno gar. za polnjenje kadi jednoručna arm. s tuš ručicom i priljev/odljev prelivnom garnituroom za punjenje kada	3838987 506287	603,00
	RAINDROP 	enoročna armatura s tuš ročico in izlivom / jednoručna armatura s tuš ručicom i izljevom	3838987 726500	590,00
	UP&DOWN, WHITE	prelivna garnitura s sifonom, bela prelivna garnitura sa sifonom, bijela	3838987 922759	62,00
	PAL 650	prelivna garnitura s sifonom prelivna garnitura sa sifonom	3838987 746270	55,00
	HEADREST SOFT	vzglavnik naslon za glavu	3838987 593942	79,00
	HEADREST COAST		3838987 593928	103,00
	PKK 800	podnožje kopalne kadi za vgradnjo podnožje kupaonske kade za ugradnju	3838987 795100	47,00
	Zidni montažni set Zidni montažni set	za kopalne in tuš kadi za vgradnjo za kupaonske i tuš kade za ugradnju	3838987 704362	11,00
	Montažni set za oblogo /magnet Montažni set za oblogu / magnet	za kopalne kadi (v primeru dodatne kratke obloge) / za kupaonske kade (u primeru dodatne kratke obloge)	3838987 590750	28,00
	Suhomontažna zaključna letev Završna letva u sistemu suhe montaže	karton 25 kosov / karton 25 komada (Cena za kos / Cijena na komad 30,60 EUR)	3838987 903116	765,00
	Chromoterapia (CTL) Chromoterapia (CTL)	2 LED lučki s samostojno tipkovnicom 2 LED svjetla sa samostalnom tipkovnicom		382,00
	Dve dodatni mikro šobi Dvije dodatne mikro mlaznice	za masažo stopal (kpl) za masažu stopala (kpl)		61,00
	Servisno prezračevalni pokrov z rešetko Servisno ventilacijski pokrov s rešetkom	za masažne kadi za vgradnjo (45x45 cm) za masažne kade za ugradnju (45x45 cm)	3838987 534808	90,00
	ANTI-SLIP PREMAZ	protizdrnsni premaz za kopalne kadi protiv klizni premaz za kupaonske kade (min. kol. 10 kos)		67,00
	Specijalno čištilo KOLPA SAN Specijalno sredstvo za čišćenje	karton 20 kosov / karton 20 komada (Cena za kos / Cijena na komad 6,20 EUR)	3838987 747291	124,00
	Specijalno čištilo ECO SAN Specijalno sredstvo za čišćenje	karton 20 kosov / karton 20 komada (Cena za kos / Cijena na komad 5,40 EUR)	3838987 572220	108,00
	Čištilo za masažne sisteme Sredstvo za čišćenje masažnih sistema	karton 10 kosov / karton 10 komada (Cena za kos / Cijena na komad 7,80 EUR)	3838987 747277	78,00









Kopalne in masažne kadi

Kade za kupanje i masažne kade

Program:

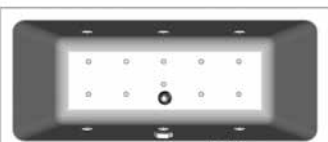
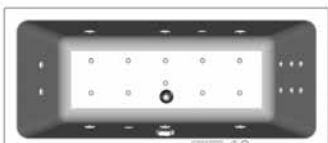







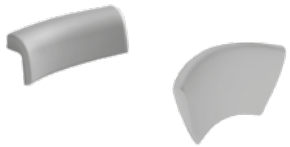

kolpa·san®

Model	Naziv in dimenzija izdelka Naziv i dimenzije produkta	Opis Opis	EAN koda EAN koda	Cena EUR Cijena EUR
Elektra 190x90				
	Elektra 190x90	kopalna kad za vgradnjo kada za ugradnju	3838987 740629	428,00
	A 190/63	dolga obloga duga obloga	3838987 565468	87,00
	A 90/63	kratka obloga kratka obloga	3838987 565413	55,00
	CM 180-200	podnožje kopalne kadi za oblogo podnožje kupaonske kade za oblogu	3838987 573012	119,00
	Vodni masažni sistem I. Vodeni masažni sistem I. PNEVMATSKI Elektra 190x90	z oblogo s oblogom z oblogo + mikrošobe s oblogom + mikromlaznice	3838987 703334 3838987 703358	1.452,00 1.989,00
	Kombinirani (vodni in zračni) masažni sistem / Kombinirani (vodeni i zračni) masažni sistem ELEKTRONSKI Elektra 190x90	z oblogo s oblogom z oblogo + mikrošobe s oblogom + mikromlaznice	3838987 991397 3838987 591276	2.666,00 3.206,00
	Vital masažni sistem Vital masažni sistem ELEKTRONSKI Elektra 190x90	z oblogo + mikrošobe s oblogom + mikromlaznice	3838987 703471	4.208,00
Vgradnja mikrošob v kad Ugradnja mikromlaznica u kadu Elektra 190x90				
	Prikaz vgradnje mikrošob Prikaz ugradnje mikromlaznica Elektra 190x90			

Kopalne in masažne kadi

Kade za kupanje i masažne kade

Program:kolpa·san[®]





Model	Naziv in dimenzija izdelka Naziv i dimenzije produkta	Opis Opis	EAN koda EAN koda	Cena EUR Cijena EUR
Dodatki za / Dodaci za Elektra 190x90				
	UP&DOWN, WHITE	prelivna garnitura s sifonom, bela preljevna garnitura sa sifonom, bijela	3838987 922759	62,00
	PAL 650	prelivna garnitura s sifonom preljevna garnitura sa sifonom	3838987 746270	55,00
	HEADREST SOFT	vzglavnik naslon za glavu	3838987 593942	79,00
	HEADREST COAST		3838987 593928	103,00
	PKK 800	podnožje kopalne kadi za vgradnjo podnožje kupaonske kade za ugradnju	3838987 795100	47,00
	Zidni montažni set Zidni montažni set	za kopalne in tuš kadi za vgradnjo za kupaonske i tuš kade za ugradnju	3838987 704362	11,00
	Montažni set za oblogo /magnet Montažni set za oblogo / magnet	za kopalne kadi (v primeru dodatne kratke obloge) / za kupaonske kade (u primeru dodatne kratke obloge)	3838987 590750	28,00
	Suhomontažna zaključna letva Završna letva u sistemu suhe montaže	karton 25 kosov / karton 25 komada (Cena za kos / Cijena na komad 30,60 EUR)	3838987 903116	765,00
	Chromotherapia (CTL) Chromotherapia (CTL)	2 LED lučki s samostojno tipkovnico 2 LED svjetla sa samostalnom tipkovnicom		382,00
	Dve dodatni mikro šobi Dvije dodatne mikro mlaznice	za masažo stopal (kpl) za masažu stopala (kpl)		61,00
	Servisno prezračevalni pokrov z rešetko Servisno ventilacijski pokrov s rešetkom	za masažne kadi za vgradnjo (45x45 cm) za masažne kade za ugradnju (45x45 cm)	3838987 534808	90,00
	ANTI-SLIP PREMAZ	protizdrsni premaz za kopalne kadi protiv klizni premaz za kupaonske kade (min. kol. 10 kos)		67,00
	Specialno čistilo KOLPA SAN Specialno sredstvo za čišćenje	karton 20 kosov / karton 20 komada (Cena za kos / Cijena na komad 6,20 EUR)	3838987 747291	124,00
	Specialno čistilo ECO SAN Specialno sredstvo za čišćenje	karton 20 kosov / karton 20 komada (Cena za kos / Cijena na komad 5,40 EUR)	3838987 572220	108,00
	Čistilo za masažne sisteme Sredstvo za čišćenje masažnih sistema	karton 10 kosov / karton 10 komada (Cena za kos / Cijena na komad 7,80 EUR)	3838987 747277	78,00



Kopalne in masažne kadi
Kade za kupanje i masažne kade

Program:

kolpa·san
BY KOLPA

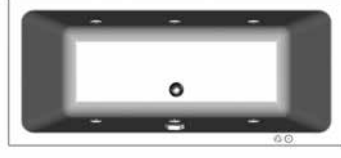
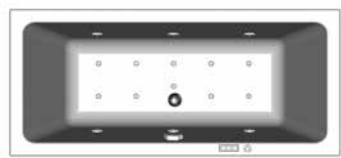
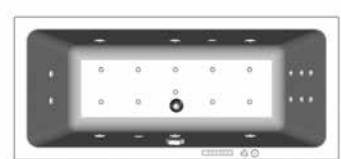
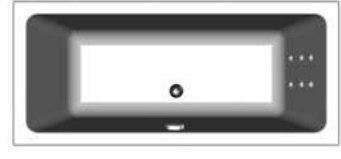









Model	Naziv in dimenzija izdelka Naziv i dimenzije produkta	Opis Opis	EAN koda EAN koda	Cena EUR Cijena EUR
Elektra 180x80				
	Elektra 180x80	kopalna kad za vgradnjo kupaonska kada za ugradnju	3838987 739135	355,00
	A 180/63	dolga obloga duga obloga	3838987 565215	73,00
	A 80/63	kratka obloga kratka obloga	3838987 565222	49,00
	CM 180-200	podnožje kopalne kadi za oblogo podnožje kupaonske kade za oblogu	3838987 573012	119,00
	Vodni masažni sistem I. Vodeni masažni sistem I. PNEVMATSKI Elektra 180x80	z oblogo s oblogom	3838987 703075	1.388,00
		z oblogo + mikrošobe s oblogom + mikromlaznice	3838987 703150	1.926,00
	Kombinirani (vodni in zračni) masažni sistem / Kombinirani (vodeni i zračni) masažni sistem ELEKTRONSKI Elektra 180x80	z oblogo s oblogom	3838987 735366	2.605,00
		z oblogo + mikrošobe s oblogom + mikromlaznice	3838987 706199	3.143,00
	Vital masažni sistem Vital masažni sistem ELEKTRONSKI Elektra 180x80	z oblogo + mikrošobe s oblogom + mikromlaznice	3838987 725442	4.144,00
Vgradnja mikrošob v kad Ugradnja mikromlaznica u kadu Elektra 180x80				
	Prikaz vgradnje mikrošob Prikaz ugradnje mikromlaznica Elektra 180x80			

Kopalne in masažne kadi

Kade za kupanje i masažne kade

Program:

kolpa·san®







Model	Naziv in dimenzija izdelka Naziv i dimenzije produkta	Opis Opis	EAN koda EAN koda	Cena EUR Cijena EUR
Dodatki za / Dodaci za Elektra 180x80				
	UP&DOWN, WHITE	prelivna garnitura s sifonom, bela preljevna garnitura sa sifonom, bijela	3838987 922759	62,00
	PAL 650	prelivna garnitura s sifonom preljevna garnitura sa sifonom	3838987 746270	55,00
	HEADREST SOFT	vzglavnik naslon za glavu	3838987 593942	79,00
	HEADREST COAST		3838987 593928	103,00
	PKK 501	podnožje kopalne kadi za vgradnjo podnožje kupaonske kade za ugradnju	3838987 764878	28,00
	Zidni montažni set Zidni montažni set	za kopalne in tuš kadi za vgradnjo za kupaonske i tuš kade za ugradnju	3838987 704362	11,00
	Montažni set za oblogo / magnet Montažni set za oblogo / magnet	za kopalne kadi (v primeru dodatne kratke obloge) / za kupaonske kade (u primeru dodatne kratke obloge)	3838987 590750	28,00
	Suhomontažna zaključna letva Završna letva u sistemu suhe montaže	karton 25 kosov / karton 25 komada (Cena za kos / Cijena na komad 30,60 EUR)	3838987 903116	765,00
	Chromotherapia (CTL) Chromotherapia (CTL)	2 LED lučki s samostojno tipkovnicom 2 LED svjetla sa samostalnom tipkovnicom		382,00
	Dve dodatni mikro šobi Dvije dodatne mikro mlaznice	za masažo stopal (kpl) za masažu stopala (kpl)		61,00
	Servisno prezračevalni pokrov z rešetko Servisno ventilacijski pokrov s rešetkom	za masažne kadi za vgradnjo (45x45 cm) za masažne kade za ugradnju (45x45 cm)	3838987 534808	90,00
	ANTI-SLIP PREMAZ	protizdrsni premaz za kopalne kadi protiv klizni premaz za kupaonske kade (min. kol. 10 kos)		67,00
	Specialno čistoilo KOLPA SAN Specialno sredstvo za čišćenje	karton 20 kosov / karton 20 komada (Cena za kos / Cijena na komad 6,20 EUR)	3838987 747291	124,00
	Specialno čistoilo ECO SAN Specialno sredstvo za čišćenje	karton 20 kosov / karton 20 komada (Cena za kos / Cijena na komad 5,40 EUR)	3838987 572220	108,00
	Čistilo za masažne sisteme Sredstvo za čišćenje masažnih sistema	karton 10 kosov / karton 10 komada (Cena za kos / Cijena na komad 7,80 EUR)	3838987 747277	78,00

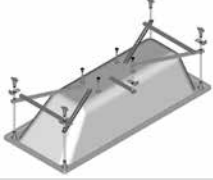

Kopalne in masažne kadi
Kade za kupanje i masažne kade

Program:

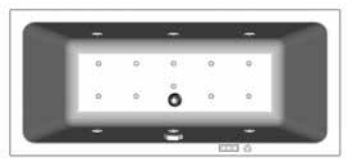
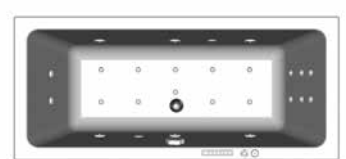
kolpa·san
BY KOLPA











Model	Naziv in dimenzija izdelka Naziv i dimenzije produkta	Opis Opis	EAN koda EAN koda	Cena EUR Cijena EUR
Elektra 170x80				
	Elektra 170x80	kopalna kad za vgradnjo kada za ugradnju	3838987 740667	345,00
	A 170/63	dolga obloga duga obloga	3838987 565376	73,00
	A 80/63	kratka obloga kratka obloga	3838987 565222	49,00
	CM 160-170	podnožje kopalne kadi za oblogo podnožje kupaonske kade za oblogu	3838987 573005	119,00
	Vodni masažni sistem I. Vodeni masažni sistem I. PNEVMATSKI Elektra 170x80	z oblogo s oblogom	3838987 702771	1.377,00
		z oblogo + mikrošobe s oblogom + mikromlaznice	3838987 702801	1.916,00
	Kombinirani (vodni in zračni) masažni sistem / Kombinirani (vodeni i zračni) masažni sistem ELEKTRONSKI Elektra 170x80	z oblogo s oblogom	3838987 591207	2.594,00
		z oblogo + mikrošobe s oblogom + mikromlaznice	3838987 591214	3.132,00
	Vital masažni sistem Vital masažni sistem ELEKTRONSKI Elektra 170x80	z oblogo + mikrošobe s oblogom + mikromlaznice	3838987 702931	4.134,00
Vgradnja mikrošob v kad Ugradnja mikromlaznica u kadu Elektra 170x80				
	Prikaz vgradnje mikrošob Prikaz ugradnje mikromlaznica Elektra 170x80			

Kopalne in masažne kadi

Kade za kupanje i masažne kade

Program:

kolpa·san®



Model	Naziv in dimenzija izdelka Naziv i dimenzije produkta	Opis Opis	EAN koda EAN koda	Cena EUR Cijena EUR
Dodatki za / Dodaci za Elektra 170x80				
	UP&DOWN, WHITE	prelivna garnitura s sifonom, bela preljevna garnitura sa sifonom, bijela	3838987 922759	62,00
	PAL 650	prelivna garnitura s sifonom preljevna garnitura sa sifonom	3838987 746270	55,00
	HEADREST SOFT	vzglavnik naslon za glavu	3838987 593942	79,00
	HEADREST COAST		3838987 593928	103,00
	PKK 501	podnožje kopalne kadi za vgradnjo podnožje kupaonske kade za ugradnju	3838987 764878	28,00
	Zidni montažni set Zidni montažni set	za kopalne in tuš kadi za vgradnjo za kupaonske i tuš kade za ugradnju	3838987 704362	11,00
	Montažni set za oblogo/magnet Montažni set za oblogu / magnet	za kopalne kadi (v primeru dodatne kratke obloge) / za kupaonske kade (u primeru dodatne kratke obloge)	3838987 590750	28,00
	Suhomontažna zaključna letev Završna letva u sistemu suhe montaže	karton 25 kosov / karton 25 komada (Cena za kos / Cijena na komad 30,60 EUR)	3838987 903116	765,00
	Chromoterapia (CTL) Chromoterapia (CTL)	2 LED lučki s samostojno tipkovnicom 2 LED svjetla sa samostalnom tipkovnicom		382,00
	Dve dodatni mikro šobi Dvije dodatne mikro mlaznice	za masažo stopal (kpl) za masažu stopala (kpl)		61,00
	Servisno prezračevalni pokrov z rešetko Servisno ventilacijski pokrov s rešetkom	za masažne kadi za vgradnjo (45x45 cm) za masažne kade za ugradnju (45x45 cm)	3838987 534808	90,00
	ANTI-SLIP PREMAZ	protizdrsni premaz za kopalne kadi protiv klizni premaz za kupaonske kade (min. kol. 10 kos)		67,00
	Specialno čistilo KOLPA SAN Specialno sredstvo za čišćenje	karton 20 kosov / karton 20 komada (Cena za kos / Cijena na komad 6,20 EUR)	3838987 747291	124,00
	Specialno čistilo ECO SAN Specialno sredstvo za čišćenje	karton 20 kosov / karton 20 komada (Cena za kos / Cijena na komad 5,40 EUR)	3838987 572220	108,00
	Čistilo za masažne sisteme Sredstvo za čišćenje masažnih sistema	karton 10 kosov / karton 10 komada (Cena za kos / Cijena na komad 7,80 EUR)	3838987 747277	78,00



Kopalne in masažne kadi
Kade za kupanje i masažne kade

Program:



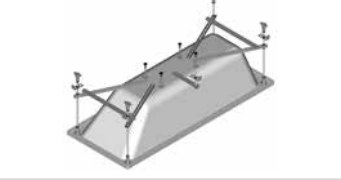
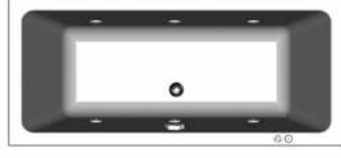
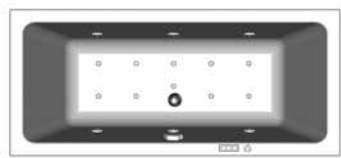
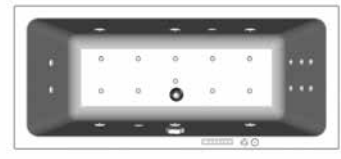
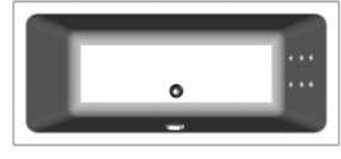









kolpa·san
BY KOLPA

Model	Naziv in dimenzija izdelka Naziv i dimenzije produkta	Opis Opis	EAN koda EAN koda	Cena EUR Cijena EUR
Elektra 170x75				
	Elektra 170x75	kopalna kad za vgradnjo kada za ugradnju	3838987 740674	327,00
	A 170/63	dolga obloga duga obloga	3838987 565376	73,00
	A 75/63	kratka obloga kratka obloga	3838987 565369	45,00
	CM 160-170	podnožje kopalne kadi za oblogo podnožje kupaonske kade za oblogu	3838987 573005	119,00
	Vodni masažni sistem I. Vodeni masažni sistem I. PNEVMATSKI Elektra 170x75	z oblogo s oblogom	3838987 931454	1.366,00
		z oblogo + mikrošobe s oblogom + mikromlaznice	3838987 931478	1.905,00
	Kombinirani (vodni in zračni) masažni sistem / Kombinirani (vodeni i zračni) masažni sistem ELEKTRONSKI Elektra 170x75	z oblogo s oblogom	3838987 757696	2.583,00
		z oblogo + mikrošobe s oblogom + mikromlaznice	3838987 952534	3.123,00
	Vital masažni sistem Vital masažni sistem ELEKTRONSKI Elektra 170x75	z oblogo + mikrošobe s oblogom + mikromlaznice	3838987 950752	4.125,00
Vgradnja mikrošob v kad Ugradnja mikromlaznica u kadu Elektra 170x75				
	Prikaz vgradnje mikrošob Prikaz ugradnje mikromlaznica Elektra 170x75			

Kopalne in masažne kadi

Kade za kupanje i masažne kade

Program:kolpa·san[®]





Model	Naziv in dimenzija izdelka Naziv i dimenzije produkta	Opis Opis	EAN koda EAN koda	Cena EUR Cijena EUR
Dodatki za / Dodaci za Elektra 170x75	 UP&DOWN, WHITE	prelivna garnitura s sifonom, bela preljevna garnitura sa sifonom, bijela	3838987 922759	62,00
	 PAL 650	prelivna garnitura s sifonom preljevna garnitura sa sifonom	3838987 746270	55,00
	HEADREST SOFT	vzglavnik naslon za glavu	3838987 593942	79,00
	HEADREST COAST		3838987 593928	103,00
	SKK	sedež za kopalno kad sjedalo za kupaonsku kadu	3838987 950943	101,00
	PKK 501	podnožje kopalne kadi za vgradnjo podnožje kupaonske kade za ugradnju	3838987 764878	28,00
	Zidni montažni set Zidni montažni set	za kopalne in tuš kadi za vgradnjo za kupaonske i tuš kade za ugradnju	3838987 704362	11,00
	Montažni set za oblogo / magnet Montažni set za oblogu / magnet	za kopalne kadi (v primeru dodatne kratke obloge) / za kupaonske kade (u primeru dodatne kratke obloge)	3838987 590750	28,00
	Suhomontažna zaključna letva Završna letva u sistemu suhe montaže	karton 25 kosov / karton 25 komada (Cena za kos / Cijena na komad 30,60 EUR)	3838987 903116	765,00
	Chromotherapia (CTL) Chromotherapia (CTL)	2 LED lučki s samostojno tipkovnico 2 LED svjetla sa samostalnom tipkovnicom		382,00
	Dve dodatni mikro šobi Dvije dodatne mikro mlaznice	za masažo stopal (kpl) za masažu stopala (kpl)		61,00
	Servisno prezračevalni pokrov z rešetko Servisno ventilacijski pokrov s rešetkom	za masažne kadi za vgradnjo (45x45 cm) za masažne kade za ugradnju (45x45 cm)	3838987 534808	90,00
	ANTI-SLIP PREMAZ	protizdrsni premaz za kopalne kadi protiv klizni premaz za kupaonske kade (min. kol. 10 kos)		67,00
	Specialno čistilo KOLPA SAN Specialno sredstvo za čišćenje	karton 20 kosov / karton 20 komada (Cena za kos / Cijena na komad 6,20 EUR)	3838987 747291	124,00
	Specialno čistilo ECO SAN Specialno sredstvo za čišćenje	karton 20 kosov / karton 20 komada (Cena za kos / Cijena na komad 5,40 EUR)	3838987 572220	108,00
	Čistilo za masažne sisteme Sredstvo za čišćenje masažnih sistema	karton 10 kosov / karton 10 komada (Cena za kos / Cijena na komad 7,80 EUR)	3838987 747277	78,00



Kopalne in masažne kadi

Kade za kupanje i masažne kade

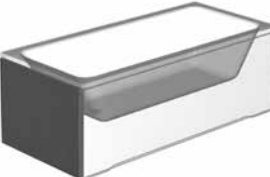









Program:kolpa·san[®]

Model	Naziv in dimenzija izdelka Naziv i dimenzije produkta	Opis Opis	EAN koda EAN koda	Cena EUR Cijena EUR
Elektra 170x70				
	Elektra 170x70	kopalna kad za vgradnjo kada za ugradnju	3838987 740681	321,00
	A 170/63	dolga obloga duga obloga	3838987 565376	73,00
	A 70/63	kratka obloga kratka obloga	3838987 565390	45,00
	CM 160-170	podnožje kopalne kadi za oblogo podnožje kupaonske kade za oblogu	3838987 573005	119,00

Kopalne in masažne kadi

Kade za kupanje i masažne kade

Program:kolpa·san[®]

Model	Naziv in dimenzija izdelka Naziv i dimenzije produkta	Opis Opis	EAN koda EAN koda	Cena EUR Cijena EUR
Dodatki za / Dodaci za Elektra 170x70	 UP&DOWN, WHITE	prelivna garnitura s sifonom, bela preljevna garnitura sa sifonom, bijela	3838987 922759	62,00
	 PAL 650	prelivna garnitura s sifonom preljevna garnitura sa sifonom	3838987 746270	55,00
	HEADREST SOFT	vzglavnik naslon za glavu	3838987 593942	79,00
	HEADREST COAST		3838987 593928	103,00
	SKK	sedež za kopalno kad sjedalo za kupaonsku kadu	3838987 950943	101,00
	PKK 501	podnožje kopalne kadi za vgradnjo podnožje kupaonske kade za ugradnju	3838987 764878	28,00
	Zidni montažni set Zidni montažni set	za kopalne in tuš kadi za vgradnjo za kupaonske i tuš kade za ugradnju	3838987 704362	11,00
	Montažni set za oblogo / magnet Montažni set za oblogu / magnet	za kopalne kadi (v primeru dodatne kratke obloge) / za kupaonske kade (u primeru dodatne kratke obloge)	3838987 590750	28,00
	Suhomontažna zaključna letva Završna letva u sistemu suhe montaže	karton 25 kosov / karton 25 komada (Cena za kos / Cijena na komad 30,60 EUR)	3838987 903116	765,00
	Servisno prezračevalni pokrov z rešetko Servisno ventilacijski pokrov s rešetkom	za kopalne kadi za vgradnjo (45x45 cm) za kupaonske kade za ugradnju (45x45 cm)	3838987 534808	90,00
	ANTI-SLIP PREMAZ	protizdrsni premaz za kopalne kadi protiv klizni premaz za kupaonske kade (min. kol. 10 kos)		67,00
	Specialno čistilo KOLPA SAN Specialno sredstvo za čišćenje	karton 20 kosov / karton 20 komada (Cena za kos / Cijena na komad 6,20 EUR)	3838987 747291	124,00
	Specialno čistilo ECO SAN Specialno sredstvo za čišćenje	karton 20 kosov / karton 20 komada (Cena za kos / Cijena na komad 5,40 EUR)	3838987 572220	108,00









Kopalne in masažne kadi

Kade za kupanje i masažne kade

Program:

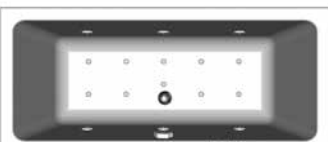
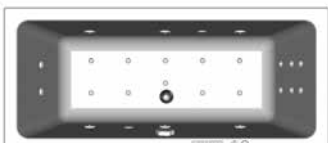
kolpa·san®













Model	Naziv in dimenzija izdelka Naziv i dimenzije produkta	Opis Opis	EAN koda EAN koda	Cena EUR Cijena EUR
Elektra 160x75				
	Elektra 160x75	kopalna kad za vgradnjo kada za ugradnju	3838987 740704	321,00
	A 160/63	dolga obloga duga obloga	3838987 565444	73,00
	A 75/63	kratka obloga kratka obloga	3838987 565369	45,00
	CM 160-170	podnožje kopalne kadi za oblogo podnožje kupaonske kade za oblogu	3838987 573005	119,00
	Vodni masažni sistem I. Vodeni masažni sistem I. PNEVMATSKI Elektra 160x75	z oblogo s oblogom z oblogo + mikrošobe s oblogom + mikromlaznice	3838987 931683 3838987 931720	1.360,00 1.899,00
	Kombinirani (vodni in zračni) masažni sistem / Kombinirani (vodeni i zračni) masažni sistem ELEKTRONSKI Elektra 160x75	z oblogo s oblogom z oblogo + mikrošobe s oblogom + mikromlaznice	3838987 591146 3838987 591153	2.578,00 3.117,00
	Vital masažni sistem Vital masažni sistem ELEKTRONSKI Elektra 160x75	z oblogo + mikrošobe s oblogom + mikromlaznice	3838987 950776	4.118,00
Vgradnja mikrošob v kad Ugradnja mikromlaznica u kadu Elektra 160x75				
	Prikaz vgradnje mikrošob Prikaz ugradnje mikromlaznica Elektra 160x75			

Kopalne in masažne kadi

Kade za kupanje i masažne kade

Program:

kolpa·san®

Model	Naziv in dimenzija izdelka Naziv i dimenzije produkta	Opis Opis	EAN koda EAN koda	Cena EUR Cijena EUR
Dodatki za / Dodaci za Elektra 160x75				
	UP&DOWN, WHITE	prelivna garnitura s sifonom, bela preljevna garnitura sa sifonom, bijela	3838987 922759	62,00
	PAL 650	prelivna garnitura s sifonom preljevna garnitura sa sifonom	3838987 746270	55,00
	HEADREST SOFT	vzglavnik naslon za glavu	3838987 593942	79,00
	HEADREST COAST		3838987 593928	103,00
	SKK	sedež za kopalno kad sjedalo za kupaonsku kadu	3838987 950943	101,00
	PKK 501	podnožje kopalne kadi za vgradnjo podnožje kupaonske kade za ugradnju	3838987 764878	28,00
	Zidni montažni set Zidni montažni set	za kopalne in tuš kadi za vgradnjo za kupaonske i tuš kade za ugradnju	3838987 704362	11,00
	Montažni set za oblogo / magnet Montažni set za oblogu / magnet	za kopalne kadi (v primeru dodatne kratke obloge) / za kupaonske kade (u primeru dodatne kratke obloge)	3838987 590750	28,00
	Suhomontažna zaključna letev Završna letva u sistemu suhe montaže	karton 25 kosov / karton 25 komada (Cena za kos / Cijena na komad 30,60 EUR)	3838987 903116	765,00
	Chromotherapia (CTL) Chromotherapia (CTL)	2 LED lučki s samostojno tipkovnico 2 LED svjetla sa samostalnom tipkovnicom		382,00
	Dve dodatni mikro šobi Dvije dodatne mikro mlaznice	za masažo stopal (kpl) za masažu stopala (kpl)		61,00
	Servisno prezračevalni pokrov z rešetko Servisno ventilacijski pokrov s rešetkom	za masažne kadi za vgradnjo (45x45 cm) za masažne kade za ugradnju (45x45 cm)	3838987 534808	90,00
	ANTI-SLIP PREMAZ	protizdrsni premaz za kopalne kadi protiv klizni premaz za kupaonske kade (min. kol. 10 kos)		67,00
	Specialno čištilo KOLPA SAN Specialno sredstvo za čišćenje	karton 20 kosov / karton 20 komada (Cena za kos / Cijena na komad 6,20 EUR)	3838987 747291	124,00
	Specialno čištilo ECO SAN Specialno sredstvo za čišćenje	karton 20 kosov / karton 20 komada (Cena za kos / Cijena na komad 5,40 EUR)	3838987 572220	108,00
	Čistilo za masažne sisteme Sredstvo za čišćenje masažnih sistema	karton 10 kosov / karton 10 komada (Cena za kos / Cijena na komad 7,80 EUR)	3838987 747277	78,00



Kopalne in masažne kadi

Kade za kupanje i masažne kade











Program:kolpa·san[®]

Model	Naziv in dimenzija izdelka Naziv i dimenzije produkta	Opis Opis	EAN koda EAN koda	Cena EUR Cijena EUR
Samson 180x160				
	Samson 180x160	kopalna kad za vgradnjo kada za ugradnju	3838987 740346	689,00
	Samson 180x160/20	kopalna kad z dvema oblogama kupaonska kada s dvije obloge	3838987 710004	1.157,00
	Samson 180x160/40	kopalna kad s štirimi oblogami kupaonska kada sa četiri obloge	3838987 722250	1.455,00
	Kombinirani (vodni in zračni) masažni sistem Kombinirani (vodeni i zračni) masažni sistem ELEKTRONSKI Samson 180x160	masažna kopalna kad za vgradnjo masažna kada za ugradnju	3838987 731344	3.566,00
	Samson 180/20	masažna kad z dvema oblogama masažna kada sa dvije obloge	3838987 995470	3.811,00
	Samson 180/40	masažna kad s štirimi oblogami masažna kada sa četiri obloge	3838987 995487	3.944,00
	Vital masažni sistem + mikrošobe Vital masažni sistem ELEKTRONSKI Samson 180x160	masažna kopalna kad za vgradnjo masažna kada za ugradnju	3838987 513933	4.719,00
	Samson 180/20	masažna kad z dvema oblogama masažna kada sa dvije obloge	3838987 513902	4.862,00
	Samson 180/40	masažna kad s štirimi oblogami masažna kada sa četiri obloge	3838987 513896	5.050,00

Kopalne in masažne kadi

Kade za kupanje i masažne kade

Program:**kolpa·san**
BY KOLPA

Model	Naziv in dimenzija izdelka Naziv i dimenzije produkta	Opis Opis	EAN koda EAN koda	Cena EUR Cijena EUR
Dodatki za / Dodaci za Samson 180x160				
	WATERFALL	enoročna armatura s tuš ročico in izlivom / jednoručna armatura s tuš ručicom i izljevom	3838987 734543	562,00
	GEYSER	enoročna arm. s tuš ročico in polnilno /odlivno prelivno gar. za polnjenje kadi jednoručna arm. s tuš ručicom i priljev/odljev preljevnom garnituro za punjenje kada	3838987 506287	603,00
	RAINDROP	enoročna armatura s tuš ročico in izlivom / jednoručna armatura s tuš ručicom i izljevom	3838987 726500	590,00
	UP&DOWN, WHITE	prelivna garnitura s sifonom, bela prejevnna garnitura sa sifonom, bijela	3838987 922759	62,00
	PAL 650	prelivna garnitura s sifonom prejevnna garnitura sa sifonom	3838987 746270	55,00
	2x PKK 800	podnožje kopalne kadi za vgradnjo podnožje kupaonske kade za ugradnju cena za 1 kos / cijena za 1 komad	2x 3838987 795100	2x 47,00
	HEADREST SOFT	vzglavnik naslon za glavu	3838987 593942	79,00
	HEADREST COAST		3838987 593928	103,00
	Zidni montažni set Zidni montažni set	za kopalne in tuš kadi za vgradnjo za kupaonske i tuš kade za ugradnju	3838987 704362	11,00
	Suhomontažna zaključna letev Završna letva u sistemu suhe montaže	karton 25 kosov / karton 25 komada (Cena za kos / Cijena na komad 30,60 EUR)	3838987 903116	765,00
	Servisno prezračevalni pokrov z rešetko Servisno ventilacijski pokrov s rešetkom	za masažne kadi za vgradnjo (45x45 cm) za masažne kade za ugradnju (45x45 cm)	3838987 534808	90,00
	ANTI-SLIP PREMAZ	protizdrsni premaz za kopalne kadi protiv klizni premaz za kupaonske kade (min. kol. 10 kos)		67,00
	Specialno čistoilo KOLPA SAN Specialno sredstvo za čišćenje	karton 20 kosov / karton 20 komada (Cena za kos / Cijena na komad 6,20 EUR)	3838987 747291	124,00
	Specialno čistoilo ECO SAN Specialno sredstvo za čišćenje	karton 20 kosov / karton 20 komada (Cena za kos / Cijena na komad 5,40 EUR)	3838987 572220	108,00
	Čistilo za masažne sisteme Sredstvo za čišćenje masažnih sistema	karton 10 kosov / karton 10 komada (Cena za kos / Cijena na komad 7,80 EUR)	3838987 747277	78,00









Kopalne in masažne kadi

Kade za kupanje i masažne kade

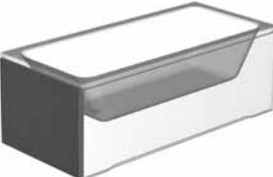
Program:

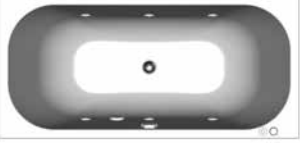
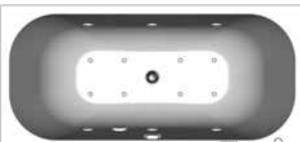















kolpa·san®

Model	Naziv in dimenzija izdelka Naziv i dimenzije produkta	Opis Opis	EAN koda EAN koda	Cena EUR Cijena EUR
Pandora bathtub 180x85				
	Pandora bathtub 180x85	kopalna kad za vgradnjo kada za ugradnju	3838987 593133	321,00
	A 180/63	dolga obloga duga obloga	3838987 565215	73,00
	A 85/63	kratka obloga kratka obloga	3838987 565475	49,00
	CM 180-200	podnožje kopalne kadi za oblogo podnožje kupaonske kade za oblogu	3838987 573012	119,00
	Vodni masažni sistem I. Vodeni masažni sistem I. PNEVMATSKI Pandora bathtub 180x85	z oblogo s oblogom z oblogo + mikrošobe s oblogom + mikromlaznice	3838987 576594 3838987 576600	1.356,00 1.894,00
	Kombinirani (vodni in zračni) masažni sistem / Kombinirani (vodeni i zračni) masažni sistem ELEKTRONSKI Pandora bathtub 180x85	z oblogo s oblogom z oblogo + mikrošobe s oblogom + mikromlaznice	3838987 577034 3838987 577058	2.573,00 3.110,00
Vgradnja mikrošob v kad Ugradnja mikromlaznica u kadu Pandora 180x85				
	Prikaz vgradnje mikrošob Prikaz ugradnje mikromlaznica Pandora bathtub 180x85			

Kopalne in masažne kadi

Kade za kupanje i masažne kade

Program:kolpa·san[®]







Model	Naziv in dimenzija izdelka Naziv i dimenzije produkta	Opis Opis	EAN koda EAN koda	Cena EUR Cijena EUR
Dodatki za / Dodaci za Pandora bathtub 180x85				
	WATERFALL 	enoročna armatura s tuš ročico in izlivom / jednoručna armatura s tuš ručicom i izljevom	3838987 734543	562,00
	GEYSER 	enoročna arm. s tuš ročico in polnilno /odlivno prelivno gar. za polnjenje kadi jednoručna arm. s tuš ručicom i priljev/odljev prelivnom garnituroom za punjenje kada	3838987 506287	603,00
	RAINDROP 	enoročna armatura s tuš ročico in izlivom / jednoručna armatura s tuš ručicom i izljevom	3838987 726500	590,00
	UP&DOWN, WHITE	prelivna garnitura s sifonom, bela prelivna garnitura sa sifonom, bijela	3838987 922759	62,00
	PAL 650	prelivna garnitura s sifonom prelivna garnitura sa sifonom	3838987 746270	55,00
	HEADREST SOFT	vzglavnik naslon za glavu	3838987 593942	79,00
	HEADREST COAST		3838987 593928	103,00
	PKK 501	podnožje kopalne kadi za vgradnjo podnožje kupaonske kade za ugradnju	3838987 764878	28,00
	Zidni montažni set Zidni montažni set	za kopalne in tuš kadi za vgradnjo za kupaonske i tuš kade za ugradnju	3838987 704362	11,00
	Montažni set za oblogo /magnet Montažni set za oblogu / magnet	za kopalne kadi (v primeru dodatne kratke obloge) / za kupaonske kade (u primeru dodatne kratke obloge)	3838987 590750	28,00
	Suhomontažna zaključna letva Završna letva u sistemu suhe montaže	karton 25 kosov / karton 25 komada (Cena za kos / Cijena na komad 30,60 EUR)	3838987 903116	765,00
	Chromoterapia (CTL) Chromoterapia (CTL)	2 LED lučki s samostojno tipkovnico 2 LED svjetla sa samostalnom tipkovnicom		382,00
	Servisno prezačevalni pokrov z rešetko Servisno ventilacijski pokrov s rešetkom	za masažne kadi za vgradnjo (45x45 cm) za masažne kade za ugradnju (45x45 cm)	3838987 534808	90,00
	ANTI-SLIP PREMAZ	protizdrsni premaz za kopalne kadi protiv klizni premaz za kupaonske kade (min. kol. 10 kos)		67,00
	Specialno čištilo KOLPA SAN Specialno sredstvo za čišćenje	karton 20 kosov / karton 20 komada (Cena za kos / Cijena na komad 6,20 EUR)	3838987 747291	124,00
	Specialno čištilo ECO SAN Specialno sredstvo za čišćenje	karton 20 kosov / karton 20 komada (Cena za kos / Cijena na komad 5,40 EUR)	3838987 572220	108,00
	Čištilo za masažne sisteme Sredstvo za čišćenje masažnih sistema	karton 10 kosov / karton 10 komada (Cena za kos / Cijena na komad 7,80 EUR)	3838987 747277	78,00



Kopalne in masažne kadi

Kade za kupanje i masažne kade

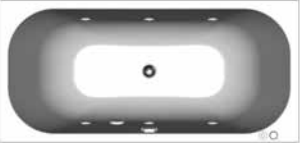
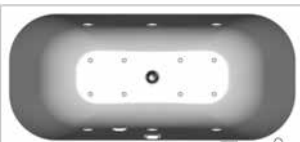















Program:kolpa·san[®]

Model	Naziv in dimenzija izdelka Naziv i dimenzije produkta	Opis Opis	EAN koda EAN koda	Cena EUR Cijena EUR
Pandora bathtub 170x75				
	Pandora bathtub 170x75	kopalna kad za vgradnjo kada za ugradnju	3838987 593119	310,00
	A 170/63	dolga obloga duga obloga	3838987 565376	73,00
	A 75/63	kratka obloga kratka obloga	3838987 565369	45,00
	CM 160-170	podnožje kopalne kadi za oblogo podnožje kupaonske kade za oblogu	3838987 573005	119,00
	Vodni masažni sistem I. Vodeni masažni sistem I. PNEVMATSKI Pandora bathtub 170x75	z oblogo s oblogom z oblogo + mikrošobe s oblogom + mikromlaznice	3838987 576556 3838987 576563	1.347,00 1.884,00
	Kombinirani (vodni in zračni) masažni sistem / Kombinirani (vodeni i zračni) masažni sistem ELEKTRONSKI Pandora bathtub 170x75	z oblogo s oblogom z oblogo + mikrošobe s oblogom + mikromlaznice	3838987 577010 3838987 593195	2.563,00 3.101,00
Vgradnja mikrošob v kad Ugradnja mikromlaznica u kadu Pandora 170x75				
	Prikaz vgradnje mikrošob Prikaz ugradnje mikromlaznica Pandora bathtub 170x75			

Kopalne in masažne kadi
Kade za kupanje i masažne kade

Program:

kolpa·san
BY KOLPA











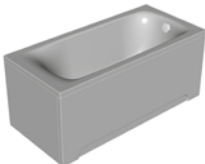



Model	Naziv in dimenzija izdelka Naziv i dimenzije produkta	Opis Opis	EAN koda EAN koda	Cena EUR Cijena EUR
Dodatki za / Dodaci za Pandora bathtub 170x75				
	WATERFALL 	enoročna armatura s tuš ročico in izlivom / jednoručna armatura s tuš ručicom i izljevom	3838987 734543	562,00
	GEYSER 	enoročna arm. s tuš ročico in polnilno /odlivno prelivno gar. za polnjenje kadi jednoručna arm. s tuš ručicom i priljev/odljev preljevnom garnituroom za punjenje kada	3838987 506287	603,00
	RAINDROP 	enoročna armatura s tuš ročico in izlivom / jednoručna armatura s tuš ručicom i izljevom	3838987 726500	590,00
	UP&DOWN, WHITE	prelivna garnitura s sifonom, bela preljevna garnitura sa sifonom, bijela	3838987 922759	62,00
	PAL 650	prelivna garnitura s sifonom preljevna garnitura sa sifonom	3838987 746270	55,00
	HEADREST SOFT	vzglavnik naslon za glavu	3838987 593942	79,00
	HEADREST COAST		3838987 593928	103,00
	PKK 501	podnožje kopalne kadi za vgradnjo podnožje kupaonske kade za ugradnju	3838987 764878	28,00
	Zidni montažni set Zidni montažni set	za kopalne in tuš kadi za vgradnjo za kupaonske i tuš kade za ugradnju	3838987 704362	11,00
	Montažni set za oblogo /magnet Montažni set za oblogo / magnet	za kopalne kadi (v primeru dodatne kratke obloge) / za kupaonske kade (u primeru dodatne kratke obloge)	3838987 590750	28,00
	Suhomontažna zaključna letva Završna letva u sistemu suhe montaže	karton 25 kosov / karton 25 komada (Cena za kos / Cijena na komad 30,60 EUR)	3838987 903116	765,00
	Chromoterapia (CTL) Chromoterapia (CTL)	2 LED lučki s samostojno tipkovnico 2 LED svjetla sa samostalnom tipkovnicom		382,00
	Servisno prezačevalni pokrov z rešetko Servisno ventilacijski pokrov s rešetkom	za masažne kadi za vgradnjo (45x45 cm) za masažne kade za ugradnju (45x45 cm)	3838987 534808	90,00
	ANTI-SLIP PREMAZ	protizdrsni premaz za kopalne kadi protiv klizni premaz za kupaonske kade (min. kol. 10 kos)		67,00
	Specijalno čištilo KOLPA SAN Specijalno sredstvo za čišćenje	karton 20 kosov / karton 20 komada (Cena za kos / Cijena na komad 6,20 EUR)	3838987 747291	124,00
	Specijalno čištilo ECO SAN Specijalno sredstvo za čišćenje	karton 20 kosov / karton 20 komada (Cena za kos / Cijena na komad 5,40 EUR)	3838987 572220	108,00
	Čištilo za masažne sisteme Sredstvo za čišćenje masažnih sistema	karton 10 kosov / karton 10 komada (Cena za kos / Cijena na komad 7,80 EUR)	3838987 747277	78,00



Kopalne in masažne kadi
Kade za kupanje i masažne kade

Program:

kolpa·san
BY KOLPA













Model	Naziv in dimenzija izdelka Naziv i dimenzije produkta	Opis Opis	EAN koda EAN koda	Cena EUR Cijena EUR
Evelin bathtub 170x75				
	Evelin bathtub 170x75 KOS/KOMAD na paleti = 15	kopalna kad za vgradnjo kada za ugradnju	3838987 593072	167,00
	Obloga s podnožjem Evelin / Tamia 170x75	kratka in dolga obloga s podnožjem kratka i duga obloga sa podnožjem	3838987 571285	207,00
	Vodni masažni sistem I. Vodeni masažni sistem I. PNEVMATSKI Evelin bathtub 170x75	z oblogo / s oblogom	3838987 576488	931,00
Dodatki za / Dodaci za Evelin bathtub 170x75				
	UP&DOWN, WHITE	prelivna garnitura s sifonom, bela preljevna garnitura sa sifonom, bijela	3838987 922759	62,00
	PAL 650	prelivna garnitura s sifonom preljevna garnitura sa sifonom	3838987 746270	55,00
	HEADREST COAST	vzglavnik naslon za glavu	3838987 593928	103,00
	SKK	sedež za kopalno kad sjedalo za kupaonsku kadu	3838987 950943	101,00
	PKK 501	podnožje kopalne kadi za vgradnjo podnožje kupaonske kade za ugradnju	3838987 764878	28,00
	Zidni montažni set Zidni montažni set	za kopalne in tuš kadi za vgradnjo za kupaonske i tuš kade za ugradnju	3838987 704362	11,00
	Montažni set za oblogo Montažni set za oblogu	za kopalno kad Tamia (v primeru dodatne kratke obloge) / za kupaonsku kadu Tamia (u primeru dodatne kratke obloge)	3838987 994787	28,00
	Suhomontažna zaključna letva Završna letva u sistemu suhe montaže	karton 25 kosov / karton 25 komada (Cena za kos / Cijena na komad 30,60 EUR)	3838987 903116	765,00
	Servisno prezračevalni pokrov z rešetko Servisno ventilacijski pokrov s rešetkom	za masažne kadi za vgradnjo (45x45 cm) za masažne kade za ugradnju (45x45 cm)	3838987 534808	90,00
	ANTI-SLIP PREMAZ	protizdrsni premaz za kopalne kadi protiv klizni premaz za kupaonske kade (min. kol. 10 kos)		67,00
	Specialno čistilo KOLPA SAN Specialno sredstvo za čišćenje	karton 20 kosov / karton 20 komada (Cena za kos / Cijena na komad 6,20 EUR)	3838987 747291	124,00
	Specialno čistilo ECO SAN Specialno sredstvo za čišćenje	karton 20 kosov / karton 20 komada (Cena za kos / Cijena na komad 5,40 EUR)	3838987 572220	108,00
	Čistilo za masažne sisteme Sredstvo za čišćenje masažnih sistema	karton 10 kosov / karton 10 komada (Cena za kos / Cijena na komad 7,80 EUR)	3838987 747277	78,00

Kopalne in masažne kadi

Kade za kupanje i masažne kade

Program:

kolpa·san
BY KOLPA

Model	Naziv in dimenzija izdelka Naziv i dimenzije produkta	Opis Opis	EAN koda EAN koda	Cena EUR Cijena EUR
Evelin bathtub 170x70, 160x70, 150x70, 140x70				
	Evelin bathtub 170x70	kopalna kad za vgradnjo kada za ugradnju	3838987 593348	167,00
	Evelin bathtub 160x70		3838987 593355	167,00
	Evelin bathtub 150x70		3838987 593362	167,00
	Evelin bathtub 140x70		3838987 593379	159,00
	KOS/KOMAD na paleti = 15			
	Obloga s podnožjem Evelin / Tamia 170x70	kratka in dolga obloga s podnožjem kratka i duga obloga sa podnožjem	3838987 571278	207,00
	Obloga s podnožjem Evelin / Tamia 160x70		3838987 571261	207,00
	Obloga s podnožjem Evelin / Tamia 150x70		3838987 572985	207,00
	Obloga s podnožjem Evelin / Tamia 140x70		3838987 572978	207,00
Dodatki za / Dodaci za Evelin bathtub				
	UP&DOWN, WHITE	prelivna garnitura s sifonom, bela preljevna garnitura sa sifonom, bijela	3838987 922759	62,00
	PAL 650	prelivna garnitura s sifonom preljevna garnitura sa sifonom	3838987 746270	55,00
	HEADREST COAST	vzglavnik naslon za glavu	3838987 593928	103,00
	SKK	sedež za kopalno kad sjedalo za kupaonsku kadu	3838987 950943	101,00
	PKK 501	podnožje kopalne kadi za vgradnjo podnožje kupaonske kade za ugradnju	3838987 764878	28,00
	Zidni montažni set Zidni montažni set	za kopalne in tuš kadi za vgradnjo za kupaonske i tuš kade za ugradnju	3838987 704362	11,00
	Montažni set za oblogu Montažni set za oblogu	za kopalno kad Tamia (v primeru dodatne kratke obloge) / za kupaonsku kadu Tamia (u primeru dodatne kratke obloge)	3838987 994787	28,00
	Suhomontažna zaključna letva Završna letva u sistemu suhe montaže	karton 25 kosov / karton 25 komada (Cena za kos / Cijena na komad 30,60 EUR)	3838987 903116	765,00
	Servisno prezračevalni pokrov z rešetko Servisno ventilacijski pokrov s rešetkom	za masažne kadi za vgradnjo (45x45 cm) za masažne kade za ugradnju (45x45 cm)	3838987 534808	90,00
	ANTI-SLIP PREMAZ	protizdrsni premaz za kopalne kadi protiv klizni premaz za kupaonske kade (min. kol. 10 kos)		67,00
	Specialno čistilo KOLPA SAN Specialno sredstvo za čiščenje	karton 20 kosov / karton 20 komada (Cena za kos / Cijena na komad 6,20 EUR)	3838987 747291	124,00
	Specialno čistilo ECO SAN Specialno sredstvo za čiščenje	karton 20 kosov / karton 20 komada (Cena za kos / Cijena na komad 5,40 EUR)	3838987 572220	108,00



Kopalne in masažne kadi
Kade za kupanje i masažne kade

Program:











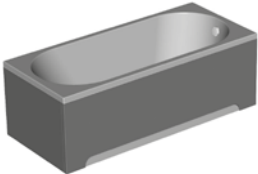
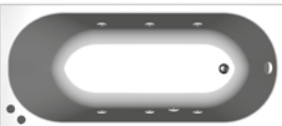



kolpa·san
BY KOLPA

Model	Naziv in dimenzija izdelka Naziv i dimenzije produkta	Opis Opis	EAN koda EAN koda	Cena EUR Cijena EUR
Tamia 180x80				
	Tamia 180x80 KOS/KOMAD na paleti = 15	kopalna kad za vgradnjo kada za ugradnju	3838987 539643	218,00
	Obloga s podnožjem Tamia 180x80	kratka in dolga obloga s podnožjem kratka i duga obloga sa podnožjem	3838987 571292	238,00
	Vodni masažni sistem I. Vodeni masažni sistem I. PNEVMATSKI Tamia 180x80	z oblogo / s oblogom	3838987 927556	1.145,00
Dodatki za / Dodaci za Tamia 180x80				
	UP&DOWN, WHITE	prelivna garnitura s sifonom, bela preljevna garnitura sa sifonom, bijela	3838987 922759	62,00
	PAL 450	prelivna garnitura s sifonom preljevna garnitura sa sifonom	3838987 746263	40,00
	HEADREST SOFT HEADREST COAST	vzglavnik naslon za glavu	3838987 593942 3838987 593928	79,00 103,00
	PKK 501	podnožje kopalne kadi za vgradnjo podnožje kupaonske kade za ugradnju	3838987 764878	28,00
	Zidni montažni set Zidni montažni set	za kopalne in tuš kadi za vgradnjo za kupaonske i tuš kade za ugradnju	3838987 704362	11,00
	Montažni set za oblogo Montažni set za oblogo	za kopalno kad Tamia (v primeru dodatne kratke obloge) / za kupaonsku kadu Tamia (u primeru dodatne kratke obloge)	3838987 994787	28,00
	Suhomontažna zaključna letva Završna letva u sistemu suhe montaže	karton 25 kosov / karton 25 komada (Cena za kos / Cijena na komad 30,60 EUR)	3838987 903116	765,00
	Servisno prezračevalni pokrov z rešetko Servisno ventilacijski pokrov s rešetkom	za masažne kadi za vgradnjo (45x45 cm) za masažne kade za ugradnju (45x45 cm)	3838987 534808	90,00
	ANTI-SLIP PREMAZ	protizdrsni premaz za kopalne kadi protiv klizni premaz za kupaonske kade (min. kol. 10 kos)		67,00
	Specialno čištilo KOLPA SAN Specialno sredstvo za čiščenje Specialno čištilo ECO SAN Specialno sredstvo za čiščenje Čištilo za masažne sisteme Sredstvo za čiščenje masažnih sistema	karton 20 kosov / karton 20 komada (Cena za kos / Cijena na komad 6,20 EUR) karton 20 kosov / karton 20 komada (Cena za kos / Cijena na komad 5,40 EUR) karton 10 kosov / karton 10 komada (Cena za kos / Cijena na komad 7,80 EUR)	3838987 747291 3838987 572220 3838987 747277	124,00 108,00 78,00

Kopalne in masažne kadi
Kade za kupanje i masažne kade

Program:

kolpa·san
BY KOLPA

Model	Naziv in dimenzija izdelka Naziv i dimenzije produkta	Opis Opis	EAN koda EAN koda	Cena EUR Cijena EUR
Tamia 170x75				
	Tamia 170x75 KOS/KOMAD na paleti = 15	kopalna kad za vgradnjo kada za ugradnju	3838987 749981	169,00
	Obloga s podnožjem Evelin / Tamia 170x75	kratka in dolga obloga s podnožjem kratka i duga obloga sa podnožjem	3838987 571285	207,00
	Vodni masažni sistem I. Vodeni masažni sistem I. PNEVMATSKI Tamia 170x75	z oblogo / s oblogom	3838987 590644	934,00
Dodatki za / Dodaci za Tamia 170x75				
	UP&DOWN, WHITE	prelivna garnitura s sifonom, bela preljevna garnitura sa sifonom, bijela	3838987 922759	62,00
	PAL 450	prelivna garnitura s sifonom preljevna garnitura sa sifonom	3838987 746263	40,00
	HEADREST SOFT HEADREST COAST	vzglavnik naslon za glavu	3838987 593942 3838987 593928	79,00 103,00
	SKK	sedež za kopalno kad sjedalo za kupaonsku kadu	3838987 950943	101,00
	PKK 501	podnožje kopalne kadi za vgradnjo podnožje kupaonske kade za ugradnju	3838987 764878	28,00
	Zidni montažni set Zidni montažni set	za kopalne in tuš kadi za vgradnjo za kupaonske i tuš kade za ugradnju	3838987 704362	11,00
	Montažni set za oblogo Montažni set za oblogu	za kopalno kad Tamia (v primeru dodatne kratke obloge) / za kupaonsku kadu Tamia (u primeru dodatne kratke obloge)	3838987 994787	28,00
	Suhomontažna zaključna letev Završna letva u sistemu suhe montaže	karton 25 kosov / karton 25 komada (Cena za kos / Cijena na komad 30,60 EUR)	3838987 903116	765,00
	Servisno prezračevalni pokrov z rešetko Servisno ventilacijski pokrov s rešetkom	za masažne kadi za vgradnjo (45x45 cm) za masažne kade za ugradnju (45x45 cm)	3838987 534808	90,00
	ANTI-SLIP PREMAZ	protizdrsni premaz za kopalne kadi protiv klizni premaz za kupaonske kade (min. kol. 10 kos)		67,00
	Specialno čistoilo KOLPA SAN Specialno sredstvo za čišćenje	karton 20 kosov / karton 20 komada (Cena za kos / Cijena na komad 6,20 EUR)	3838987 747291	124,00
	Specialno čistoilo ECO SAN Specialno sredstvo za čišćenje	karton 20 kosov / karton 20 komada (Cena za kos / Cijena na komad 5,40 EUR)	3838987 572220	108,00
	Čistilo za masažne sisteme Sredstvo za čišćenje masažnih sistema	karton 10 kosov / karton 10 komada (Cena za kos / Cijena na komad 7,80 EUR)	3838987 747277	78,00











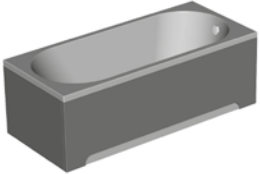

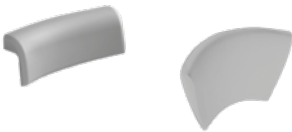
Kopalne in masažne kadi

Kade za kupanje i masažne kade

Program:

kolpa·san
BY KOLPA













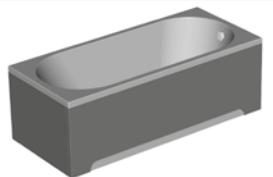

Model	Naziv in dimenzija izdelka Naziv i dimenzije produkta	Opis Opis	EAN koda EAN koda	Cena EUR Cijena EUR
Tamia 170x70, 160x70, 150x70				
	Tamia 170x70	kopalna kad za vgradnjo kada za ugradnju	3838987 992233	169,00
	Tamia 160x70		3838987 752905	169,00
	Tamia 150x70		3838987 755319	169,00
<small>KOS/KOMAD na paleti = 15</small>				
	Obloga s podnožjem Evelin / Tamia 170x70	kratka in dolga obloga s podnožjem kratka i duga obloga sa podnožjem	3838987 571278	207,00
	Obloga s podnožjem Evelin / Tamia 160x70		3838987 571261	207,00
	Obloga s podnožjem Tamia 150x70		3838987 572985	207,00
Dodatki za / Dodaci za Tamia				
	UP&DOWN, WHITE	prelivna garnitura s sifonom, bela preljevna garnitura sa sifonom, bijela	3838987 922759	62,00
	PAL 450	prelivna garnitura s sifonom preljevna garnitura sa sifonom	3838987 746263	40,00
	HEADREST SOFT	vzglavnik naslon za glavu	3838987 593942	79,00
	HEADREST COAST	vzglavnik naslon za glavu	3838987 593928	103,00
	SKK	sedež za kopalno kad sjedalo za kupaonsku kadu	3838987 950943	101,00
	PKK 501	podnožje kopalne kadi za vgradnjo podnožje kupaonske kade za ugradnju	3838987 764878	28,00
	Zidni montažni set Zidni montažni set	za kopalne in tuš kadi za vgradnjo za kupaonske i tuš kade za ugradnju	3838987 704362	11,00
	Montažni set za oblogu Montažni set za oblogu	za kopalno kad Tamia (v primeru dodatne kratke obloge) / za kupaonsku kadu Tamia (u primeru dodatne kratke obloge)	3838987 994787	28,00
	Suhomontažna zaključna letva Završna letva u sistemu suhe montaže	karton 25 kosov / karton 25 komada (Cena za kos / Cijena na komad 30,60 EUR)	3838987 903116	765,00
	Servisno prezračevalni pokrov z rešetkom Servisno ventilacijski pokrov s rešetkom	za kopalne kadi za vgradnjo (45x45 cm) za kupaonske kade za ugradnju (45x45 cm)	3838987 534808	90,00
	ANTI-SLIP PREMAZ	protizdrsni premaz za kopalne kadi protiv klizni premaz za kupaonske kade (min. kol. 10 kos)		67,00
	Specialno čistilo KOLPA SAN Specialno sredstvo za čiščenje	karton 20 kosov / karton 20 komada (Cena za kos / Cijena na komad 6,20 EUR)	3838987 747291	124,00
	Specialno čistilo ECO SAN Specialno sredstvo za čiščenje	karton 20 kosov / karton 20 komada (Cena za kos / Cijena na komad 5,40 EUR)	3838987 572220	108,00
114	www.kolpasan.si	www.kolpasan.hr		

Kopalne in masažne kadi













Kade za kupanje i masažne kade

Program:

kolpa·san
BY KOLPA

Model	Naziv in dimenzija izdelka Naziv i dimenzije produkta	Opis Opis	EAN koda EAN koda	Cena EUR Cijena EUR
Tamia 140x70, 140x70/S				
	Tamia 140x70 KOS/KOMAD na paleti = 15	kopalna kad za vgradnjo kada za ugradnju	3838987 752912	162,00
	Tamia 140x70/S	kopalna kad za vgradnjo s sedežem kada za ugradnju sa sjedalom	3838987 752943	162,00
	Obloga s podnožjem Tamia 140x70 in Tamia 140x70/S	kratka in dolga obloga s podnožjem kratka i duga obloga sa podnožjem	3838987 572978	207,00
Dodatki za / Dodaci za Tamia 140x70				
	UP&DOWN, WHITE	prelivna garnitura s sifonom, bela preljevna garnitura sa sifonom, bijela	3838987 922759	62,00
	PAL 450	prelivna garnitura s sifonom preljevna garnitura sa sifonom	3838987 746263	40,00
	HEADREST SOFT	vzglavnik naslon za glavu	3838987 593942	79,00
	HEADREST HEADREST COAST	vzglavnik naslon za glavu	3838987 593928	103,00
	SKK	sedež za kopalno kad sjedalo za kupaonsku kadu	3838987 950943	101,00
	PKK 501	podnožje kopalne kadi za vgradnjo podnožje kupaonske kade za ugradnju	3838987 764878	28,00
	Zidni montažni set Zidni montažni set	za kopalne in tuš kadi za vgradnjo za kupaonske i tuš kade za ugradnju	3838987 704362	11,00
	Montažni set za oblogu Montažni set za oblogu	za kopalno kad Tamia (v primeru dodatne kratke obloge) / za kupaonsku kadu Tamia (u primeru dodatne kratke obloge)	3838987 994787	28,00
	Suhomontažna zaključna letva Završna letva u sistemu suhe montaže	karton 25 kosov / karton 25 komada (Cena za kos / Cijena na komad 30,60 EUR)	3838987 903116	765,00
	Servisno prezračevalni pokrov z rešetkom Servisno ventilacijski pokrov s rešetkom	za kopalne kadi za vgradnjo (45x45 cm) za kupaonske kade za ugradnju (45x45 cm)	3838987 534808	90,00
	ANTI-SLIP PREMAZ	protizdrsni premaz za kopalne kadi protiv klizni premaz za kupaonske kade (min. kol. 10 kos)		67,00
	Specialno čištilo KOLPA SAN Specialno sredstvo za čiščenje Specialno čištilo ECO SAN Specialno sredstvo za čiščenje	karton 20 kosov / karton 20 komada (Cena za kos / Cijena na komad 6,20 EUR) karton 20 kosov / karton 20 komada (Cena za kos / Cijena na komad 5,40 EUR)	3838987 747291 3838987 572220	124,00 108,00
www.kolpasan.hr		www.kolpasan.si		115













Kopalne in masažne kadi Kade za kupanje i masažne kade		Program: kolpa·san®		
Model	Naziv in dimenzija izdelka Naziv i dimenzije produkta	Opis Opis	EAN koda EAN koda	Cena EUR Cijena EUR
Figaro 170x75, 160x80, 150x70				
	Figaro 170x75	kopalna kad za vgradnjo kada za ugradnju	3838987 741435	297,00
	Figaro 160x80	kopalna kad za vgradnjo kada za ugradnju	3838987 596097	297,00
	Figaro 150x70	kopalna kad za vgradnjo kada za ugradnju	3838987 757634	271,00
Dodatki za / Dodaci za Figaro 170x75				
	UP&DOWN, WHITE	prelivna garnitura s sifonom, bela prelivna garnitura sa sifonom, bijela	3838987 922759	62,00
	PAL 450	prelivna garnitura s sifonom prelivna garnitura sa sifonom	3838987 746263	40,00
	HEADREST COAST	vzglavnik naslon za glavu	3838987 593928	103,00
	SKK	sedež za kopalno kad sjedalo za kupaonsku kadu	3838987 950943	101,00
	PKK 501	podnožje kopalne kadi za vgradnjo podnožje kupaonske kade za ugradnju	3838987 764878	28,00
	Zidni montažni set Zidni montažni set	za kopalne in tuš kadi za vgradnjo za kupaonske i tuš kade za ugradnju	3838987 704362	11,00
	Suhomontažna zaključna letev Završna letva u sistemu suhe montaže	karton 25 kosov / karton 25 komada (Cena za kos / Cijena na komad 30,60 EUR)	3838987 903116	765,00
	Servisno prezračevalni pokrov z rešetko Servisno ventilacijski pokrov s rešetkom	za kopalne kadi za vgradnjo (45x45 cm) za kupaonske kade za ugradnju (45x45 cm)	3838987 534808	90,00
	ANTI-SLIP PREMAZ	protizdrnsni premaz za kopalne kadi protiv klizni premaz za kupaonske kade (min. kol. 10 kos)		67,00
	Specialno čistilo KOLPA SAN Specialno sredstvo za čiščenje	karton 20 kosov / karton 20 komada (Cena za kos / Cijena na komad 6,20 EUR)	3838987 747291	124,00
	Specialno čistilo ECO SAN Specialno sredstvo za čiščenje	karton 20 kosov / karton 20 komada (Cena za kos / Cijena na komad 5,40 EUR)	3838987 572220	108,00

Kopalne in masažne kadi

Kade za kupanje i masažne kade

Program:**kolpa·san**
by KOLPA



Model	Naziv in dimenzija izdelka Naziv i dimenzije produkta	Opis Opis	EAN koda EAN koda	Cena EUR Cijena EUR
Mini 100x70				
	Mini 100x70	kopalna kad za vgradnjo kada za ugradnju	3838987 945543	204,00
Dodatki za / Dodaci za Mini 100x70				
	UP&DOWN, WHITE	prelivna garnitura s sifonom, bela preljevna garnitura sa sifonom, bijela	3838987 922759	62,00
	PAL 450	prelivna garnitura s sifonom preljevna garnitura sa sifonom	3838987 746263	40,00
	HEADREST COAST	vzglavnik naslon za glavu	3838987 593928	103,00
	SKK	sedež za kopalno kad sjedalo za kupaonsku kadu	3838987 950943	101,00
	PKK 501	podnožje kopalne kadi za vgradnjo podnožje kupaonske kade za ugradnju	3838987 764878	28,00
	Zidni montažni set Zidni montažni set	za kopalne in tuš kadi za vgradnjo za kupaonske i tuš kade za ugradnju	3838987 704362	11,00
	Suhomontažna zaključna letev Završna letva u sistemu suhe montaže	karton 25 kosov / karton 25 komada (Cena za kos / Cijena na komad 30,60 EUR)	3838987 903116	765,00
	Servisno prezračevalni pokrov z rešetko Servisno ventilacijski pokrov s rešetkom	za kopalne kadi za vgradnjo (45x45 cm) za kupaonske kade za ugradnju (45x45 cm)	3838987 534808	90,00
	ANTI-SLIP PREMAZ	protizdrsni premaz za kopalne kadi protiv klizni premaz za kupaonske kade (min. kol. 10 kos)		67,00
	Specialno čistilo KOLPA SAN Specialno sredstvo za čiščenje	karton 20 kosov / karton 20 komada (Cena za kos / Cijena na komad 6,20 EUR)	3838987 747291	124,00
	Specialno čistilo ECO SAN Specialno sredstvo za čiščenje	karton 20 kosov / karton 20 komada (Cena za kos / Cijena na komad 5,40 EUR)	3838987 572220	108,00



Armature za kopalne kadi

Armature za kupaonske kade

Program:**kolpa·san**
BY KOLPA

Model	Naziv in dimenzija izdelka Naziv i dimenzije produkta	Opis Opis	EAN koda EAN koda	Cena EUR Cijena EUR
WATERFALL				
	WATERFALL	<p>enoročna armatura s tuš ročico in izlivom / jednoručna armatura s tuš ručicom i izlivom</p> <p>za kadi z oblogo / za kade s oblogom,</p> <p>pri kadeh brez obloge je obvezna ustrezno velika servisna odprtina kod kada bez obloge obavezni je dovoljno velik servisni otvor</p>	3838987 734543	562,00
GEYSER				
	GEYSER	<p>enoročna arm. s tuš ročico in polnilno /odlivno prelivno gar. za polnjenje kadi jednoručna arm. s tuš ručicom i priljev/odljev prelivnom garniturom za punjenje kada</p> <p>za kadi z oblogo / za kade s oblogom,</p> <p>pri kadeh brez obloge je obvezna ustrezno velika servisna odprtina kod kada bez obloge obavezni je dovoljno velik servisni otvor</p>	3838987 506287	603,00
RAINDROP				
	RAINDROP	<p>enoročna armatura s tuš ročico in izlivom / jednoručna armatura s tuš ručicom i izlivom</p> <p>za kadi z oblogo / za kade s oblogom,</p> <p>pri kadeh brez obloge je obvezna ustrezno velika servisna odprtina kod kada bez obloge obavezni je dovoljno velik servisni otvor</p>	3838987 726500	590,00



Masažne kabine, parne savne in masažni stebri

Masažne kabine, parne saune i masažni stupovi

Slike so simbolične. Pravilna rasporeditev elementov je v TEHNIČNEM KATALOGU na www.kolpasan.si
Slike su simbolične. Tačan raspored elemenata je u TEHNIČKOM KATALOGU na www.kolpasan.hr





2



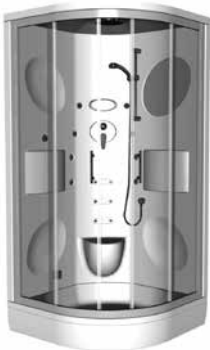

leti garancije
godine jamstva

Masažne kabine, stebri

Masažne kabine, stupovi

Program:**kolpa·san**
BY KOLPA

Model	Naziv in dimenzija izdelka Naziv i dimenzije produkta	Opis Opis	EAN koda EAN koda	Cena EUR Cijena EUR
Melba 100				
	Melba M3 100x100	masažna kabina s parno savno (kaljeno prozorno steklo) masažna kabina s parnom saunom (kaljeno prozorno staklo)	3838987 932581	2.800,00
	Melba M1 100x100	parna savna - s stropno prho in ročnim tušem (kaljeno prozorno steklo) parna sauna - stropni tuš i tuš ručka (kaljeno prozorno staklo)	3838987 593904	2.534,00
	Melba SIMPLE 100x100	tuš kabina - s stropno prho in ročnim tušem (kaljeno prozorno steklo) tuš kabina - stropni tuš i tuš ručka (kaljeno prozorno staklo)	3838987 593898	1.871,00
Aria QUAT				
	Aria QUAT A3 90x90	masažna kabina s parno savno (kaljeno prozorno steklo) masažna kabina s parnom saunom (kaljeno prozorno staklo)	3838987 731832	2.597,00
	Aria QUAT A0 90x90	masažna kabina (kaljeno prozorno steklo) masažna kabina (kaljeno prozorno staklo)	3838987 799047	1.627,00
	Aria QUAT SIMPLE 90x90	tuš kabina - s stropno prho in ročnim tušem (kaljeno prozorno steklo) tuš kabina - stropni tuš i tuš ručka (kaljeno prozorno staklo)	3838987 500032	1.627,00
Sky 1600 3f				
	Sky 1600 3f - white 109	prilagodljiv masažni steber za tuš kabino, Kerrock (za tuš kadi širine 80-90 cm) fleksibilni masažni stup za tuš kabino, od Kerrocka (za tuš kade širine 80-90 cm)	3838987 593010	1.207,00
	Sky 1600 3f - andesite 9252		3838987 927686	1.207,00
	WO Sky 120 - UNI SBR/1 Calypso	tuš stena, silver brill – 8 mm steklo tuš stijenka, silver brill	3838987 518327	306,00
	WO Sky 140 - UNI SBR/1 Calypso		3838987 518341	340,00
	WO Sky 120 - UNI B/1 Calypso	tuš stena, črni profil – 8 mm steklo tuš stijenka, crni profil	3838987 518310	321,00
	WO Sky 140 - UNI B/1 Calypso		3838987 518334	355,00
Dodatki / Dodaci				
	Specialno čistilo KOLPA SAN Specialno sredstvo za čiščenje	krt = 20 x 0,5 l (Cena za kos / Cijena na komad 6,20 EUR)	3838987 747291	124,00
	Specialno čistilo ECO SAN Specialno sredstvo	krt = 20 x 0,5 l (Cena za kos / Cijena na komad 5,40 EUR)	3838987 572220	108,00
	KERIL - Specialno čistilo za KERROCK KERIL - Specialno sredstvo	krt = 12 x 0,5 l (Cena za kos / Cijena na komad 4,30 EUR)	3838987 747307	51,60

Masažni stebri Masažni stupovi		Program: kolpa·san®		
Model	Naziv in dimenzija izdelka Naziv i dimenzije produkta	Opis Opis	EAN koda EAN koda	Cena EUR Cijena EUR
Solano 1400 2f				
Kerrock barva / Boja				
	Solano 1400 2f - white 109	steber za tuš kabino, stenska izvedba, Kerrock stup za tuš kabinu, stijenska izvedba, Kerrock	3838987 564096	1.065,00
	Solano 1400 2f - andesite 9252		3838987 564072	1.065,00
Slim 1600 2f				
Kerrock barva / Boja				
	Slim 1600 2f - white 109	steber za tuš kabino, stenska izvedba, Kerrock stup za tuš kabinu, stijenska izvedba, Kerrock	3838987 564089	930,00
	Slim 1600 2f - andesite 9252		3838987 564065	930,00
Zonda FLAT 1600 3f				
Kerrock barva / Boja				
	Zonda FLAT 1600 3f - white 109	masažni steber za tuš kabino, stenska izvedba, Kerrock masažni stup za tuš kabinu, stijenska izvedba, Kerrock	3838987 572893	961,00
	Zonda FLAT 1600 3f - andesite 9252		3838987 927693	961,00
Zonda 1500 4f				
Kerrock barva / Boja				
	Zonda 1500 4f - white 109	masažni steber za tuš kabino, stenska izvedba, Kerrock masažni stup za tuš kabinu, stijenska izvedba, Kerrock	3838987 593607	1.161,00
	Zonda 1500 4f - andesite 9252		3838987 927679	1.161,00
Dodatki / Dodaci				
	Specialno čistilo KOLPA SAN Specialno sredstvo za čišćenje	krt = 20 x 0,5 l (Cena za kos / Cijena na komad 6,20 EUR)	3838987 747291	124,00
	Specialno čistilo ECO SAN Specialno sredstvo	krt = 20 x 0,5 l (Cena za kos / Cijena na komad 5,40 EUR)	3838987 572220	108,00
	KERIL - Specialno čistilo za KERROCK KERIL - Specialno sredstvo	krt = 12 x 0,5 l (Cena za kos / Cijena na komad 4,30 EUR)	3838987 747307	51,60
www.kolpasan.hr		www.kolpasan.si		121

Masažni stebri Masažni stupovi		Program: kolpa·san [®]		
Model	Naziv in dimenzija izdelka Naziv i dimenzije produkta	Opis Opis	EAN koda EAN koda	Cena EUR Cijena EUR
Zonda 1500 3f		Kerrock barva / Boja		
	Zonda 1500 3f - white 109	masažni steber za tuš kabino, stenska izvedba, Kerrock masažni stup za tuš kabinu, stijenska izvedba, Kerrock	3838987 570967	926,00
	Zonda 1500 3f - andesite 9252		3838987 927662	926,00
Zephyr 1680 3f		Kerrock barva / Boja		
	Zephyr 1680 3f - white 109	masažni steber za tuš kabino, stenska izvedba, Kerrock masažni stup za tuš kabinu, stijenska izvedba, Kerrock	3838987 962571	1.017,00
	Zephyr 1680 3f - andesite 9252		3838987 927709	1.017,00
Dodatki / Dodaci				
	Specialno čistilo KOLPA SAN Specialno sredstvo za čiščenje	krt = 20 x 0,5 l (Cena za kos / Cijena na komad 6,20 EUR)	3838987 747291	124,00
	Specialno čistilo ECO SAN Specijalno sredstvo	krt = 20 x 0,5 l (Cena za kos / Cijena na komad 5,40 EUR)	3838987 572220	108,00
	KERIL - Specialno čistilo za KERROCK KERIL - Specijalno sredstvo	krt = 12 x 0,5 l (Cena za kos / Cijena na komad 4,30 EUR)	3838987 747307	51,60



Tuš kadi Tuš kade

Acro 140, 120, 100	130	Limbo 140, 120	128
Ballo 200, 140	124	Limbo 140, 120 (3<)	129
Ballo 200, 140 (3<)	124	Macarena 100, 90	132
Canary 140, 120, 100, 90, 80	131	Malur 120, 100 -L	137
Capo 140, 120, 100, 90	130	Malur 120, 100 -D	137
Dixie 90	138	Moonwalk 140, 120, 100, 90	127
Drop 140, 120, 100, 90, 80	133	Moonwalk 140, 120, 100, 90 (3<)	128
Drop R 90, 80	137	Moonwalk R 100, 90	131
Evelin tray Q 120	136	Ontex 90, 80	139
Evelin tray Q 90, 80	136	Pandora tray 120, 100, 90	130
Evelin tray R 90, 80	139	Ramona tray 120	130
Flamenco 110, 100, 90, 80, 70	135	Re-Walk 180, 140	129
Flamenco 180, 170, 160, 140, 130, 120	134	Re-Walk 180, 140 (3<)	129
Funky 120, 100	135	Serra 140, 120, 90	132
Lavolta 160, 140, 120, 100, 90	125	Stiletto 130	129
Lavolta R 100, 90	126	Tello 160, 140, 120, 100, 90	124
Lerock ZERO 120, 100, 90	126	Tello 160, 140, 120, 100, 90 (3<)	124
		Trin 90, 80	136

7

let garancije
godina jamstva

Izdelki iz modificiranega akrila
Proizvod od modificiranog akrila

10

let garancije
godina jamstva

Izdelki iz Kerrocka, litega marmorja in litega sanitarnega akrila
Proizvod od Kerrocka, lijevanog mramora i od lijevanog sanitarnog akrila



Prizez tuš kadi po meri

Prilagođeno obrezivanje tuš kade











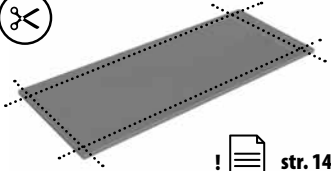

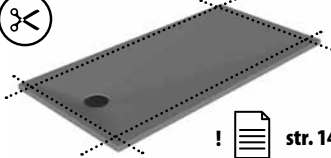

Tehnični listi prizezovanja; Ballo 140, Tello 141/142, Moonwalk 143, Limbo 144, Re-Walk 145

Tehnički list obrezivanja na strani; Ballo 140, Tello 141/142, Moonwalk 143, Limbo 144, Re-Walk 145

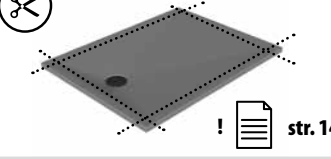

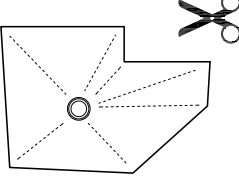

Slike so simbolične. Pravilna razporeditev elementov je v TEHNIČNEM KATALOGU na www.kolpasan.si

Slike su simbolične. Tačan raspored elemenata je u TEHNIČKOM KATALOGU na www.kolpasan.hr



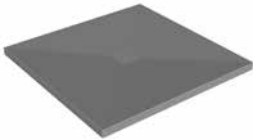
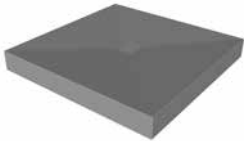

Tuš kadi Tuš kade		Program: Kerrock		kolpa·san [®]	
Model	Naziv in dimenzija izdelka Naziv i dimenzije produkta	Opis Opis	EAN koda EAN koda	Cena EUR Cijena EUR	
Ballo 200, 140					
		Barva / Boja			
	Ballo 200x90	- white 108	tuš kad za vgradnjo ali postavitve na tla iz Kerrocka	3838987 551119	954,00
	Ballo 200x80	- white 108	ugradbena kada za tuširanje ili instalacija na pod, od Kerrocka	3838987 551102	867,00
	Ballo 140x90	- white 108		3838987 551096	692,00
	Ballo 140x80	- white 108		3838987 551089	632,00
   str. 140	Ballo 200x90	- white 108	tuš kad za vgradnjo ali postavitve na tla iz Kerrocka	3838987 518228	1.098,00
	Ballo 200x80	- white 108	- prerez po meri	3838987 518211	997,00
	Ballo 140x90	- white 108	ugradbena kada za tuširanje ili instalacija na pod, od Kerrocka	3838987 518204	796,00
	Ballo 140x80	- white 108	- prilagođeno obrezivanje	3838987 518198	728,00
	Sifon Ø 90 brez pokrova H=65 mm		Sifon Ø 90 za tuš kadi, H=65 mm	3838987 563181	18,00
	Sifon Ø 90 brez pokrova H=84 mm		Sifon Ø 90 za tuš kade, H=65 mm		
			Sifon Ø 90 za tuš kadi, H=84 mm	3838987 927723	15,00
			Sifon Ø 90 za tuš kade, H=84 mm		
Tello 160, 140, 120, 100, 90					
	Tello 160x90	- white 108	tuš kad za vgradnjo ali postavitve na tla iz Kerrocka / ugradbena kada za tuširanje ili instalacija na pod, od Kerrocka	3838987 551072	774,00
	Tello 160x80	- white 108		3838987 551041	707,00
	Tello 140x90	- white 108	Priložen / priložen	3838987 551065	699,00
	Tello 140x80	- white 108	Sifon Ø 90 s kerrock pokrovom H=60 mm	3838987 551034	643,00
			Sifon Ø 90 s poklopcem od kerrocka H=60 mm		
	Tello 120x90	- white 108	tuš kad za vgradnjo ali postavitve na tla iz Kerrocka / ugradbena kada za tuširanje ili instalacija na pod, od Kerrocka	3838987 551058	627,00
	Tello 120x80	- white 108		3838987 551027	576,00
	Tello 100x80	- white 108	Priložen / priložen	3838987 551010	519,00
	Tello 90x90	- white 108	Sifon Ø 90 s kerrock pokrovom H=60 mm	3838987 551003	519,00
			Sifon Ø 90 s poklopcem od kerrocka H=60 mm		
   str. 141	Tello 160x90	- white 108	tuš kad za vgradnjo ali postavitve na tla iz Kerrocka / ugradbena kada za tuširanje ili instalacija na pod, od Kerrocka	3838987 518303	889,00
	Tello 160x80	- white 108		3838987 518273	813,00
	Tello 140x90	- white 108	- prerez po meri / - prilagođeno obrezivanje	3838987 518297	804,00
	Tello 140x80	- white 108		3838987 518266	739,00
   str. 141	Tello 120x90	- white 108	Priložen / priložen	3838987 518280	721,00
	Tello 120x80	- white 108	Sifon Ø 90 s kerrock pokrovom H=60 mm	3838987 518259	662,00
	Tello 100x80	- white 108	Sifon Ø 90 s poklopcem od kerrocka H=60 mm.	3838987 518242	597,00
	Tello 90x90	- white 108		3838987 518235	597,00
   str. 141	Tello - custom made		tuš kad za vgradnjo ali postavitve na tla iz Kerrocka / ugradbena kada za tuširanje ili instalacija na pod, od Kerrocka		po ponudbi po ponudi
			- dimenzija po meri - prilagođena dimenzija - položaj sifona po meri - prilagođeni položaj sifona - oblika po izmeri - oblik po mjeri Priložen / priložen Sifon Ø 90 s kerrock pokrovom H=60 mm. Sifon Ø 90 s poklopcem od kerrocka H=60 mm.		

Tuš kadi
 Tuš kade

Program: Kerrock
kolpa·san
BY KROKO

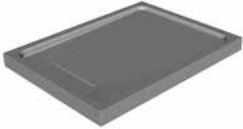

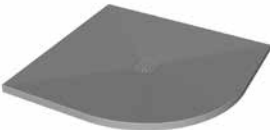
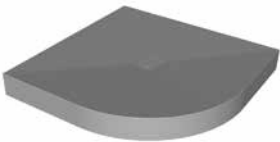



Model	Naziv in dimenzija izdelka Naziv i dimenzije produkta	Opis Opis	EAN koda EAN koda	Cena EUR Cijena EUR
				
				
				
				
	Sifon Ø 52 brez pokrova H=65 mm	Sifon Ø 52 za tuš kadi, H=65 mm Sifon Ø 52 za tuš kade, H=65 mm	3838987 563174	13,00

Tuš kadi
 Tuš kade









Tuš kadi Tuš kade		Program: Kerrock			kolpa·san®	
Model	Naziv in dimenzija izdelka Naziv i dimenzije produkta	Opis Opis	EAN koda EAN koda	Cena EUR Cijena EUR		
Lerock ZERO 120, 100, 90		Barva / Boja				
	Lerock ZERO 120x90 - white 109	tuš kad iz Kerrocka za vgradnjo z nivojem tal / ugradbena kada za tuširanje s razinom tla od Kerrocka priložen: /priložen: – visoko pretočni sifon Ø 52, visoko pretočni sifon Ø 52, – vodoodporna stop folija, vodoodporna stop folija, – stiropomi vložek. stiropor umetak.	3838987 570820	470,00		
	Lerock ZERO 120x80 - white 109		3838987 595991	435,00		
	Lerock ZERO 100x100 - white 109		3838987 570837	419,00		
	Lerock ZERO 90x90 - white 109		3838987 596011	372,00		
Ramona tray 120x90		Barva / Boja				
	Ramona tray 120x90 - white 108	tuš kad iz Kerrocka za postavev na tla kada od Kerrocka za tuširanje za instalaciju na pod	3838987 561118	721,00		
	 Sifon Ø 52 brez pokrova H=65 mm	Sifon Ø 52 za tuš kadi, H=65 mm Sifon Ø 52 za tuš kade, H=65 mm	3838987 563174	13,00		
Lavolta R 100, 90		Barva / Boja				
	Lavolta 100x100 - white 109	tuš kad za postavev na tla, polkrožna, iz Kerrocka kada za tuširanje za instalaciju na pod, polukružna, od Kerrocka	3838987 561330	457,00		
	Lavolta 90x90 - white 109		3838987 561323	373,00		
	Lavolta 90x90 - andesite 9252		3838987 518075	428,00		
	Lavolta 100x100/0 - white 109	tuš kad z oblogo iz Kerrocka kada za tuširanje s oblogom od Kerrocka	3838987 551263	652,00		
	Lavolta 90x90/0 - white 109		3838987 551249	522,00		
	Lavolta 90x90/0 - andesite 9252		3838987 551256	565,00		
 Sifon Ø 52 brez pokrova H=65 mm	Sifon Ø 52 za tuš kadi, H=65 mm Sifon Ø 52 za tuš kade, H=65 mm	3838987 563174	13,00			

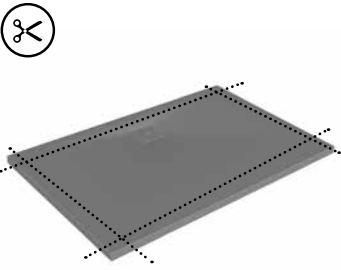





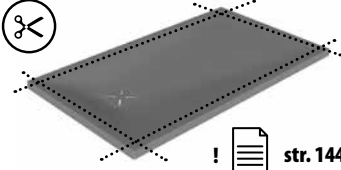

Tuš kadi
 Tuš kade

Program: Liti marmor
kolpa·san
BY ROOM





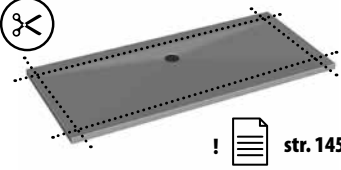



Model	Naziv in dimenzija izdelka Naziv i dimenzije produkta	Opis Opis	EAN koda EAN koda	Cena EUR Cijena EUR
Moonwalk 140, 120, 100, 90				
	Barva / Boja			
	Moonwalk 140x90 - white	tuš kad za vgradnjo, postavitve na tla ali v nivo tal iz LM, reliefna površina ugradbena kada za tuširanje, instalacijo na pod ili u nivo poda od LM, reliefnom površinom	3838987 596837	357,00
	Moonwalk 140x90 - antracit		3838987 596844	357,00
	Moonwalk 140x90 - manhattan		3838987 596868	357,00
	Moonwalk 140x80 - white		3838987 597070	334,00
	Moonwalk 140x80 - antracit		3838987 597087	334,00
	Moonwalk 140x80 - manhattan		3838987 597100	334,00
	Moonwalk 120x90 - white	tuš kad za vgradnjo, postavitve na tla ali v nivo tal iz LM, reliefna površina ugradbena kada za tuširanje, instalacijo na pod ili u nivo poda od LM, reliefnom površinom	3838987 596912	322,00
	Moonwalk 120x90 - antracit		3838987 596929	322,00
	Moonwalk 120x90 - manhattan		3838987 596943	322,00
	Moonwalk 120x80 - white		3838987 597032	312,00
	Moonwalk 120x80 - antracit		3838987 597049	312,00
	Moonwalk 120x80 - manhattan		3838987 597063	312,00
	Moonwalk 100x90 - white	tuš kad za vgradnjo, postavitve na tla ali v nivo tal iz LM, reliefna površina ugradbena kada za tuširanje, instalacijo na pod ili u nivo poda od LM, reliefnom površinom	3838987 597117	285,00
	Moonwalk 100x90 - antracit		3838987 597124	285,00
	Moonwalk 100x90 - manhattan		3838987 597148	285,00
	Moonwalk 100x80 - white		3838987 596998	274,00
	Moonwalk 100x80 - antracit		3838987 597001	274,00
	Moonwalk 100x80 - manhattan		3838987 597025	274,00
	Moonwalk 100x100 - white	tuš kad za vgradnjo, postavitve na tla ali v nivo tal iz LM, reliefna površina ugradbena kada za tuširanje, instalacijo na pod ili u nivo poda od LM, reliefnom površinom	3838987 596950	304,00
	Moonwalk 100x100 - antracit		3838987 596967	304,00
	Moonwalk 100x100 - manhattan		3838987 596981	304,00
	Moonwalk 90x90 - white		3838987 596875	274,00
	Moonwalk 90x90 - antracit		3838987 596882	274,00
	Moonwalk 90x90 - manhattan		3838987 596905	274,00
	Sifon Ø 90 brez pokrova H=65 mm	Sifon Ø 90 za tuš kadi, H=65 mm Sifon Ø 90 za tuš kade, H=65 mm	3838987 563181	18,00
	Sifon Ø 90 brez pokrova H=84 mm	Sifon Ø 90 za tuš kadi, H=84 mm Sifon Ø 90 za tuš kade, H=84 mm	3838987 927723	15,00
 9 x	Podnožje tuš kadi LM	Podnožje tuš kadi LM, (9 nogic) Podnožje za tuš kade LM, (9 nožica)	3838987 563150	35,00









Tuš kadi
 Tuš kade

Tuš kadi Tuš kade		Program: Liti marmor			kolpa·san®	
Model	Naziv in dimenzija izdelka Naziv i dimenzije produkta	Opis Opis	EAN koda EAN koda	Cena EUR Cijena EUR		
Moonwalk 140, 120, 100, 90						
  str. 143	Moonwalk 140x90	tuš kad za vgradnjo, postavitvev na tla ali v nivo tal iz LM, reliefna površina - prirez po meri ugradbena kada za tuširanje, instalacijo na pod ili u nivo poda od LM, reliefnom površinom - prilagođeno obrezivanje	3838987 932512	411,00		
	Moonwalk 140x80		3838987 932505	384,00		
	Moonwalk 120x90		3838987 932499	370,00		
	Moonwalk 120x80		3838987 932482	360,00		
	Moonwalk 100x100		3838987 932475	350,00		
	Moonwalk 100x90		3838987 932451	327,00		
	Moonwalk 100x80		3838987 932444	315,00		
Moonwalk 90x90	3838987 932437	315,00				
	Sifon Ø 90 brez pokrova H=65 mm	Sifon Ø 90 za tuš kadi, H=65 mm Sifon Ø 90 za tuš kade, H=65 mm	3838987 563181	18,00		
	Sifon Ø 90 brez pokrova H=84 mm	Sifon Ø 90 za tuš kadi, H=84 mm Sifon Ø 90 za tuš kade, H=84 mm	3838987 927723	15,00		
 9 x	Podnožje tuš kadi LM	Podnožje tuš kadi LM, (9 nogic) Podnožje za tuš kade LM, (9 nožica)	3838987 563150	35,00		
Limbo 140, 120						
		Barva / Boja				
	Limbo 140x90	- white	tuš kad za vgradnjo, postavitvev na tla ali v nivo tal iz LM, reliefna površina ugradbena kada za tuširanje, instalacijo na pod ili u nivo poda od LM, reliefnom površinom	3838987 551218	377,00	
	Limbo 140x90	- antracit		3838987 551232	377,00	
	Limbo 140x90	- manhattan		3838987 551225	377,00	
	Limbo 140x80	- white		3838987 551188	356,00	
	Limbo 140x80	- antracit		3838987 551201	356,00	
	Limbo 140x80	- manhattan		3838987 551195	356,00	
	Limbo 120x90	- white	tuš kad za vgradnjo, postavitvev na tla ali v nivo tal iz LM, reliefna površina ugradbena kada za tuširanje, instalacijo na pod ili u nivo poda od LM, reliefnom površinom	3838987 551157	340,00	
	Limbo 120x90	- antracit		3838987 551171	340,00	
	Limbo 120x90	- manhattan		3838987 551164	340,00	
	Limbo 120x80	- white		3838987 551126	327,00	
	Limbo 120x80	- antracit		3838987 551140	327,00	
	Limbo 120x80	- manhattan		3838987 551133	327,00	
	Sifon Ø 90 brez pokrova H=65 mm	Sifon Ø 90 za tuš kadi, H=65 mm Sifon Ø 90 za tuš kade, H=65 mm	3838987 563181	18,00		
	Sifon Ø 90 brez pokrova H=84 mm	Sifon Ø 90 za tuš kadi, H=84 mm Sifon Ø 90 za tuš kade, H=84 mm	3838987 927723	15,00		
 9 x	Podnožje tuš kadi LM	Podnožje tuš kadi LM, (9 nogic) Podnožje za tuš kade LM, (9 nožica)	3838987 563150	35,00		

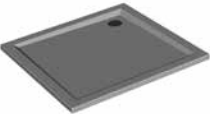
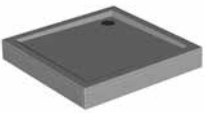
Tuš kadi Tuš kade		Program: Liti marmor		kolpa·san®	
Model	Naziv in dimenzija izdelka Naziv i dimenzije produkta	Opis Opis	EAN koda EAN koda	Cena EUR Cijena EUR	
Limbo 140, 120					
 ! str. 144	Limbo 140x90	tuš kad za vgradnjo, postavitve na tla ali v nivo tal iz LM, reliefna površina - prerez po meri ugradbena kada za tuširanje, instalacijo na pod ili u nivo poda od LM, reliefnom površinom - prilagođeno obrezivanje	3838987 518181	433,00	
	Limbo 140x80		3838987 518174	410,00	
	Limbo 120x90		3838987 518167	392,00	
	Limbo 120x80		3838987 518150	377,00	
	Sifon Ø 90 brez pokrova H=65 mm	Sifon Ø 90 za tuš kadi, H=65 mm Sifon Ø 90 za tuš kade, H=65 mm	3838987 563181	18,00	
	Sifon Ø 90 brez pokrova H=84 mm	Sifon Ø 90 za tuš kadi, H=84 mm Sifon Ø 90 za tuš kade, H=84 mm	3838987 927723	15,00	
 9 x	Podnožje tuš kadi LM	Podnožje tuš kadi LM, (9 nogic) Podnožje za tuš kade LM, (9 nožica)	3838987 563150	35,00	
Stiletto 130x90					
	Barva / Boja				
	Stiletto 130x90	- white	tuš kad za vgradnjo, postavitve na tla ali v nivo tal iz LM, reliefna površina ugradbena kada za tuširanje, instalacijo na pod ili u nivo poda od LM, reliefnom površinom	3838987 922797	369,00
	Stiletto 130x90	- antracit		3838987 927082	369,00
Stiletto 130x90	- manhattan	3838987 925132		369,00	
	Sifon Ø 52 brez pokrova H=65 mm	Sifon Ø 52 za tuš kadi, H=65 mm Sifon Ø 52 za tuš kade, H=65 mm	3838987 563174	13,00	
 9 x	Podnožje tuš kadi LM	Podnožje tuš kadi LM, (9 nogic) Podnožje za tuš kade LM, (9 nožica)	3838987 563150	35,00	
Re-Walk 180, 140					
	Re-Walk 180x80	tuš kad za vgradnjo, postavitve na tla ali v nivo tal iz LM ugradbena kada za tuširanje, instalacijo na pod ili u nivo poda od LM	3838987 597803	398,00	
	Re-Walk 140x90		3838987 563129	366,00	
	Re-Walk 140x80		3838987 597254	343,00	
 ! str. 145	Re-Walk 180x80	tuš kad za vgradnjo, postavitve na tla ali v nivo tal iz LM - prerez po meri ugradbena kada za tuširanje, instalacijo na pod ili u nivo poda od LM - prilagođeno obrezivanje	3838987 570806	458,00	
	Re-Walk 140x90		3838987 570691	421,00	
	Re-Walk 140x80		3838987 570813	395,00	
	Sifon Ø 90 s pokrovom H=65 mm	sifon Ø 90 za tuš kadi, H=65 mm sifon Ø 90 za tuš kade, H=65 mm	3838987 519904	25,00	
	Sifon Ø 90 s pokrovom H=84 mm	sifon Ø 90 za tuš kadi, H=84 mm sifon Ø 90 za tuš kade, H=84 mm	3838987 925873	16,00	
 12 x	Podnožje tuš kadi RE-WALK	Podnožje tuš kadi RE-WALK, (12 nogic) Podnožje za tuš kade RE-WALK, (12 nožica)	3838987 563167	45,00	





Tuš kadi Tuš kade		Program: Liti marmor		kolpa·san®	
Model	Naziv in dimenzija izdelka Naziv i dimenzije produkta	Opis Opis	EAN koda EAN koda	Cena EUR Cijena EUR	
Capo 140, 120, 100, 90					
	Capo 140x100	tuš kad za vgradnjo, postavitvev na tla ali v nivo tal iz LM ugradbena kada za tuširanje, instalacijo na pod ili u nivo poda od LM	3838987 565086	375,00	
	Capo 140x90		3838987 565079	355,00	
	Capo 120x90		3838987 565062	325,00	
	Capo 120x80		3838987 565048	308,00	
	Capo 100x80		3838987 565031	280,00	
	Capo 90x90		3838987 565055	280,00	
	Sifon Ø 90 brez pokrova H=65 mm	Sifon Ø 90 za tuš kadi, H=65 mm Sifon Ø 90 za tuš kade, H=65 mm	3838987 563181	18,00	
	Sifon Ø 90 brez pokrova H=84 mm	Sifon Ø 90 za tuš kadi, H=84 mm Sifon Ø 90 za tuš kade, H=84 mm	3838987 927723	15,00	
 9 x	Podnožje tuš kadi LM	Podnožje tuš kadi LM, (9 nogic) Podnožje za tuš kade LM, (9 nožica)	3838987 563150	35,00	
Acro 140, 120, 100					
	Acro 140x90	tuš kad za vgradnjo, postavitvev na tla ali v nivo tal iz LM ugradbena kada za tuširanje, instalacijo na pod ili u nivo poda od LM	3838987 560982	363,00	
	Acro 140x80		3838987 560975	346,00	
	Acro 120x90		3838987 560968	332,00	
	Acro 120x80		3838987 560951	315,00	
	Acro 100x90		3838987 560944	302,00	
	Acro 100x80		3838987 560937	280,00	
	Sifon Ø 90 brez pokrova H=65 mm	Sifon Ø 90 za tuš kadi, H=65 mm Sifon Ø 90 za tuš kade, H=65 mm	3838987 563181	18,00	
	Sifon Ø 90 brez pokrova H=84 mm	Sifon Ø 90 za tuš kadi, H=84 mm Sifon Ø 90 za tuš kade, H=84 mm	3838987 927723	15,00	
 9 x	Podnožje tuš kadi LM	Podnožje tuš kadi LM, (9 nogic) Podnožje za tuš kade LM, (9 nožica)	3838987 563150	35,00	
Pandora tray 120, 100, 90					
	Pandora tray 120x90	tuš kad za vgradnjo, postavitvev na tla ali v nivo tal iz LM ugradbena kada za tuširanje, instalacijo na pod ili u nivo poda od LM	3838987 560913	328,00	
	Pandora tray 120x80		3838987 560906	312,00	
	Pandora tray 100x90		3838987 560890	297,00	
	Pandora tray 100x80		3838987 560883	282,00	
	Pandora tray 90x90		3838987 560869	282,00	
	Sifon Ø 90 brez pokrova H=65 mm	Sifon Ø 90 za tuš kadi, H=65 mm Sifon Ø 90 za tuš kade, H=65 mm	3838987 563181	18,00	
	Sifon Ø 90 brez pokrova H=84 mm	Sifon Ø 90 za tuš kadi, H=84 mm Sifon Ø 90 za tuš kade, H=84 mm	3838987 927723	15,00	
 9 x	Podnožje tuš kadi LM	Podnožje tuš kadi LM, (9 nogic) Podnožje za tuš kade LM, (9 nožica)	3838987 563150	35,00	

Tuš kadi Tuš kade		Program: Liti marmor		kolpa·san®			
Model	Naziv in dimenzija izdelka Naziv i dimenzije produkta	Opis Opis	EAN koda EAN koda	Cena EUR Cijena EUR			
Canary 140, 120, 100, 90, 80							
	Canary 140x90	tuš kad za vgradnjo, postavitve na tla ali v nivo tal iz LM, ugradbena kada za tuširanje, instalacijo na pod ili u nivo poda od LM,	3838987 597247	294,00			
	Canary 120x90		3838987 597230	260,00			
	Canary 120x80		3838987 597209	246,00			
	Canary 100x80		3838987 597186	224,00			
	Canary 90x75		3838987 597162	197,00			
	Canary 140x90/0	tuš kad z oblogo iz LM kada za tuširanje s oblogom od LM	3838987 534570	474,00			
	Canary 120x90/0		3838987 534518	432,00			
	Canary 120x80/0		3838987 534549	415,00			
	Canary 100x80/0		3838987 534488	384,00			
	Canary 90x75/0		3838987 534457	343,00			
	Canary 100x100	tuš kad za vgradnjo, postavitve na tla ali v nivo tal iz LM ugradbena kada za tuširanje, instalacijo na pod ili u nivo poda od LM	3838987 597223	256,00			
	Canary 90x90		3838987 597193	224,00			
	Canary 80x80		3838987 922773	202,00			
	Canary 100x100/0	tuš kad z oblogo iz LM kada za tuširanje s oblogom od LM	3838987 534426	401,00			
	Canary 90x90/0		3838987 534396	381,00			
	Canary 80x80/0		3838987 923794	360,00			
	Sifon Ø 90 s pokrovom H=65 mm	sifon Ø 90 za tuš kadi, H=65 mm sifon Ø 90 za tuš kade, H=65 mm	3838987 519904	25,00			
	Sifon Ø 90 s pokrovom H=84 mm	sifon Ø 90 za tuš kadi, H=84 mm sifon Ø 90 za tuš kade, H=84 mm	3838987 925873	16,00			
 9 x	Podnožje tuš kadi LM	Podnožje tuš kadi LM, (9 nogic) Podnožje za tuš kade LM, (9 nožica)	3838987 563150	35,00			
Moonwalk R 100, 90							
	Barva / Boja		tuš kad za vgradnjo ali postavitve na tla iz LM, reliefna površina ugradbena kada za tuširanje ili instalacijo na pod od LM, reliefnom površinom	3838987 922766	301,00		
	Moonwalk 100x100	- white					
	Moonwalk 100x100	- antracit				3838987 922902	301,00
	Moonwalk 100x100	- manhattan				3838987 922896	301,00
	Moonwalk 90x90	- white				3838987 922780	271,00
	Moonwalk 90x90	- antracit				3838987 922889	271,00
	Sifon Ø 90 brez pokrova H=65 mm	Sifon Ø 90 za tuš kadi, H=65 mm Sifon Ø 90 za tuš kade, H=65 mm	3838987 563181	18,00			
	Sifon Ø 90 brez pokrova H=84 mm	Sifon Ø 90 za tuš kadi, H=84 mm Sifon Ø 90 za tuš kade, H=84 mm	3838987 927723	15,00			
	 9 x	Podnožje tuš kadi LM	Podnožje tuš kadi LM, (9 nogic) Podnožje za tuš kade LM, (9 nožica)	3838987 563150	35,00		



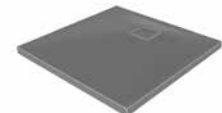



Tuš kadi Tuš kade		Program: Liti marmor		kolpa·san®	
Model	Naziv in dimenzija izdelka Naziv i dimenzije produkta	Opis Opis	EAN koda EAN koda	Cena EUR Cijena EUR	
Macarena 100, 90					
	Macarena 100x100	tuš kad za vgradnjo ali postavitev na tla, polkrožna iz LM ugradbena kade za tuširanje ili instalaciju na pod, polukružna od LM	3838987 597216	254,00	
	Macarena 90x90		3838987 597179	220,00	
	Macarena 100x100/0	tuš kad z oblogo, polkrožna iz LM kade za tuširanje s oblogom, polukružna od LM	3838987 534631	391,00	
	Macarena 90x90/0		3838987 534600	365,00	
	Sifon Ø 90 s pokrovom H=65 mm	sifon Ø 90 za tuš kadi, H=65 mm sifon Ø 90 za tuš kade, H=65 mm	3838987 519904	25,00	
	Sifon Ø 90 s pokrovom H=84 mm	sifon Ø 90 za tuš kadi, H=84 mm sifon Ø 90 za tuš kade, H=84 mm	3838987 925873	16,00	
 9 x	Podnožje tuš kadi LM	Podnožje tuš kadi LM, (9 nogic) Podnožje za tuš kade LM, (9 nožica)	3838987 563150	35,00	



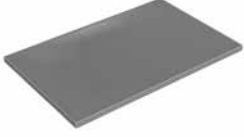

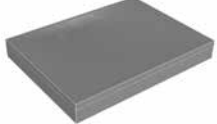

Program: Modificiran akril		kolpa·san®									
Serra 140, 120, 90											
	Barva / Boja		tuš kad za vgradnjo ali postavitev na tla, reliefna površina ugradbena kade za tuširanje ili instalaciju na pod, reljefnom površinom	3838987 576297	259,00						
	Serra 140x90	- white				3838987 576273	259,00				
	Serra 140x90	- graphite						3838987 576389	236,00		
	Serra 140x80	- white								3838987 576365	236,00
	Serra 140x80	- graphite									
	Serra 120x90	- white								3838987 576303	228,00
	Serra 120x90	- graphite						3838987 576419	204,00		
	Serra 120x80	- white								3838987 576396	204,00
	Serra 120x80	- graphite						3838987 576440	174,00		
		Serra 90x90								- white	3838987 576426
		Serra 90x90						- graphite			
		Sifon Ø 90 brez pokrova H=65 mm						Sifon Ø 90 za tuš kadi, H=65 mm Sifon Ø 90 za tuš kade, H=65 mm	3838987 563181	18,00	
Sifon Ø 90 brez pokrova H=84 mm		Sifon Ø 90 za tuš kadi, H=84 mm Sifon Ø 90 za tuš kade, H=84 mm	3838987 927723	15,00							
132	www.kolpasan.si	www.kolpasan.hr									



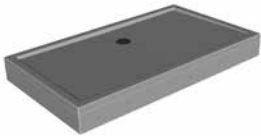

Tuš kadi
 Tuš kade

Program: Liti sanitarni akril
kolpa·san
by KOLPA



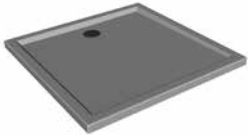
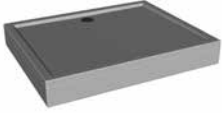







Model	Naziv in dimenzija izdelka Naziv i dimenzije produkta	Opis Opis	EAN koda EAN koda	Cena EUR Cijena EUR
Drop 140, 120, 100, 90, 80				
	Drop 140x90	tuš kad za vgradnjo ali postavitev na tla ugradbena kada za tuširanje ili instalaciju na pod	3838987 565666	254,00
	Drop 140x80		3838987 565659	249,00
	Drop 120x90		3838987 565673	244,00
	Drop 120x80		3838987 565642	231,00
	Drop 140x90/0	tuš kad z oblogo kada za tuširanje s oblogom	3838987 566038	349,00
	Drop 140x80/0		3838987 566021	342,00
	Drop 120x90/0		3838987 566014	336,00
	Drop 120x80/0		3838987 566007	322,00
	Drop 100x90	tuš kad za vgradnjo ali postavitev na tla ugradbena kada za tuširanje ili instalaciju na pod	3838987 565949	225,00
	Drop 100x80		3838987 565635	207,00
	Drop 90x90		3838987 565611	204,00
	Drop 80x80		3838987 565604	181,00
	Drop 100x90/0	tuš kad z oblogo kada za tuširanje s oblogom	3838987 565994	319,00
	Drop 100x80/0		3838987 565987	297,00
	Drop 90x90/0		3838987 565970	295,00
	Drop 80x80/0		3838987 565932	274,00
	Sifon Ø 52 brez pokrova H=65 mm	Sifon Ø 52 za tuš kadi, H=65 mm Sifon Ø 52 za tuš kade, H=65 mm	3838987 563174	13,00

Tuš kadi
 Tuš kade

Tuš kadi Tuš kade	Program: Liti sanitarni akril			
Model	Naziv in dimenzija izdelka Naziv i dimenzije produkta	Opis Opis	EAN koda EAN koda	Cena EUR Cijena EUR
Flamenco 180, 170, 160, 140, 130, 120				
	Flamenco 180x80 Flamenco 170x80 Flamenco 170x75 Flamenco 160x90 Flamenco 160x80 Flamenco 160x70	tuš kad za vgradnjo ugradbena kada za tuširanje	3838987 782186 3838987 782193 3838987 999720 3838987 785668 3838987 572787 3838987 999713	318,00 285,00 282,00 262,00 260,00 258,00
	Flamenco 180x80/0 Flamenco 170x80/0 Flamenco 170x75/0 Flamenco 160x90/0 Flamenco 160x80/0 Flamenco 160x70/0	tuš kad z oblogo kada za tuširanje s oblogom	3838987 534754 3838987 994923 3838987 534648 3838987 534617 3838987 572800 3838987 534587	471,00 439,00 437,00 415,00 413,00 411,00
	Flamenco 140x90 Flamenco 140x80 Flamenco 140x70 Flamenco 130x90 Flamenco 130x80 Flamenco 120x100 Flamenco 120x90 Flamenco 120x80 Flamenco 120x70	tuš kad za vgradnjo ugradbena kada za tuširanje	3838987 533863 3838987 572206 3838987 572770 3838987 533849 3838987 945871 3838987 576167 3838987 766148 3838987 785941 3838987 571094	248,00 245,00 242,00 245,00 242,00 247,00 239,00 226,00 224,00
	Flamenco 140x90/0 Flamenco 140x80/0 Flamenco 140x70/0 Flamenco 130x90/0 Flamenco 130x80/0 Flamenco 120x100/0 Flamenco 120x90/0 Flamenco 120x80/0 Flamenco 120x70/0	tuš kad z oblogo kada za tuširanje s oblogom	3838987 533870 3838987 572213 3838987 572794 3838987 533856 3838987 945888 3838987 576174 3838987 755548 3838987 919728 3838987 571100	343,00 338,00 333,00 338,00 333,00 342,00 331,00 318,00 316,00
	Sifon Ø 90 s pokrovom H=65 mm Sifon Ø 90 s pokrovom H=84 mm	sifon Ø 90 za tuš kadi, H=65 mm sifon Ø 90 za tuš kade, H=65 mm sifon Ø 90 za tuš kadi, H=84 mm sifon Ø 90 za tuš kade, H=84 mm	3838987 519904 3838987 925873	25,00 16,00



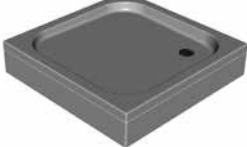

Tuš kadi Tuš kade		Program: Liti sanitarni akril			kolpa·san [®]	
Model	Naziv in dimenzija izdelka Naziv i dimenzije produkta	Opis Opis	EAN koda EAN koda	Cena EUR Cijena EUR		
Flamenco 110, 100, 90, 80, 70						
	Flamenco 110x90	tuš kad za vgradnjo ugradbena kada za tuširanje	3838987 533825	227,00		
	Flamenco 110x80		3838987 533801	215,00		
	Flamenco 100x100		3838987 961420	227,00		
	Flamenco 100x90		3838987 785620	220,00		
	Flamenco 100x80		3838987 571070	207,00		
	Flamenco 90x90		3838987 782636	200,00		
	Flamenco 90x80		3838987 596134	186,00		
	Flamenco 90x70		3838987 571131	177,00		
	Flamenco 80x80		3838987 518365	177,00		
	Flamenco 70x70		3838987 571117	171,00		
	Flamenco 110x90/0	tuš kad z oblogo kada za tuširanje s oblogom	3838987 533832	319,00		
	Flamenco 110x80/0		3838987 533818	308,00		
	Flamenco 100x100/0		3838987 961437	319,00		
	Flamenco 100x90/0		3838987 994800	315,00		
	Flamenco 100x80/0		3838987 571087	297,00		
	Flamenco 90x90/0		3838987 534761	291,00		
	Flamenco 90x80/0		3838987 596141	279,00		
	Flamenco 90x70/0		3838987 571148	270,00		
	Flamenco 80x80/0		3838987 518358	270,00		
	Flamenco 70x70/0		3838987 571124	261,00		
	Sifon Ø 90 s pokrovom H=65 mm	sifon Ø 90 za tuš kadi, H=65 mm sifon Ø 90 za tuš kade, H=65 mm	3838987 519904	25,00		
	Sifon Ø 90 s pokrovom H=84 mm		sifon Ø 90 za tuš kadi, H=84 mm sifon Ø 90 za tuš kade, H=84 mm	3838987 925873	16,00	
Funky 120, 100						
	Funky 120x90	tuš kad s sedežem za vgradnjo tuš kada sa sjedalom za ugradnju	3838987 592969	291,00		
	Funky 100x80		3838987 592945	254,00		
priložena: /priložen: – odlivno/prelivna garnitura s sifonom UP&DOWN Ø 52, odlivno/prelivna garnitura sa sifonom UP&DOWN Ø 52						
	Funky 120x90/0	tuš kad s sedežem z oblogo tuš kada sa sjedalom sa oblogom	3838987 592952	501,00		
	Funky 100x80/0		3838987 592938	452,00		
montirana: /namještena: – odlivno/prelivna garnitura s sifonom UP&DOWN Ø 52, odlivno/prelivna garnitura sa sifonom UP&DOWN Ø 52						









Tuš kadi Tuš kade	Program: Liti sanitarni akril			
Model	Naziv in dimenzija izdelka Naziv i dimenzije produkta	Opis Opis	EAN koda EAN koda	Cena EUR Cijena EUR
Evelin tray Q 120				
	Evelin tray Q 120x90 Evelin tray Q 120x80	tuš kad za vgradnjo ali postavitev na tla ugradbena kada za tuširanje ili instalaciju na pod	3838987 593164 3838987 593324	193,00 180,00
	Evelin tray Q 120x90/0 Evelin tray Q 120x80/0	tuš kad z oblogo kada za tuširanje s oblogom	3838987 593171 3838987 593331	281,00 269,00
	Sifon Ø 90 s pokrovom H=65 mm	sifon Ø 90 za tuš kadi, H=65 mm sifon Ø 90 za tuš kade, H=65 mm	3838987 519904	25,00
	Sifon Ø 90 s pokrovom H=84 mm	sifon Ø 90 za tuš kadi, H=84 mm sifon Ø 90 za tuš kade, H=84 mm	3838987 925873	16,00
Evelin tray Q 90, 80				
	Evelin tray Q 90x90 Evelin tray Q 80x80	tuš kad za vgradnjo ugradbena kada za tuširanje	3838987 593034 3838987 593287	106,00 98,00
	Evelin tray Q 90x90/0 Evelin tray Q 80x80/0	tuš kad z oblogo kada za tuširanje s oblogom	3838987 593041 3838987 593294	185,00 179,00
	Sifon Ø 90 s pokrovom H=65 mm	sifon Ø 90 za tuš kadi, H=65 mm sifon Ø 90 za tuš kade, H=65 mm	3838987 519904	25,00
	Sifon Ø 90 s pokrovom H=84 mm	sifon Ø 90 za tuš kadi, H=84 mm sifon Ø 90 za tuš kade, H=84 mm	3838987 925873	16,00
Trin 90, 80				
	Trin 90x90 Trin 80x80	tuš kad za vgradnjo ugradbena kada za tuširanje	3838987 754817 3838987 754800	108,00 101,00
	Trin 90x90/0 Trin 80x80/0	tuš kad z oblogo kada za tuširanje s oblogom	3838987 755135 3838987 754893	187,00 181,00
	Sifon Ø 52 s pokrovom H=65 mm	Sifon Ø 52 za tuš kadi, H=65 mm Sifon Ø 52 za tuš kade, H=65 mm	3838987 512981	15,00

Tuš kadi Tuš kade		Program: Liti sanitarni akril			kolpa·san <small>by KOLPA</small>	
Model	Naziv in dimenzija izdelka Naziv i dimenzije produkta	Opis Opis	EAN koda EAN koda	Cena EUR Cijena EUR		
Malur 120, 100, -L						
	Malur 120x90 -L	tuš kad za vgradnjo, polkrožna, asimetrična ugradbena kada za tuširanje, polukružna, asimetrična	3838987 792826	226,00		
	Malur 100x80 -L		3838987 793168	210,00		
	Malur 120x90/0 -L	tuš kad z oblogo, polkrožna, asimetrična kada za tuširanje s oblogom, polukružna, asimetrična	3838987 537076	318,00		
	Malur 100x80/0 -L		3838987 755555	301,00		
	Sifon Ø 90 s pokrovom H=65 mm	sifon Ø 90 za tuš kadi, H=65 mm sifon Ø 90 za tuš kade, H=65 mm	3838987 519904	25,00		
	Sifon Ø 90 s pokrovom H=84 mm		sifon Ø 90 za tuš kadi, H=84 mm sifon Ø 90 za tuš kade, H=84 mm	3838987 925873	16,00	
Malur 120, 100, -D						
	Malur 120x90 -D	tuš kad za vgradnjo, polkrožna, asimetrična ugradbena kada za tuširanje, polukružna, asimetrična	3838987 766254	226,00		
	Malur 100x80 -D		3838987 793601	210,00		
	Malur 120x90/0 -D	tuš kad z oblogo, polkrožna, asimetrična kada za tuširanje s oblogom, polukružna, asimetrična	3838987 537083	318,00		
	Malur 100x80/0 -D		3838987 537069	301,00		
	Sifon Ø 90 s pokrovom H=65 mm	sifon Ø 90 za tuš kadi, H=65 mm sifon Ø 90 za tuš kade, H=65 mm	3838987 519904	25,00		
	Sifon Ø 90 s pokrovom H=84 mm		sifon Ø 90 za tuš kadi, H=84 mm sifon Ø 90 za tuš kade, H=84 mm	3838987 925873	16,00	
Drop R 90, 80						
	Drop R 90x90	tuš kad za vgradnjo ali postavev na tla, polkrožna ugradbena kada za tuširanje ili instalacijo na pod, polukružna	3838987 565697	199,00		
	Drop R 80x80		3838987 565680	175,00		
	Drop R 90x90/0	tuš kad z oblogo, polkrožna kada za tuširanje s oblogom, polukružna	3838987 566052	290,00		
	Drop R 80x80/0		3838987 566045	269,00		
	Sifon Ø 52 brez pokrova H=65 mm	Sifon Ø 52 za tuš kadi, H=65 mm Sifon Ø 52 za tuš kade, H=65 mm	3838987 563174	13,00		



Tuš kadi Tuš kade		Program: Liti sanitarni akril			kolpa·san <small>BY KOLPA</small>	
Model	Naziv in dimenzija izdelka Naziv i dimenzije produkta	Opis Opis	EAN koda EAN koda	Cena EUR Cijena EUR		
Dixie 90						
	Dixie 90x90	tuš kad za vgradnjo, polkrožna, globina 30 cm ugradbena kada za tuširanje, polukružna, globina 30 cm	3838987 790075	204,00		
	Dixie 90x90/0	tuš kad z oblogo, polkrožna kada za tuširanje s oblogom, polukružna	3838987 788737	372,00		
	Sifon Ø 52 s pokrovom H=65 mm	Sifon Ø 52 za tuš kadi, H=65 mm Sifon Ø 52 za tuš kade, H=65 mm	3838987 512981	15,00		
SQ line TKP 90 /CH DIXIE						
	TKP 90 /CH DIXIE Silver SQ line	tuš kabina - polkrožna, za tuš kad Dixie, h=160, silver profili tuš kabina - polukružna, za tuš kadu Dixie, h=160, silver profili	3838987 511502	394,00		
	TKP 90 /CH DIXIE Bela SQ line	tuš kabina - polkrožna, za tuš kad Dixie, h=160, beli profili tuš kabina - polukružna, za tuš kadu Dixie, h=160, beli profili	3838987 511496	330,00		

Tuš kadi Tuš kade	Program: Liti sanitarni akril			
Model	Naziv in dimenzija izdelka Naziv i dimenzije produkta	Opis Opis	EAN koda EAN koda	Cena EUR Cijena EUR
Evelin tray R 90, 80				
	Evelin tray R 90x90 Evelin tray R 80x80	tuš kad za vgradnjo, polkrožna ugradbena kada za tuširanje, polukružna	3838987 593058 3838987 593300	106,00 98,00
	Evelin tray R 90x90/0 Evelin tray R 80x80/0	tuš kad z oblogo kada za tuširanje s oblogom	3838987 593065 3838987 593317	185,00 179,00
	Sifon Ø 90 s pokrovom H=65 mm	sifon Ø 90 za tuš kadi, H=65 mm sifon Ø 90 za tuš kade, H=65 mm	3838987 519904	25,00
	Sifon Ø 90 s pokrovom H=84 mm	sifon Ø 90 za tuš kadi, H=84 mm sifon Ø 90 za tuš kade, H=84 mm	3838987 925873	16,00
Ontex 90, 80				
	Ontex 90x90 Ontex 80x80	tuš kad za vgradnjo, polkrožna ugradbena kada za tuširanje, polukružna	3838987 754886 3838987 754879	108,00 101,00
	Ontex 90x90/0 Ontex 80x80/0	tuš kad z oblogo, polkrožna kada za tuširanje s oblogom, polukružna	3838987 755159 3838987 755142	187,00 181,00
	Sifon Ø 52 s pokrovom H=65 mm	Sifon Ø 52 za tuš kadi, H=65 mm Sifon Ø 52 za tuš kade, H=65 mm	3838987 512981	15,00



Customer:

Name and Surname	
Address	
E-mail	
Phone number	



Properties:

Model	BALLO		
Dimensions (AxB)	2000 x _____ mm		
Color	White		
Cutting option			

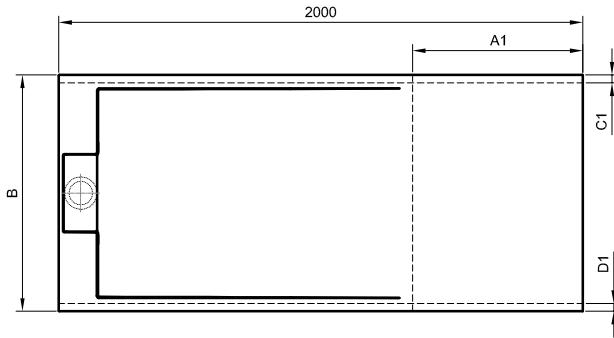

Option 1

A1 [mm]	max. 650mm	C1 [mm]	max. 30mm	D1 [mm]	max. 30mm
---------	------------	---------	-----------	---------	-----------

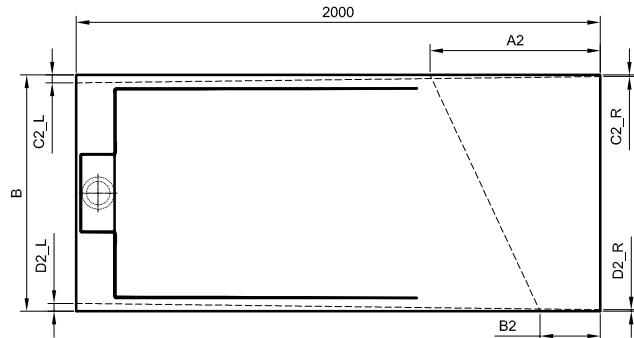

Option 2

A2 [mm]	max. 650mm	C2_L [mm]	max. 30mm	D2_L [mm]	max. 30mm
B2 [mm]		C2_R [mm]		D2_R [mm]	

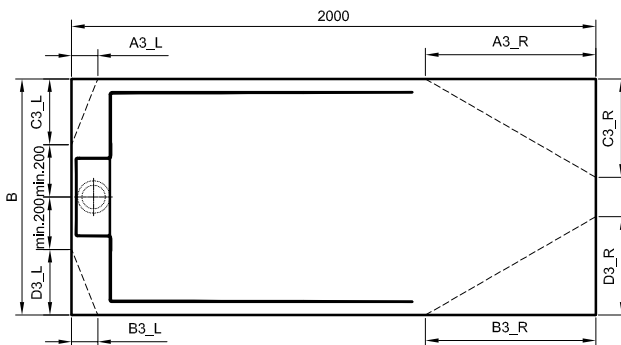

Option 3

A3_L [mm]	max. 100mm	A3_R [mm]	max. 650mm	C3_L [mm]	max. (B/2)-200mm
B3_L [mm]		B3_R [mm]		D3_L [mm]	
				C3_R [mm]	
				D3_R [mm]	

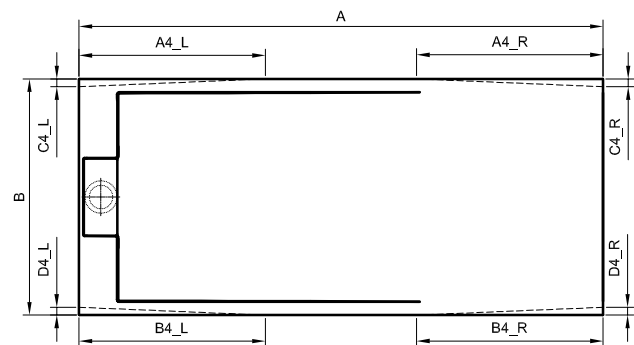

Option 4

A4_L [mm]		A4_R [mm]		C4_L [mm]	max. 30mm
B4_L [mm]		B4_R [mm]		D4_L [mm]	
				C4_R [mm]	max. 30mm
				D4_R [mm]	

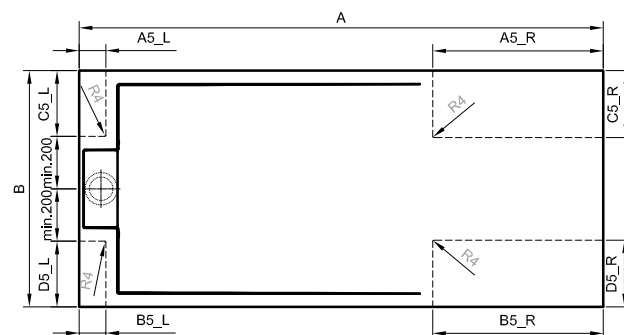

Option 5

A5_L [mm]	max. 120mm	A5_R [mm]	max. 650mm	C5_L [mm]	max. (B/2)-200mm
B5_L [mm]		B5_R [mm]		D5_L [mm]	
				C5_R [mm]	max. B/3
				D5_R [mm]	

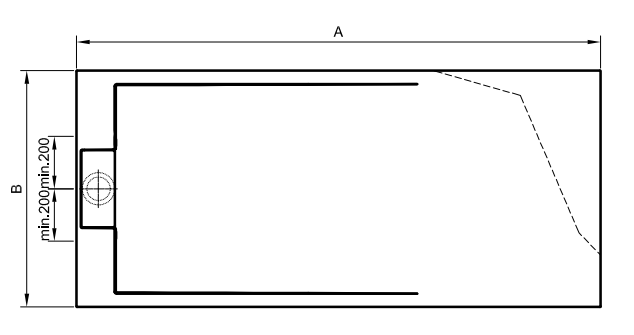

Option 6

Special requirements

- mark and quote the cuts in the image

Customer:

Name and Surname	
Address	
E-mail	
Phone number	

Properties:

Model	TELLO		
Dimensions (AxB)	_____ x _____ mm		
Color	White		
Cutting option			

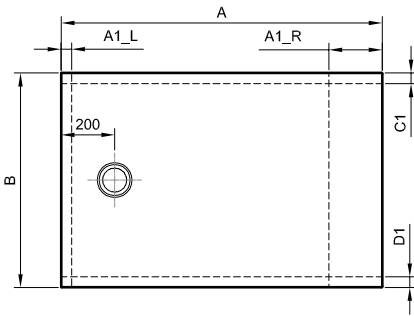

Option 1

	max. 40mm
A1_L [mm]	
	max. 200mm
A1_R [mm]	
	max. 40mm
C1 [mm]	
	max. 40mm
D1 [mm]	

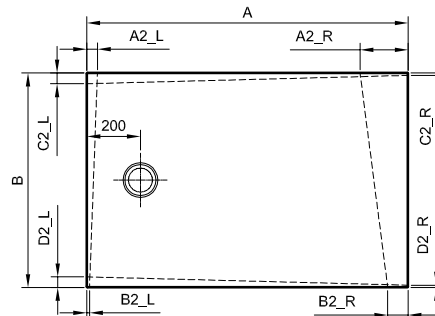

Option 2

	max. 40mm
A2_L [mm]	
	max. 200mm
B2_L [mm]	
	max. 40mm
C2_L [mm]	
	max. 40mm
C2_R [mm]	
	max. 40mm
D2_L [mm]	
	max. 40mm
D2_R [mm]	

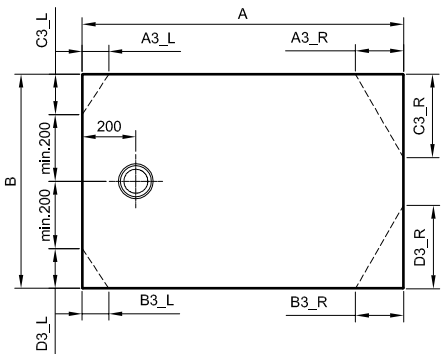

Option 3

	max. 100mm
A3_L [mm]	
	max. 180mm
B3_L [mm]	
	max. (A/2)-200mm
C3_L [mm]	
C3_R [mm]	
D3_L [mm]	
D3_R [mm]	

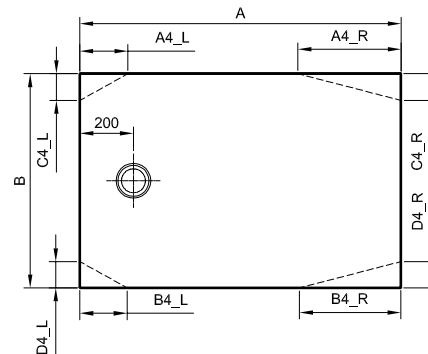

Option 4

	max. A/3
A4_L [mm]	
	max. A/3
B4_L [mm]	
	max. 100mm
C4_L [mm]	
	max. 100mm
C4_R [mm]	
	max. 100mm
D4_L [mm]	
	max. 100mm
D4_R [mm]	

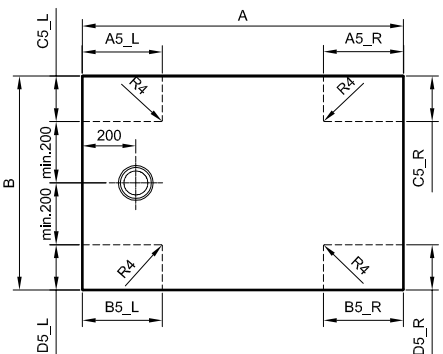

Option 5

	max. A/3
A5_L [mm]	
	max. A/3
B5_L [mm]	
	max. (B/2)-200mm
C5_L [mm]	
	max. B/3
C5_R [mm]	
	max. B/3
D5_L [mm]	
	max. B/3
D5_R [mm]	

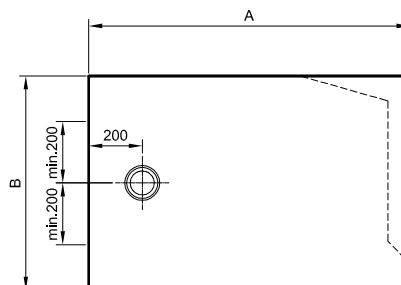

Option 6

Special requirements

<- mark and quote the cuts in the image



SHOWER TUB - CUSTOM MADE

Model	TELLO
	Custom made
Dimension (A x B)	
Color	



CUSTOMER	
Name and Surname	
Address	
E-mail	
Phone number	

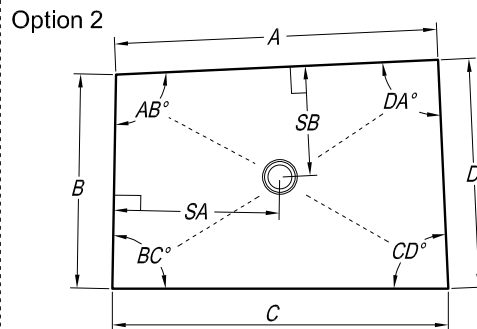
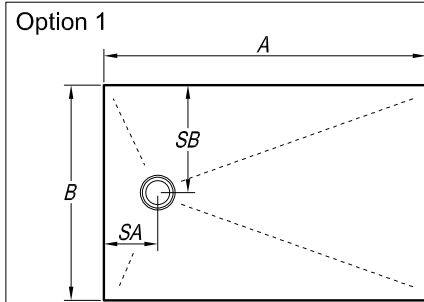

DIMENSIONS	
Option	
A	
B	
C	
D	
E	
R 550	

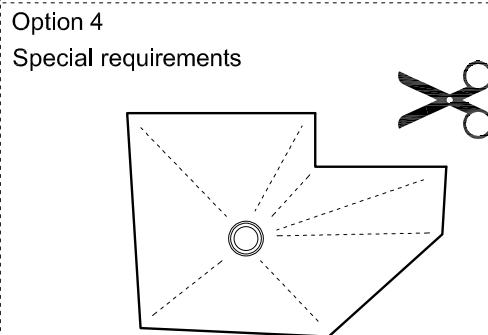
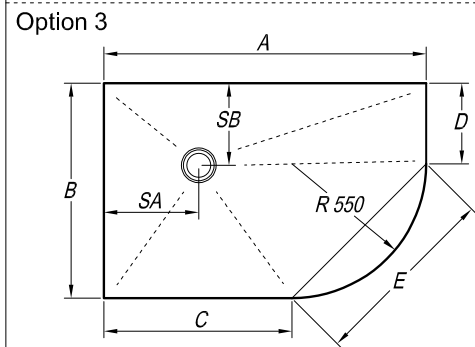

ANGLE (00,0°)	
AB°	
BC°	
CD°	
DA°	

MIDDLE OF OUTFLOW	
SA (min. 200)	
SB (min. 200)	

Special requirements

Sketch with dimensions

Customer:

Name and Surname	
Address	
E-mail	
Phone number	

Properties:

Model	MOONWALK		
Dimensions (AxB)	_____ x _____ mm		
Color	White	Antracit	Manhattan
Cutting option			

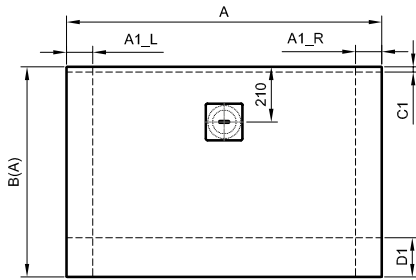

Option 1

	max. 100mm
A1_L [mm]	
A1_R [mm]	
	max. 20mm
C1 [mm]	
	max. 150mm
D1 [mm]	

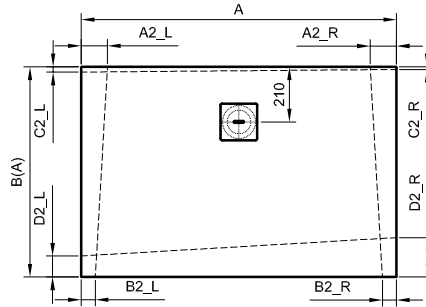

Option 2

	max. 100mm
A2_L [mm]	
A2_R [mm]	
	max. 100mm
B2_L [mm]	
B2_R [mm]	
	max. 20mm
C2_L [mm]	
C2_R [mm]	
	max. 150mm
D2_L [mm]	
D2_R [mm]	

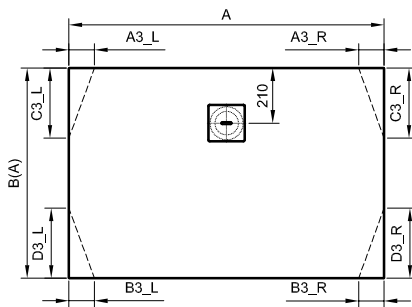

Option 3

	max. 100mm
A3_L [mm]	
A3_R [mm]	
	max. 100mm
B3_L [mm]	
B3_R [mm]	
C3_L [mm]	
C3_R [mm]	
D3_L [mm]	
D3_R [mm]	

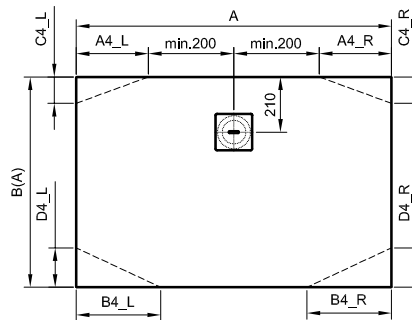

Option 4

	max. (A/2)-200mm
A4_L [mm]	
A4_R [mm]	
B4_L [mm]	
B4_R [mm]	
	max. 100mm
C4_L [mm]	
C4_R [mm]	
	max. 150mm
D4_L [mm]	
D4_R [mm]	

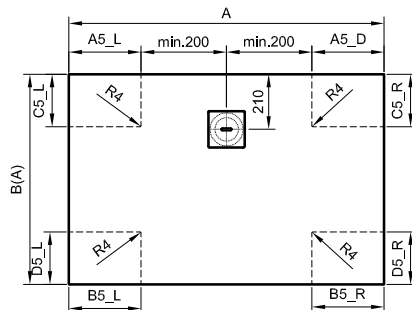

Option 5

	max. (A/2)-200mm
A5_L [mm]	
A5_R [mm]	
	max. A/3
B5_L [mm]	
B5_R [mm]	
	max. B(A)/3
C5_L [mm]	
C5_R [mm]	
	max. B(A)/3
D5_L [mm]	
D5_R [mm]	

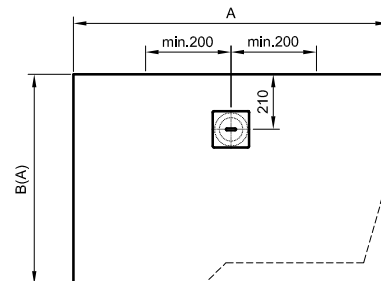

Option 6

Special requirements
<- mark and quote the cuts in the image



Customer:

Name and Surname	
Address	
E-mail	
Phone number	

Properties:

Model	LIMBO		
Dimensions (AxB)	_____ x _____ mm		
Color	White	Antracit	Manhattan
Cutting option			

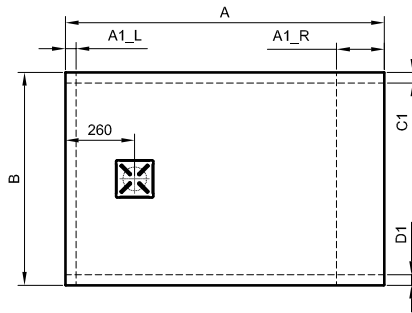

Option 1

	max. 40mm
A1_L [mm]	
	max. 180mm
A1_R [mm]	
	max. 40mm
C1 [mm]	
	max. 40mm
D1 [mm]	

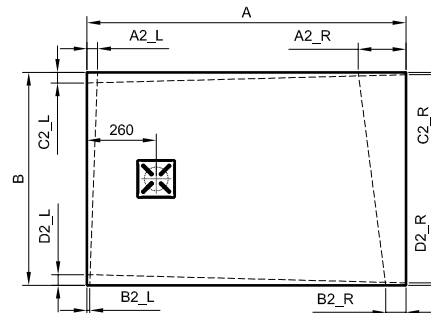

Option 2

	max. 40mm
A2_L [mm]	
B2_L [mm]	
	max. 180mm
A2_R [mm]	
B2_R [mm]	
	max. 40mm
C2_L [mm]	
C2_R [mm]	
	max. 40mm
D2_L [mm]	
D2_R [mm]	

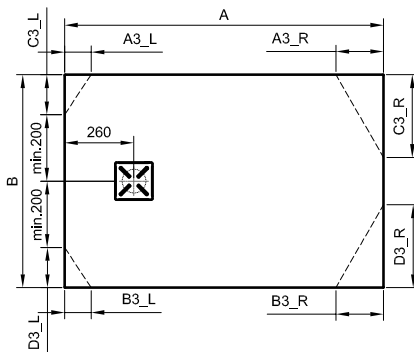

Option 3

	max. 100mm
A3_L [mm]	
B3_L [mm]	
	max. 180mm
A3_R [mm]	
B3_R [mm]	
	max. (B/2)-200mm
C3_L [mm]	
D3_L [mm]	
C3_R [mm]	
D3_R [mm]	

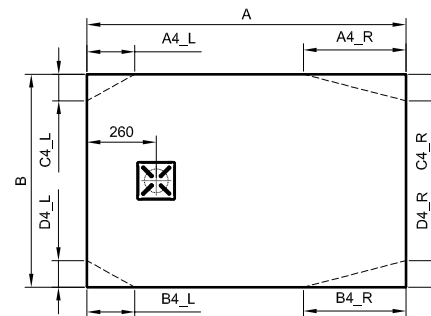

Option 4

	max. A/3
A4_L [mm]	
B4_L [mm]	
	max. A/3
A4_R [mm]	
B4_R [mm]	
	max. 100mm
C4_L [mm]	
D4_L [mm]	
	max. 100mm
C4_R [mm]	
D4_R [mm]	

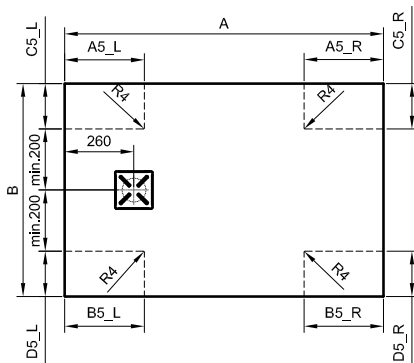

Option 5

	max. A/3
A5_L [mm]	
B5_L [mm]	
	max. A/3
A5_R [mm]	
B5_R [mm]	
	max. (B/2)-200mm
C5_L [mm]	
D5_L [mm]	
	max. B/3
C5_R [mm]	
D5_R [mm]	

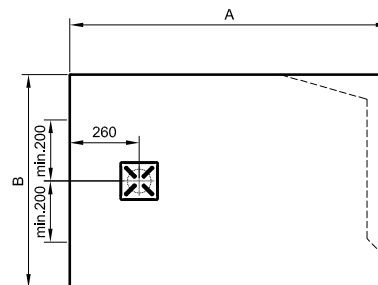

Option 6

Special requirements
<- mark and quote the cuts in the image

Customer:

Name and Surname	
Address	
E-mail	
Phone number	

Properties:

Model	RE-WALK		
Dimensions (AxB)	_____ x _____ mm		
Color	White		
Cutting option			

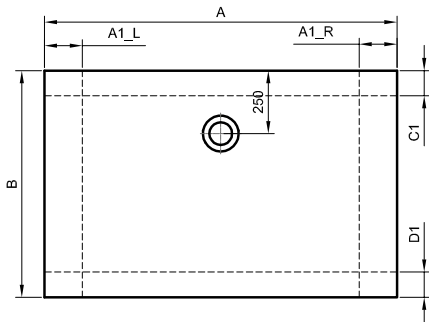

Option 1

	max. 150mm
A1_L [mm]	
A1_R [mm]	
	max. 100mm
C1 [mm]	
	max. 150mm
D1 [mm]	

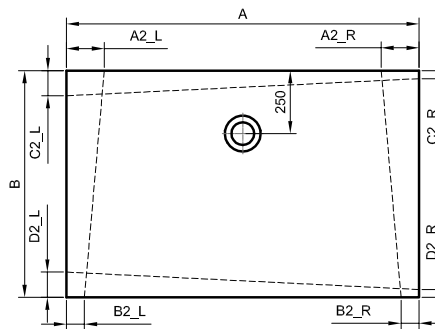

Option 2

	max. 150mm
A2_L [mm]	
A2_R [mm]	
	max. 150mm
B2_L [mm]	
B2_R [mm]	
	max. 100mm
C2_L [mm]	
C2_R [mm]	
	max. 150mm
D2_L [mm]	
D2_R [mm]	

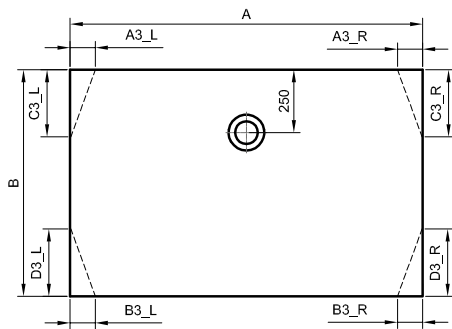

Option 3

	max. 150mm
A3_L [mm]	
A3_R [mm]	
	max. 150mm
B3_L [mm]	
B3_R [mm]	
C3_L [mm]	
C3_R [mm]	
D3_L [mm]	
D3_R [mm]	

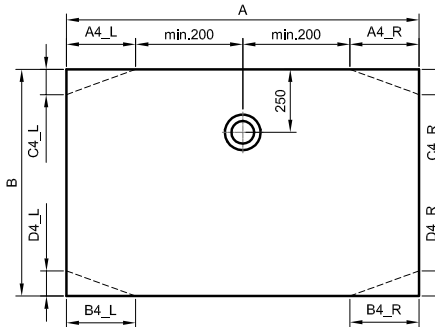

Option 4

	max. (A/2)-200mm
A4_L [mm]	
A4_R [mm]	
B4_L [mm]	
B4_R [mm]	
	max. 100mm
C4_L [mm]	
C4_R [mm]	
	max. 150mm
D4_L [mm]	
D4_R [mm]	

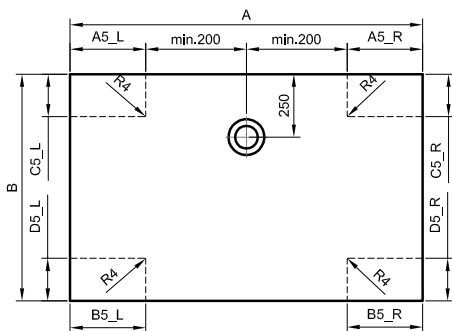

Option 5



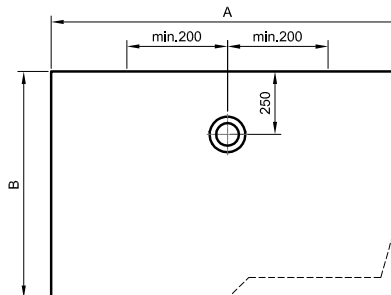











	max. A/3
A5_L [mm]	
B5_L [mm]	
	max. A/3
A5_R [mm]	
B5_R [mm]	
	max. (B/2)-200mm
C5_L [mm]	
D5_L [mm]	
	max. B/3
C5_R [mm]	
D5_R [mm]	



Option 6

Special requirements
-< mark and quote the cuts in the image



Tuš kadi Tuš kade		kolpa·san®		
Model	Naziv in dimenzija izdelka Naziv i dimenzije produkta	Opis Opis	EAN koda EAN koda	Cena EUR Cijena EUR
Dodatki za tuš kadi Dodaci za tuš kade				
	Sifon Ø 52 s pokrovom H=65 mm	Pretok: 52 l/min Protok: 52 l/min TRIN, DIXIE, ONTEX	3838987 512981	15,00
	Sifon Ø 52 brez pokrova H=65 mm	Pretok: 52 l/min Protok: 52 l/min STILETTO, DROP, LAVOLTA, RAMONA	3838987 563174	13,00
	Sifon Ø 90 s pokrovom H=65 mm	Pretok: 37 l/min Protok: 37 l/min FLAMENCO, CANARY, MALUR, MACARENA, REWALK, EVELIN	3838987 519904	25,00
	Sifon Ø 90 s pokrovom H=84 mm	Pretok: 43 l/min Protok: 43 l/min FLAMENCO, CANARY, MALUR, MACARENA, REWALK, EVELIN	3838987 925873	16,00
	Sifon Ø 90 brez pokrova H=65 mm	Pretok: 37 l/min Protok: 37 l/min BALLO, LIMBO, CAPO, SERRA, PANDORA, ACRO, MOONWALK	3838987 563181	18,00
	Sifon Ø 90 brez pokrova H=84 mm	Pretok: 43 l/min Protok: 43 l/min BALLO, LIMBO, ACRO, CAPO, PANDORA, SERRA, MOONWALK	3838987 927723	15,00
 9 x	Podnožje tuš kadi LM	Podnožje tuš kadi LM, (9 nogic) Podnožje za tuš kade LM, (9 nožica)	3838987 563150	35,00
 12 x	Podnožje tuš kadi RE-WALK	Podnožje tuš kadi RE-WALK, (12 nogic) Podnožje za tuš kade RE-WALK, (12 nožica)	3838987 563167	45,00
	Zidni montažni set Zidni montažni set	za kopalne in tuš kadi za vgradnjo za kupaonske i tuš kade za ugradnju	3838987 704362	11,00
	Suhomontažna zaključna letva Završna letva u sistemu suhe montaže	karton 25 kosov / karton 25 komada (Cena za kos / Cijena na komad 30,60 EUR)	3838987 903116	765,00
	ANTI-SLIP PREMAZ	protizdrsni premaz za tuš kadi protiv sklizni premaz za tuš kade (min. kol. 10 kos)		67,00
	Specialno čistoilo KOLPA SAN Specialno sredstvo za čišćenje	krt = 20 x 0,5 l (Cena za kos / Cijena na komad 6,20 EUR)	3838987 747291	124,00
	Specialno čistoilo ECO SAN Specijalno sredstvo	krt = 20 x 0,5 l (Cena za kos / Cijena na komad 5,40 EUR)	3838987 572220	108,00
	KERIL - Specialno čistoilo za KERROCK KERIL - Specijalno sredstvo * tuš kad LEROCK ZERO, LAVOLTA	krt = 12 x 0,5 l (Cena za kos / Cijena na komad 4,30 EUR)	3838987 747307	51,60



Tuš kabine

Tuš kabine

POLARIS 148 POLARIS FOLD 151 ANDROMEDA 153 ATLAS 155

CALYPSO 158 VIRGO 160 MONTES 161 DORSA 163 PULSAR 164

SQ LINE 166 LUNA 171 ECO QUAT 173

Krilni zasloni za kopalne kadi

Paravani za kupaonske kade

POLARIS 175 ANDROMEDA 175 SOLE 176 QUAT 176

Re Wall - Kerrock stena

Re Wall - stijena od Kerrocka

RE-WALL 178

Q kvadratna / kvadratna (TKK)

R polkrožna / polukružna (TKP)

N niša / niša (TV/S)

D vrata / vrata (TV)

W stena / stijena (TSv)

WO wall open / wall open (TS)

WIN walk in / walk in

BS krilni zaslon / paravan (TP)

STEKLA / STAKLA

1 kaljeno prozorno / kaljeno prozirno

2 chinchilla steklo / staklo

3 graphite steklo / graphite staklo

4 frost steklo / frost staklo

PROFILI / PROFILI

B black / black

SBR silver brill / silver brill

S silver / silver

WH white / white

Slike so simbolične. Pravilna razporeditev elementov je v TEHNIČNEM KATALOGU na www.kolpasan.si

Slike su simbolične. Tačan raspored elemenata je u TEHNIČKOM KATALOGU na www.kolpasan.hr

POSEBNE IZVEDBE tuš kabin, vrat, sten in zaslonov izven standardnih dimenzij:

- program DORSA, ATLAS, PULSAR, SQ-LINE, LUNA – 40% dražje od cene po ceniku
 - program POLARIS, POLARIS FOLD, ANDROMEDA, CALYPSO – 20% dražje od cene po ceniku.
- Za večja odstopanja se izdelava posebna ponudba.

POSEBNE IZVEDBE tuš kabina, vrata, stranica i zasloni van standardnih dimenzija:

- program DORSA, ATLAS, PULSAR, SQ-LINE, LUNA - 40% skuplje od cijene navedene u cjeniku
 - program POLARIS, POLARIS FOLD, ANDROMEDA, CALYPSO – 20% skuplje od cijene navedene u cjeniku.
- Za veća odstupanja izrađuje se posebna ponuda.



Konfigurator
tuš kabin
posebnih
dimenzij

5







let garancije
godina jamstva







3

leta garancije
godina jamstva

SQ line in Eco Quat
SQ line i Eco Quat









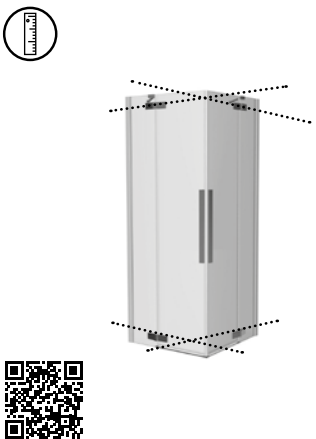





Tuš kabine Tuš kabine	Program: POLARIS Silver brill in black profili, H=200,		Silver brill in black profili. Kaljeno prozorno steklo(K), deblina stekla 8/6 mm, CLEAN COAT. Silver Brill i black profili. Kaljeno prozorno staklo(K), debljina stakla 8/6 mm, CLEAN COAT.		
Model	Naziv in dimenzija izdelka Naziv i dimenzije produkta	Opis Opis	EAN koda EAN koda	Cena EUR Cijena EUR	
Q 100, 90, 80 SBR, B/1					
	Q 100 SBR/1	tuš kabina - kotna	3838987 515333	1.044,00	
	Q 90 SBR/1	Silver brill	3838987 515326	995,00	
	Q 80 SBR/1		CLEAN COAT premaz	3838987 515319	973,00
	Q 100 B/1		tuš kabina - kotna	3838987 515364	1.097,00
	Q 90 B/1	Black	tuš kabina - kutna	3838987 515357	1.045,00
	Q 80 B/1		CLEAN COAT premaz	3838987 515340	1.021,00
R 100, 90 SBR, B/1					
	R 100 SBR/1	tuš kabina - polkrožna	3838987 515388	963,00	
	R 90 SBR/1	Silver brill	3838987 515371	933,00	
	R 100 B/1		tuš kabina - polkrožna	3838987 515401	1.011,00
	R 90 B/1	Black	tuš kabina - polukružna	3838987 515395	980,00
CLEAN COAT premaz		tuš kabina - polukružna	3838987 515395	980,00	
N 140, 120 -L SBR, B/1					
	N 140 -L SBR/1	samostojna tuš vrata - leva	3838987 515937	689,00	
	N 120 -L SBR/1	Silver brill	samostoječa tuš vrata - lijeva	3838987 515913	
	N 140 -L B/1		CLEAN COAT premaz	3838987 515913	632,00
	N 120 -L B/1	Black	samostojna tuš vrata - leva	3838987 516019	723,00
samostoječa tuš vrata - lijeva		CLEAN COAT premaz	3838987 515999	664,00	
N 140, 120 -R SBR, B/1					
	N 140 -R SBR/1	samostojna tuš vrata - desna	3838987 515944	689,00	
	N 120 -R SBR/1	Silver brill	samostoječa tuš vrata - desna	3838987 515920	
	N 140 -R B/1		CLEAN COAT premaz	3838987 515920	632,00
	N 120 -R B/1	Black	samostojna tuš vrata - desna	3838987 516088	723,00
samostoječa tuš vrata - desna		CLEAN COAT premaz	3838987 516002	664,00	
N 100, 90 -L SBR, B/1					
	N 100 -L SBR/1	samostojna tuš vrata - leva	3838987 515890	609,00	
	N 90 -L SBR/1	Silver brill	samostoječa tuš vrata - lijeva	3838987 515876	
	N 100 -L B/1		CLEAN COAT premaz	3838987 515876	589,00
	N 90 -L B/1	Black	samostojna tuš vrata - leva	3838987 515975	639,00
samostoječa tuš vrata - lijeva		CLEAN COAT premaz	3838987 515951	618,00	

Tuš kabine Tuš kabine	Program: POLARIS Silver brill in black profili, H=200,		Silver brill in black profili. Kaljeno prozorno steklo(K), deblina stekla 8/6 mm, CLEAN COAT. Silver Brill i black profili. Kaljeno prozirno staklo(K), debljina stakla 8/6 mm, CLEAN COAT.	
Model	Naziv in dimenzija izdelka Naziv i dimenzije produkta	Opis Opis	EAN koda EAN koda	Cena EUR Cijena EUR
N 100, 90 -R SBR, B/1				
	N 100 -R SBR/1	samostojna tuš vrata - desna samostojeća tuš vrata - desna	3838987 515906	609,00
	N 90 -R SBR/1 Silver brill	CLEAN COAT premaz	3838987 515883	589,00
	N 100 -R B/1	samostojna tuš vrata - desna samostojeća tuš vrata - desna	3838987 515982	639,00
	N 90 -R B/1 Black	CLEAN COAT premaz	3838987 515968	618,00
D 140, 120, 100 -L SBR, B/1				
	D 140 -L SBR/1	tuš vrata - leva tuš vrata - lijeva	3838987 515692	663,00
	D 120 -L SBR/1 Silver brill	CLEAN COAT premaz	3838987 515678	636,00
	D 100 -L SBR/1		3838987 515456	593,00
	D 140 -L B/1	tuš vrata - leva tuš vrata - lijeva	3838987 515821	697,00
	D 120 -L B/1 Black	CLEAN COAT premaz	3838987 515807	668,00
	D 100 -L B/1		3838987 515784	623,00
D 140, 120, 100 -R SBR, B/1				
	D 140 -R SBR/1	tuš vrata - desna tuš vrata - desna	3838987 515708	663,00
	D 120 -R SBR/1 Silver brill	CLEAN COAT premaz	3838987 515685	636,00
	D 100 -R SBR/1		3838987 515463	593,00
	D 140 -R B/1	tuš vrata - desna tuš vrata - desna	3838987 515838	697,00
	D 120 -R B/1 Black	CLEAN COAT premaz	3838987 515814	668,00
	D 100 -R B/1		3838987 515791	623,00
D 90, 80 -L SBR, B/1				
	D 90 -L SBR/1	tuš vrata - leva tuš vrata - lijeva	3838987 515432	574,00
	D 80 -L SBR/1 Silver brill	CLEAN COAT premaz	3838987 515418	560,00
	D 90 -L B/1	tuš vrata - leva tuš vrata - lijeva	3838987 515760	602,00
	D 80 -L B/1 Black	CLEAN COAT premaz	3838987 515746	587,00
D 90, 80 -R SBR, B/1				
	D 90 -R SBR/1	tuš vrata - desna tuš vrata - desna	3838987 515449	574,00
	D 80 -R SBR/1 Silver brill	CLEAN COAT premaz	3838987 515425	560,00
	D 90 -R B/1	tuš vrata - desna tuš vrata - desna	3838987 515777	602,00
	D 80 -R B/1 Black	CLEAN COAT premaz	3838987 515753	587,00







Tuš kabine Tuš kabine	Program: POLARIS Silver brill in black profili, H=200,		Silver brill in black profili. Kaljeno prozorno steklo(K), debelina stekla 8/6 mm, CLEAN COAT. Silver Brill i black profili. Kaljeno prozorno staklo(K), debljina stakla 8/6 mm, CLEAN COAT.		kolpa-san®
Model	Naziv in dimenzija izdelka Naziv i dimenzije produkta	Opis Opis	EAN koda EAN koda	Cena EUR Cijena EUR	
W 100, 90, 80 SBR, B/1					
	W 100 SBR/1	Silver brill	tuš stena (kombinacija z D) tuš stena (kombinacija s D)	3838987 515739	266,00
	W 90 SBR/1		CLEAN COAT premaz	3838987 515722	242,00
	W 80 SBR/1		debelina stekla/debljina stakla 8 mm	3838987 515715	223,00
	W 100 B/1	Black	tuš stena (kombinacija z D) tuš stena (kombinacija s D)	3838987 515869	279,00
	W 90 B/1		CLEAN COAT premaz	3838987 515852	254,00
	W 80 B/1		debelina stekla/debljina stakla 8 mm	3838987 515845	233,00
POS. DIM. Q, R, N, D, W SBR, B/1					
	Q SBR/1	Silver brill	Posebne dimenzije Posebne dimenzije	3838987 400110	
	R SBR/1		3838987 400134		
	N SBR/1		3838987 400196		
	D SBR/1		3838987 400158		
	W SBR/1		3838987 400165		
	Q B/1	Black	Posebne dimenzije Posebne dimenzije	3838987 400127	
	R B/1		3838987 400141		
	N B/1		3838987 400202		
	D B/1		3838987 400172		
	W B/1		3838987 400189		





Dodatki / Dodaci POLARIS					
	SDL	sedež za tuš kabino - višinsko nastavljiv	3838987 593935	235,00	
	STK-N	sjedalo za tuš kabino - podesiv po visini	3838987 573227	174,00	
	STK	sedež za tuš kabino z nogicama - preklopni sjedalo za tuš kabino sa nožicama - preklopni sedež za tuš kabino - preklopni sjedalo za tuš kabino - preklopni	3838987 950707	151,00	
	KS	kopalniški stolček, h=40 cm, prenosni kupaonska stolica, h=40 cm, prenosni	3838987 950608	56,00	
	Mast za ležaje in tečaje tuš kabin Mast za ležajevе i šarke tuš kabina	krt = 10 x 20 ml (Cena za kos / Cijena na komad 4,50 EUR)	3838987 994169	45,00	
	Brisalec stekla Brisač stakla	Brisalec stekla z držalom krom Brisač stakla sa kromiranim ručkom	3838987 491095	24,00	
	EL-SHOWER	Dvojna viseča odlagalna košarica za tuš kabino / Dvostruka viseća košarica za tuš kabinu	3838987 491101	98,00	
	Specialno čistilo KOLPA SAN Specialno sredstvo za čišćenje	krt = 20 x 0,5 l (Cena za kos / Cijena na komad 6,20 EUR)	3838987 747291	124,00	
	Specialno čistilo ECO SAN Specialno sredstvo za čišćenje	krt = 20 x 0,5 l (Cena za kos / Cijena na komad 5,40 EUR)	3838987 572220	108,00	

Tuš kabine Tuš kabine	Program: POLARIS FOLD Silver brill in black profili, H=200,		Silver brill in black profili. Kaljeno prozorno steklo(K), deblina stakla 6/6 mm, CLEAN COAT. Silver Brill i black profili. Kaljeno prozorno staklo(K), deblina stakla 6/6 mm, CLEAN COAT.	
Model	Naziv in dimenzija izdelka Naziv i dimenzije produkta	Opis Opis	EAN koda EAN koda	Cena EUR Cijena EUR
Q 100, 90, 80 SBR, B/1				
	Q 100 SBR/1	tuš kabina - kotna, zložljiva na notranjo ali zunanjo stran tuš kabina - kotna, zložljiva na unutarnju ili vansku stranu CLEAN COAT premaz	3838987 516118	1.193,00
	Q 90 SBR/1 Silver brill		3838987 516101	1.126,00
	Q 80 SBR/1		3838987 516095	1.086,00
	Q 100 B/1		3838987 516149	1.253,00
	Q 90 B/1 Black		3838987 516132	1.182,00
	Q 80 B/1		3838987 516125	1.141,00
N 100, 90, 80 -L SBR, B/1				
	N 100 -L SBR/1	samostojna tuš vrata - leva, zložljiva na notranjo ali zunanjo stran samostojeća tuš vrata - lijeva, zložljiva na unutarnju ili vansku stranu CLEAN COAT premaz	3838987 516378	657,00
	N 90 -L SBR/1 Silver brill		3838987 516354	623,00
	N 80 -L SBR/1		3838987 516330	610,00
	N 100 -L B/1		3838987 516439	690,00
	N 90 -L B/1 Black		3838987 516415	654,00
N 80 -L B/1	3838987 516392	641,00		
N 100, 90, 80 -R SBR, B/1				
	N 100 -R SBR/1	samostojna tuš vrata - desna, zložljiva na notranjo ali zunanjo stran samostojeća tuš vrata - desna, zložljiva na unutarnju ili vansku stranu CLEAN COAT premaz	3838987 516385	657,00
	N 90 -R SBR/1 Silver brill		3838987 516361	623,00
	N 80 -R SBR/1		3838987 516347	610,00
	N 100 -R B/1		3838987 516446	690,00
	N 90 -R B/1 Black		3838987 516422	654,00
N 80 -R B/1	3838987 516408	641,00		
D 100, 90, 80 -L SBR, B/1				
	D 100 -L SBR/1	tuš vrata - leva, zložljiva na notranjo ali zunanjo stran tuš vrata - lijeva, zložljiva na unutarnju ili vansku stranu CLEAN COAT premaz	3838987 516194	658,00
	D 90 -L SBR/1 Silver brill		3838987 516170	636,00
	D 80 -L SBR/1		3838987 516156	623,00
	D 100 -L B/1		3838987 516286	691,00
	D 90 -L B/1 Black		3838987 516262	668,00
	D 80 -L B/1		3838987 516248	654,00
D 100, 90, 80 -R SBR, B/1				
	D 100 -R SBR/1	tuš vrata - desna, zložljiva na notranjo ali zunanjo stran tuš vrata - desna, zložljiva na unutarnju ili vansku stranu CLEAN COAT premaz	3838987 516200	658,00
	D 90 -R SBR/1 Silver brill		3838987 516187	636,00
	D 80 -R SBR/1		3838987 516163	623,00
	D 100 -R B/1		3838987 516293	691,00
	D 90 -R B/1 Black		3838987 516279	668,00
	D 80 -R B/1		3838987 516255	654,00



Tuš kabine Tuš kabine	Program: POLARIS FOLD Silver brill in black profili, H=200,		Silver brill in black profili. Kaljeno prozorno steklo(K), debelina stekla 6/6 mm, CLEAN COAT. Silver Brill i black profili. Kaljeno prozorno staklo(K), debljina stakla 8/6 mm, CLEAN COAT.	kolpa-san®	
Model	Naziv in dimenzija izdelka Naziv i dimenzije produkta	Opis Opis	EAN koda EAN koda	Cena EUR Cijena EUR	
W 100, 90, 80 SBR, B/1					
	W 100 SBR/1	Silver brill	tuš stena (kombinacija z D)	3838987 515739	266,00
	W 90 SBR/1		tuš stena (kombinacija s D)	3838987 515722	242,00
	W 80 SBR/1		CLEAN COAT premaz	3838987 515715	223,00
		Black	debelina stekla/debljina stakla 8 mm	3838987 515869	279,00
	W 100 B/1		tuš stena (kombinacija z D)	3838987 515852	254,00
	W 90 B/1		CLEAN COAT premaz	3838987 515845	233,00
W 80 B/1	debelina stekla/debljina stakla 8 mm				
POS. DIM. Q, N, D, W SBR, B/1					
 	Q SBR/1	Silver brill	Posebne dimenzije	3838987 400219	
	N SBR/1		Posebne dimenzije	3838987 400257	
	D SBR/1			3838987 400233	
	W SBR/1			3838987 400165	
	Q B/1	Black	Posebne dimenzije	3838987 400226	
	N B/1		Posebne dimenzije	3838987 400264	
	D B/1			3838987 400240	
	W B/1			3838987 400189	

Dodatki / Dodaci POLARIS FOLD				
	SDL	sedež za tuš kabino - višinsko nastavljiv	3838987 593935	235,00
	STK-N	sjedalo za tuš kabino - podesiv po visini	3838987 573227	174,00
	STK	sedež za tuš kabino z nogicama - preklopni	3838987 950707	151,00
		sjedalo za tuš kabino sa nožicama - preklopni		
	KS	kopalniški stolček, h=40 cm, prenosni	3838987 950608	56,00
		kupaonska stolica, h=40 cm, prenosni		
	Mast za ležaje in tečaje tuš kabin	krt = 10 x 20 ml	3838987 994169	45,00
	Mast za ležajeve i šarke tuš kabina	(Cena za kos / Cijena na komad 4,50 EUR)		
	Brisalec stekla	Brisalec stekla z držalom krom	3838987 491095	24,00
	Brisač stakla	Brisač stakla sa kromiranom ručkom		
	EL-SHOWER	Dvojna viseča odlagalna košarica za tuš kabino	3838987 491101	98,00
		Dvostruka viseća košarica za tuš kabinu		
	Specialno čištilo KOLPA SAN	krt = 20 x 0,5 l	3838987 747291	124,00
	Specialno sredstvo za čišćenje	(Cena za kos / Cijena na komad 6,20 EUR)		
	Specialno čištilo ECO SAN	krt = 20 x 0,5 l	3838987 572220	108,00
	Specialno sredstvo za čišćenje	(Cena za kos / Cijena na komad 5,40 EUR)		

Tuš kabine Tuš kabine	Program: ANDROMEDA Silver brill in black profili, H=200,		Silver brill in black profili. Kaljeno prozorno steklo(K), deblina stekla 8/6 mm, CLEAN COAT. Silver Brill i black profili. Kaljeno prozorno staklo(K), debljina stakla 8/6 mm, CLEAN COAT.	kolpa-san®
Model	Naziv in dimenzija izdelka Naziv i dimenzije produkta	Opis Opis	EAN koda EAN koda	Cena EUR Cijena EUR
Q 100, 90, 80 SBR, B/1				
	Q 100 SBR/1	tuš kabina - kotna	3838987 516477	788,00
	Q 90 SBR/1 Silver brill	tuš kabina - kutna CLEAN COAT premaz	3838987 516460	765,00
	Q 80 SBR/1		3838987 516453	742,00
	Q 100 B/1		3838987 516507	827,00
	Q 90 B/1 Black	tuš kabina - kutna CLEAN COAT premaz	3838987 516491	804,00
	Q 80 B/1		3838987 516484	779,00
N 160, 140, 120 - UNI SBR, B/1				
	N 160 -UNI SBR/1	samostojeća tuš vrata - univerzalna	3838987 516743	656,00
	N 140 -UNI SBR/1 Silver brill	samostojeća tuš vrata - univerzalna CLEAN COAT premaz	3838987 516736	620,00
	N 120 -UNI SBR/1		3838987 516729	590,00
	N 160 -UNI B/1		3838987 516804	689,00
	N 140 -UNI B/1 Black	samostojeća tuš vrata - univerzalna CLEAN COAT premaz	3838987 516798	651,00
	N 120 -UNI B/1		3838987 516781	620,00
N 100, 90, 80 - UNI SBR, B/1				
	N 100 -UNI SBR/1	samostojeća tuš vrata - univerzalna	3838987 516712	469,00
	N 90 -UNI SBR/1 Silver brill	samostojeća tuš vrata - univerzalna CLEAN COAT premaz	3838987 516705	444,00
	N 80 -UNI SBR/1		3838987 516699	427,00
	N 100 -UNI B/1		3838987 516774	492,00
	N 90 -UNI B/1 Black	samostojeća tuš vrata - univerzalna CLEAN COAT premaz	3838987 516767	467,00
	N 80 -UNI B/1		3838987 516750	448,00
D 160, 140, 120 - UNI SBR, B/1				
	D 160 -UNI SBR/1	tuš vrata - univerzalna	3838987 516569	633,00
	D 140 -UNI SBR/1 Silver brill	tuš vrata - univerzalna CLEAN COAT premaz	3838987 516552	602,00
	D 120 -UNI SBR/1		3838987 516545	574,00
	D 160 -UNI B/1		3838987 516651	666,00
	D 140 -UNI B/1 Black	tuš vrata - univerzalna CLEAN COAT premaz	3838987 516644	632,00
	D 120 -UNI B/1		3838987 516637	602,00
D 100, 90, 80 - UNI SBR, B/1				
	D 100 -UNI SBR/1	tuš vrata - univerzalna	3838987 516538	487,00
	D 90 -UNI SBR/1 Silver brill	tuš vrata - univerzalna CLEAN COAT premaz	3838987 516521	462,00
	D 80 -UNI SBR/1		3838987 516514	446,00
	D 100 -UNI B/1		3838987 516620	511,00
	D 90 -UNI B/1 Black	tuš vrata - univerzalna CLEAN COAT premaz	3838987 516613	486,00
	D 80 -UNI B/1		3838987 516606	469,00

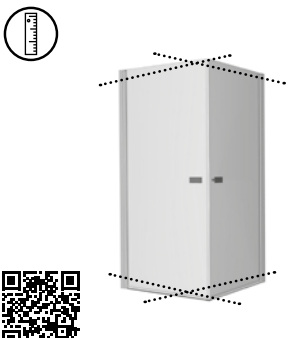

Tuš kabine Tuš kabine	Program: ANDROMEDA Silver brill in black profili, H=200,	Silver brill in black profili. Kaljeno prozorno steklo(K), deblina stakla 8/6 mm, CLEAN COAT. Silver Brill i black profili. Kaljeno prozirno staklo(K), deblina stakla 8/6 mm, CLEAN COAT.	kolpa-san®		
Model	Naziv in dimenzija izdelka Naziv i dimenzije produkta	Opis Opis	EAN koda EAN koda	Cena EUR Cijena EUR	
W 100, 90, 80 SBR, B/1					
	W 100 SBR/1	tuš stena (kombinacija z D) tuš stena (kombinacija s D) CLEAN COAT premaz	3838987 515739	266,00	
	W 90 SBR/1		Silver brill	3838987 515722	242,00
	W 80 SBR/1		debelina stakla/debljina stakla 8 mm	3838987 515715	223,00
	W 100 B/1	tuš stena (kombinacija z D) tuš stena (kombinacija s D) CLEAN COAT premaz	3838987 515869	279,00	
	W 90 B/1		Black	3838987 515852	254,00
	W 80 B/1		debelina stakla/debljina stakla 8 mm	3838987 515845	233,00
POS. DIM. Q, N, D, W SBR, B/1					
	Q SBR/1	Posebne dimenzije Posebne dimenzije	3838987 400271		
	N SBR/1		3838987 400318		
	D SBR/1		Silver brill	3838987 400295	
	W SBR/1		3838987 400165		
	Q B/1	Posebne dimenzije Posebne dimenzije	3838987 400288		
	N B/1		3838987 400325		
	D B/1		Black	3838987 400301	
W B/1	3838987 400189				

Dodatki / Dodaci ANDROMEDA					
	SDL	sedež za tuš kabino - višinsko nastavljiv sjedalo za tuš kabino - podesiv po visini	3838987 593935	235,00	
	STK-N		sedež za tuš kabino z nogicama - preklopni sjedalo za tuš kabino sa nožicama - preklopni	3838987 573227	174,00
	STK		sedež za tuš kabino - preklopni sjedalo za tuš kabino - preklopni	3838987 950707	151,00
	KS	kopalniški stolček, h=40 cm, prenosni kupaonska stolica, h=40 cm, prenosni	3838987 950608	56,00	
	Mast za ležaje in tečaje tuš kabin Mast za ležajeve i šarke tuš kabina	krt = 10 x 20 ml (Cena za kos / Cijena na komad 4,50 EUR)	3838987 994169	45,00	
	Brisalec stakla Brisač stakla	Brisalec stakla z držalom krom Brisač stakla sa kromiranom ručkom	3838987 491095	24,00	
	EL-SHOWER	Dvojna viseća odlagalna košarica za tuš kabino / Dvostruka viseća košarica za tuš kabinu	3838987 491101	98,00	
	Specialno čištilo KOLPA SAN Specialno sredstvo za čišćenje	krt = 20 x 0,5 l (Cena za kos / Cijena na komad 6,20 EUR)	3838987 747291	124,00	
	Specialno čištilo ECO SAN Specialno sredstvo za čišćenje	krt = 20 x 0,5 l (Cena za kos / Cijena na komad 5,40 EUR)	3838987 572220	108,00	







Tuš kabine

Tuš kabine

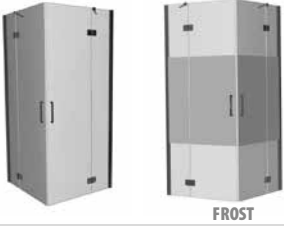



**Program: ATLAS
Silver Brill profili, H=200**









Silver Brill profili in kromirani dvizni tečajji. Kaljeno prozorno steklo(K), debelina stekla 6 mm. Silver Brill profili i kromirane podizne šarke. Kaljeno prozorno staklo(K), debljina stakla 6 mm.

kolpa-san







Model	Naziv in dimenzija izdelka Naziv i dimenzije produkta	Opis Opis	EAN koda EAN koda	Cena EUR Cijena EUR
TKK 100/K, 90/K				
	TKK 100/K	tuš kabina - kotna	3838987 560210	609,00
	TKK 90/K	tuš kabina - kutna	3838987 560203	549,00
	TKK 100/K-FROST	tuš kabina - kotna	3838987 560838	738,00
	TKK 90/K-FROST	tuš kabina - kutna FROST - neprosojni pas stekla neprozirni pojas stakla	3838987 560821	667,00
TKP 100/K, 90/K				
	TKP 100/K	tuš kabina - polkrožna	3838987 560234	616,00
	TKP 90/K	tuš kabina - polukružna	3838987 560227	553,00
	TKP 100/K-FROST	tuš kabina - polkrožna	3838987 560852	746,00
	TKP 90/K-FROST	tuš kabina - polukružna FROST - neprosojni pas stekla neprozirni pojas stakla	3838987 560845	669,00
TV/S 120/K-L				
	TV/S 120/K-L	samostojna tuš vrata - leva samostoječa tuš vrata - lijeva	3838987 560289	539,00
TV/S 100/K-L, 90/K-L				
	TV/S 100/K-L	samostojna tuš vrata - leva samostoječa tuš vrata - lijeva	3838987 560265	476,00
	TV/S 90/K-L		3838987 560241	469,00
TV/S 120/K-D				
	TV/S 120/K-D	samostojna tuš vrata - desna samostoječa tuš vrata - desna	3838987 560296	539,00
TV/S 100/K-D, 90/K-D				
	TV/S 100/K-D	samostojna tuš vrata - desna samostoječa tuš vrata - desna	3838987 560272	476,00
	TV/S 90/K-D		3838987 560258	469,00









Tuš kabine
Tuš kabine

Tuš kabine Tuš kabine	Program: ATLAS Silver Brill profili, H=200		Silver Brill profili in kromirani dvižni tečajji. Kaljeno prozorno staklo(K), deblina stakla 6 mm. Silver Brill profili i kromirane podizne šarke. Kaljeno prozirno staklo(K), debljina stakla 6 mm. 	
Model	Naziv in dimenzija izdelka Naziv i dimenzije produkta	Opis Opis	EAN koda EAN koda	Cena EUR Cijena EUR
TV 120/K-L, 100/K-L, 90/K-L				
	TV 120/K-L TV 100/K-L TV 90/K-L	tuš vrata - leva (kombinacija s TSv) tuš vrata - lijeva (kombinacija s TSv)	3838987 560340 3838987 560326 3838987 560302	515,00 496,00 484,00
TV 120/K-D, 100/K-D, 90/K-D				
	TV 120/K-D TV 100/K-D TV 90/K-D	tuš vrata - desna (kombinacija s TSv) tuš vrata - desna (kombinacija s TSv)	3838987 560357 3838987 560333 3838987 560319	515,00 496,00 484,00
TSv 90K, 80/K				
	TSv 90/K TSv 80/K	tuš stena (kombinacija s TV) tuš stena (kombinacija s TV)	3838987 560371 3838987 560364	165,00 160,00
POS. DIM. TKK, TVS, TV, TSV-BRILL/K				
	TKK BRILL/K TVS BRILL/K TV BRILL/K TSV BRILL/K	Posebne dimenzije Posebne dimenzije	3838987 400431 3838987 400448 3838987 400455 3838987 400462	











Tuš kabine Tuš kabine	Program: ATLAS Silver Brill profili, H=200		Silver Brill profili in kromirani dvizni tečajji. Kaljeno prozorno staklo(K), debelina stakla 6 mm. Silver Brill profili i kromirane podizne šarke. Kaljeno prozorno staklo(K), debljina stakla 6 mm.	
Model	Naziv in dimenzija izdelka Naziv i dimenzije produkta	Opis Opis	EAN koda EAN koda	Cena EUR Cijena EUR
Dodatki / Dodaci ATLAS				
 <p>SDL</p> <p>STK-N</p>  <p>STK</p>	SDL STK-N STK	sedež za tuš kabino - višinsko nastavljiv sjedalo za tuš kabino - podesiv po visini sedež za tuš kabino z nogicami - preklopni sjedalo za tuš kabino sa nožicama - preklopni sedež za tuš kabino - preklopni sjedalo za tuš kabino - preklopni	3838987 593935 3838987 573227 3838987 950707	235,00 174,00 151,00
	KS	kopalniški stolček, h=40 cm, prenosni kupaonska stolica, h=40 cm, prenosni	3838987 950608	56,00
	Mast za ležaje in tečaje tuš kabin Mast za ležajeve i šarke tuš kabina	krt = 10 x 20 ml (Cena za kos / Cijena na komad 4,50 EUR)	3838987 994169	45,00
	Brisalec stekla Brisač stakla	Brisalec stekla z držalom krom Brisač stakla sa kromiranom ručkom	3838987 491095	24,00
	EL-SHOWER	Dvojna viseča odlagalna košarica za tuš kabino / Dvostruka viseća košarica za tuš kabinu	3838987 491101	98,00
	Specialno čistilo KOLPA SAN Specialno sredstvo za čiščenje Specialno čistilo ECO SAN Specialno sredstvo za čiščenje	krt = 20 x 0,5 l (Cena za kos / Cijena na komad 6,20 EUR) krt = 20 x 0,5 l (Cena za kos / Cijena na komad 5,40 EUR)	3838987 747291 3838987 572220	124,00 108,00



Tuš kabine Tuš kabine	Program: CALYPSO Silver brill in black profili, H=200,		Silver brill in black profili. Kaljeno prozorno (/1) in GRAPHITE steklo (/3), debelina stekla 8 mm, CLEAN COAT. Silver Brill i black profili. Kaljeno prozirno (/1) i GRAPHITE staklo (/3), debljina stakla 8 mm, CLEAN COAT.		
Model	Naziv in dimenzija izdelka Naziv i dimenzije produkta	Opis Opis	EAN koda EAN koda	Cena EUR Cijena EUR	
WO 140, 120, 100-UNI SBR, B/1					
	WO 140-UNI SBR/1	tuš stena - open	3838987 517566	389,00	
	WO 120-UNI SBR/1 Silver brill	tuš stijenka CLEAN COAT premaz	3838987 517559	355,00	
	WO 100-UNI SBR/1		3838987 517542	326,00	
	WO 140-UNI B/1		3838987 517603	409,00	
	WO 120-UNI B/1 Black	tuš stijenka CLEAN COAT premaz	3838987 517597	373,00	
	WO 100-UNI B/1		3838987 517580	342,00	
WO 140, 120, 100-UNI SBR, B/3					
	WO 140-UNI SBR/3	tuš stena - GRAPHITE steklo	3838987 517832	418,00	
	WO 120-UNI SBR/3 Silver brill	tuš stijenka - GRAPHITE staklo CLEAN COAT premaz	3838987 517825	376,00	
	WO 100-UNI SBR/3		3838987 517818	341,00	
	WO 140-UNI B/3		3838987 517863	440,00	
	WO 120-UNI B/3 Black	tuš stijenka - GRAPHITE staklo CLEAN COAT premaz	3838987 517856	395,00	
	WO 100-UNI B/3		3838987 517849	358,00	
WIN 160-UNI SBR, B/1					
	WIN 160x100-UNI SBR/1	tuš kabina	3838987 517665	568,00	
	WIN 160x90-UNI SBR/1 Silver brill	tuš kabina CLEAN COAT premaz	3838987 517658	551,00	
	WIN 160x80-UNI SBR/1		3838987 517641	537,00	
	WIN 160x100-UNI B/1		3838987 517726	597,00	
	WIN 160x90-UNI B/1 Black	tuš kabina CLEAN COAT premaz	3838987 517719	579,00	
	WIN 160x80-UNI B/1		3838987 517702	564,00	
WIN 140-UNI SBR, B/1					
	WIN 140x100-UNI SBR/1	tuš kabina	3838987 517634	542,00	
	WIN 140x90-UNI SBR/1 Silver brill	tuš kabina CLEAN COAT premaz	3838987 517627	524,00	
	WIN 140x80-UNI SBR/1		3838987 517610	508,00	
	WIN 140x100-UNI B/1		3838987 517696	569,00	
	WIN 140x90-UNI B/1 Black	tuš kabina CLEAN COAT premaz	3838987 517689	551,00	
	WIN 140x80-UNI B/1		3838987 517672	534,00	
POS. DIM. WO, WIN SBR, B/1					
 	WO SBR/1	Posebne dimenzije	3838987 400332		
	WIN SBR/1	Posebne dimenzije	3838987 400356		
	WO B/1	Posebne dimenzije	3838987 400349		
	WIN B/1	Posebne dimenzije	3838987 400363		

Tuš kabine Tuš kabine	Program: CALYPSO Silver brill in black profili, H=200,		Silver brill in black profili. Kaljeno prozorno (1) in dimljeno steklo GRAPHITE (3), debelina stakla 8 mm, CLEAN COAT. Silver Brill i black profili. <small>Kaljeno prozorno (1) i GRAPHITE dimljeno staklo (3), debljina stakla 8 mm, CLEAN COAT.</small>		
Model	Naziv in dimenzija izdelka <small>Naziv i dimenzije produkta</small>	Opis <small>Opis</small>	EAN koda <small>EAN koda</small>	Cena EUR <small>Cijena EUR</small>	
Dodatki / Dodaci CALYPSO					
 <p>SDL</p> <p>STK-N</p>  <p>STK</p>	SDL STK-N STK	sedež za tuš kabino - višinsko nastavljiv <small>sjedalo za tuš kabino - podesiv po visini</small> sedež za tuš kabino z nogicama - preklopni <small>sjedalo za tuš kabino sa nožicama - preklopni</small> sedež za tuš kabino - preklopni <small>sjedalo za tuš kabino - preklopni</small>	3838987 593935 3838987 573227 3838987 950707	235,00 174,00 151,00	
	KS	kopalniški stolček, h=40 cm, prenosni <small>kupaonska stolica, h=40 cm, prenosni</small>	3838987 950608	56,00	
	Mast za ležaje in tečaje tuš kabin <small>Mast za ležajevе i šarke tuš kabina</small>	krt = 10 x 20 ml <small>(Cena za kos / Cijena na komad 4,50 EUR)</small>	3838987 994169	45,00	
	Brisalec stekla <small>Brisač stakla</small>	Brisalec stekla z držalom krom <small>Brisač stakla sa kromiranom ručkom</small>	3838987 491095	24,00	
	EL-SHOWER	Dvojna viseča odlagalna košarica za tuš kabino <small>Dvostruka viseća košarica za tuš kabinu</small>	3838987 491101	98,00	
	Specialno čistilo KOLPA SAN <small>Specialno sredstvo za čišćenje</small> Specialno čistilo ECO SAN <small>Specialno sredstvo za čišćenje</small>	krt = 20 x 0,5 l <small>(Cena za kos / Cijena na komad 6,20 EUR)</small> krt = 20 x 0,5 l <small>(Cena za kos / Cijena na komad 5,40 EUR)</small>	3838987 747291 3838987 572220	124,00 108,00	



Tuš kabine Tuš kabine	Program: VIRGO UNI Silver Brill profili, H=200		Silver Brill profili. Kaljeno prozorno staklo(K), debelina stakla 8 mm, CLEAN COAT. / Silver Brill profili. Kaljeno prozirno staklo(K), debljina stakla 8 mm, CLEAN COAT.	kolpa-san
Model	Naziv in dimenzija izdelka Naziv i dimenzije produkta	Opis Opis	EAN koda EAN koda	Cena EUR Cijena EUR
TK 160x90/K, 160x80/K, 140x90/K, 140x80/K, 120x90/K, 120x80/K UNI				
	TK 160x90/K -UNI TK 160x80/K -UNI TK 140x90/K -UNI TK 140x80/K -UNI TK 120x90/K -UNI TK 120x80/K -UNI	tuš kabina, kotna tuš kabina, kutna UNIVERZALNA CLEAN COAT premaz	3838987 513223 3838987 513193 3838987 513216 3838987 513186 3838987 513209 3838987 513179	696,00 686,00 681,00 670,00 658,00 652,00
TV2D/S 160/K, 140/K, 120/K UNI				
	TV2D/S 160/K -UNI TV2D/S 140/K -UNI TV2D/S 120/K -UNI	samostojna tuš vrata samostojeća tuš vrata UNIVERZALNA CLEAN COAT premaz	3838987 513162 3838987 513155 3838987 513148	595,00 578,00 556,00
	Program: VIRGO UNI BLACK profili, H=200	BLACK (črni) profili. Kaljeno prozorno staklo(K), debelina stakla 8 mm. BLACK (crni) profili. Kaljeno prozirno staklo(K), debljina stakla 8 mm.		
TK 120x90/K, 120x80/K UNI				
	TK 120x90/K BLACK -UNI TK 120x80/K BLACK -UNI	tuš kabina, kotna tuš kabina, kutna UNIVERZALNA CLEAN COAT premaz	3838987 513131 3838987 512950	684,00 679,00
Dodatki / Dodaci VIRGO				
SDL  STK-N  STK 	SDL STK-N STK	sedež za tuš kabino - višinsko nastavljiv sjedalo za tuš kabino - podešiv po visini sedež za tuš kabino z nogicama - preklopni sjedalo za tuš kabino sa nožicama - preklopni sedež za tuš kabino - preklopni sjedalo za tuš kabino - preklopni	3838987 593935 3838987 573227 3838987 950707	235,00 174,00 151,00
	KS	kopalniški stolček, h=40 cm, prenosni kupaonska stolica, h=40 cm, prenosni	3838987 950608	56,00
	Mast za ležaje in tečaje tuš kabin Mast za ležajeve i šarke tuš kabina	krt = 10 x 20 ml (Cena za kos / Cijena na komad 4,50 EUR)	3838987 994169	45,00
	Brisalec stekla Brisač stakla	Brisalec stekla z držalom krom Brisač stakla sa kromiranom ručkom	3838987 491095	24,00
	EL-SHOWER	Dvojna viseča odlagalna košarica za tuš kabino / Dvostruka viseća košarica za tuš kabinu	3838987 491101	98,00
	Specialno čistilo KOLPA SAN Specialno sredstvo za čišćenje Specialno čistilo ECO SAN Specialno sredstvo za čišćenje	krt = 20 x 0,5 l (Cena za kos / Cijena na komad 6,20 EUR) krt = 20 x 0,5 l (Cena za kos / Cijena na komad 5,40 EUR)	3838987 747291 3838987 572220	124,00 108,00
160	www.kolpa.si	www.kolpa.hr		





Tuš kabine

Tuš kabine

Program: MONTES
Silver Brill profili, H=200









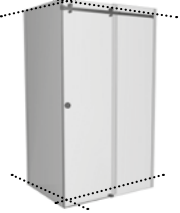

Silver Brill profili. Kaljeno prozorno staklo(K), deblina stakla 8 mm, CLEAN COAT. / Silver Brill profili. Kaljeno prozorno staklo(K), deblina stakla 8 mm, CLEAN COAT.

kolpa-san







Model	Naziv in dimenzija izdelka Naziv i dimenzije produkta	Opis Opis	EAN koda EAN koda	Cena EUR Cijena EUR
TK 140x90/K, 140x80/K, 120x90/K, 120x80/K-L CL. C				
	TK 140x90/K-L	tuš kabina, kotna - leva tuš kabina, kutna - lijeva	3838987514411	715,00
	TK 140x80/K-L	CLEAN COAT premaz	3838987 514398	702,00
	TK 120x90/K-L		3838987 514374	674,00
	TK 120x80/K-L		3838987 514435	663,00
TK 140x90/K, 140x80/K, 120x90/K, 120x80/K-D CL. C				
	TK 140x90/K-D	tuš kabina, kotna - desna tuš kabina, kutna - desna	3838987 514404	715,00
	TK 140x80/K-D	CLEAN COAT premaz	3838987 514381	702,00
	TK 120x90/K-D		3838987 512912	674,00
	TK 120x80/K-D		3838987 514428	663,00
TV2D/S 140/K, 120/K-L CL. C				
	TV2D/S 140/K-L	samostojna tuš vrata - leva samostojeća tuš vrata - leva	3838987 514473	609,00
	TV2D/S 120/K-L	CLEAN COAT premaz	3838987 514459	575,00
TV2D/S 140/K, 120/K-D CL. C				
	TV2D/S 140/K-D	samostojna tuš vrata - desna samostojeća tuš vrata - desna	3838987 514466	609,00
	TV2D/S 120/K-D	CLEAN COAT premaz	3838987 514442	575,00

Tuš kabine
Tuš kabine

Tuš kabine Tuš kabine	Program: MONTES Silver Brill profili, H=200		Silver Brill profili. Kaljeno prozorno staklo(K), debelina stekla 8 mm. Silver Brill profili. Kaljeno prozorno staklo(K),debljina stakla 8 mm.	
Model	Naziv in dimenzija izdelka Naziv i dimenzije produkta	Opis Opis	EAN koda EAN koda	Cena EUR Cijena EUR
Dodatki / Dodaci MONTES				
	SDL STK-N STK	sedež za tuš kabino - višinsko nastavljiv sjedalo za tuš kabino - podesiv po visini sedež za tuš kabino z nogicama - preklopni sjedalo za tuš kabino sa nožicama - preklopni sedež za tuš kabino - preklopni sjedalo za tuš kabino - preklopni	3838987 593935 3838987 573227 3838987 950707	235,00 174,00 151,00
	KS	kopalniški stolček, h=40 cm, prenosni kupaonska stolica, h=40 cm, prenosni	3838987 950608	56,00
	Mast za ležaje in tečaje tuš kabin Mast za ležajeve i šarke tuš kabina	krt = 10 x 20 ml (Cena za kos / Cijena na komad 4,50 EUR)	3838987 994169	45,00
	Brisalec stekla Brisač stakla	Brisalec stekla z držalom krom Brisač stakla sa kromiranom ručkom	3838987 491095	24,00
	Specialno čistilo KOLPA SAN Specialno sredstvo za čišćenje Specialno čistilo ECO SAN Specialno sredstvo za čišćenje	krt = 20 x 0,5 l (Cena za kos / Cijena na komad 6,20 EUR) krt = 20 x 0,5 l (Cena za kos / Cijena na komad 5,40 EUR)	3838987 747291 3838987 572220	124,00 108,00







Tuš kabine Tuš kabine		Program: DORSA UNI Silver Brill profili, H=200		Silver Brill profili. Kaljeno prozorno staklo(K), deblina stakla 8 mm, CLEAN COAT. / Silver Brill profili. Kaljeno prozirno staklo(K), deblina stakla 8 mm, CLEAN COAT.		kolpa-san	
Model	Naziv in dimenzija izdelka Naziv i dimenzije produkta	Opis Opis	EAN koda EAN koda			Cena EUR Cijena EUR	
TK 140x90/K, 140x80/K, 120x90/K, 120x80/K UNI	Vgradna mera / Ugradna mjerera						
	TK 140x90/K -UNI	137-144	tuš kabina, kotna	3838987 514008			640,00
	TK 140x80/K -UNI	137-144	tuš kabina, kutna	3838987 513995			631,00
	TK 120x90/K -UNI	117-124	UNIVERZALNA	3838987 513988			616,00
	TK 120x80/K -UNI	117-124	CLEAN COAT premaz	3838987 513971			605,00
TV2D/S 140/K, 120/K UNI	Vgradna mera / Ugradna mjerera						
	TV2D/S 140/K -UNI	137-145	samostojna tuš vrata	3838987 513964			519,00
	TV2D/S 120/K -UNI	117-125	samostojeća tuš vrata	3838987 513957			509,00
			UNIVERZALNA				
			CLEAN COAT premaz				
POS. DIM. TK, TV2D/S BRILL /K							
 	TK BRILL /K		Posebne dimenzije	3838987 400509			
	TV2D/S BRILL/K		Posebne dimenzije	3838987 400516			
Dodatki / Dodaci DORSA							
	SDL		sedež za tuš kabino - višinsko nastavljiv	3838987 593935			235,00
	STK-N		sjedalo za tuš kabino - podesiv po visini	3838987 573227			174,00
	STK		sedež za tuš kabino z nogicama - preklopni	3838987 950707			151,00
			sjedalo za tuš kabino sa nožicama - preklopni				
			sedež za tuš kabino - preklopni				
	KS		kopalniški stolček, h=40 cm, prenosni	3838987 950608			56,00
			kupaonska stolica, h=40 cm, prenosni				
	Mast za ležaje in tečaje tuš kabin Mast za ležajeve i šarke tuš kabina		krt = 10 x 20 ml	3838987 994169			45,00
			(Cena za kos / Cijena na komad 4,50 EUR)				
	Brisalec stakla Brisač stakla		Brisalec stakla z držalom krom	3838987 491095			24,00
			Brisač stakla sa kromiranom ručkom				
	EL-SHOWER		Dvojna viseća odlagalna košarica za tuš kabino	3838987 491101			98,00
			/ Dvostruka viseća košarica za tuš kabinu				
	Specialno čistilo KOLPA SAN Specialno sredstvo za čišćenje		krt = 20 x 0,5 l	3838987 747291			124,00
			(Cena za kos / Cijena na komad 6,20 EUR)				
	Specialno čistilo ECO SAN Specialno sredstvo za čišćenje		krt = 20 x 0,5 l	3838987 572220			108,00
			(Cena za kos / Cijena na komad 5,40 EUR)				
www.kolpa.hr		www.kolpa.si				163	



Tuš kabine Tuš kabine	Program: PULSAR Silver profili, H=200		Silver profili. Kaljeno prozorno steklo(K), debelina stekla 6 mm. Silver profili. Kaljeno prozorno staklo(K), debljina stakla 6 mm.	
Model	Naziv in dimenzija izdelka Naziv i dimenzije produkta	Opis Opis	EAN koda EAN koda	Cena EUR Cijena EUR
TKK/K 100, 90	SNEMLJIVI VRATNI KRILI ODVOJIVA VRATNA KRILA			
	TKK 100/K TKK 90/K	tuš kabina - kotna tuš kabina - kutna	3838987 560159 3838987 560166	451,00 435,00
TKP/K 100, 90	SNEMLJIVI VRATNI KRILI ODVOJIVA VRATNA KRILA			
	TKP 100/K TKP 90/K	tuš kabina - polkrožna tuš kabina - polukružna	3838987 560418 3838987 560388	457,00 439,00
TV2D/S 120/K, 100/K-L	SNEMLJIVI VRATNI KRILI ODVOJIVA VRATNA KRILA			
	TV2D/S 120/K-L TV2D/S 100/K-L	samostojna tuš vrata (možna kombinacija s TS) - leva samostoječa tuš vrata (možna kombinacija s TS) - lijeva	3838987 513018 3838987 512998	365,00 345,00
TV2D/S 120/K, 100/K-D	SNEMLJIVI VRATNI KRILI ODVOJIVA VRATNA KRILA			
	TV2D/S 120/K-D TV2D/S 100/K-D	samostojna tuš vrata (možna kombinacija s TS) - desna samostoječa tuš vrata (možna kombinacija s TS) - desna	3838987 513025 3838987 513001	365,00 345,00
TS 90/K, 80/K				
	TS 90/K TS 80/K	tuš stena tuš stijena (kombinacija s TKK, TKP, TV/2D)	3838987 513049 3838987 513032	152,00 143,00

Tuš kabine Tuš kabine	Program: PULSAR Silver profili, H=200	Silver profili. Kaljeno prozorno staklo(K), deblina stakla 6 mm. Silver profili. Kaljeno prozorno staklo(K), deblina stakla 6 mm.	kolpa-san	
Model	Naziv in dimenzija izdelka Naziv i dimenzije produkta	Opis Opis	EAN koda EAN koda	Cena EUR Cijena EUR
POS. DIM. TKK, TKP, TV2D/S, TS, /K				
 	TKK /K SILVER TKP /K SILVER TV2D/S /K SILVER TS /K SILVER	Posebne dimenzije Posebne dimenzije	3838987 301813 3838987 400479 3838987 400486 3838987 400493	

Dodatki / Dodaci PULSAR				
	K-25 Profil	kompensacijski profil za TKK, TKP, TV in TS / kompensacijski profil za TKK, TKP, TV i TS	3838987 513056	44,00

Dodatki / Dodaci PULSAR				
 	SDL STK-N STK	sedež za tuš kabino - višinsko nastavljiv sjedalo za tuš kabino - podesiv po visini sedež za tuš kabino z nogicama - preklopni sjedalo za tuš kabino sa nožicama - preklopni sedež za tuš kabino - preklopni sjedalo za tuš kabino - preklopni	3838987 593935 3838987 573227 3838987 950707	235,00 174,00 151,00
	KS	kopalniški stolček, h=40 cm, prenosni kupaonska stolica, h=40 cm, prenosni	3838987 950608	56,00
	Mast za ležaje in tečaje tuš kabin Mast za ležajeve i šarke tuš kabina	krt = 10 x 20 ml (Cena za kos / Cijena na komad 4,50 EUR)	3838987 994169	45,00
	Brisalec stekla Brisač stakla	Brisalec stekla z držalom krom Brisač stakla sa kromiranom ručkom	3838987 491095	24,00
	EL-SHOWER	Dvojna viseča odlagalna košarica za tuš kabino / Dvostruka viseća košarica za tuš kabinu	3838987 491101	98,00
	Specialno čištilo KOLPA SAN Specialno sredstvo za čišćenje Specialno čištilo ECO SAN Specialno sredstvo za čišćenje	krt = 20 x 0,5 l (Cena za kos / Cijena na komad 6,20 EUR) krt = 20 x 0,5 l (Cena za kos / Cijena na komad 5,40 EUR)	3838987 747291 3838987 572220	124,00 108,00







Tuš kabine

Tuš kabine

**Program: SQ line
Silver profili, H=190**

Silver profili. Kaljeno prozorno (K) in kaljeno chinchilla steklo (CH), debelina stekla 5/6 mm. Silver profili. Kaljeno prozorno (K) i kaljeno chinchilla staklo (CH), debljina stakla 5/6 mm.

kolpa-san®

Model	Naziv in dimenzija izdelka Naziv i dimenzije produkta	Opis Opis	EAN koda EAN koda	Cena EUR Cijena EUR
TKK /K, CH 120, 100, 90, 80, 75, 70	SNEMLJIVI VRATNI KRILI ODVOJIVA VRATNA KRILA			
	TKK 120x90 /K	tuš kabina - kotna	3838987 513322	433,00
	TKK 120x80 /K	tuš kabina - kutna	3838987 513315	424,00
	TKK 100 /K		3838987 511205	394,00
	TKK 100 /CH		3838987 511182	413,00
	TKK 100x90 /K		3838987 511403	387,00
	TKK 100x90 /CH		3838987 511380	408,00
	TKK 90 /K		3838987 511045	286,00
	TKK 90 /CH		3838987 511021	301,00
	TKK 100x80 /K		3838987 511328	380,00
	TKK 100x80 /CH		3838987 511304	398,00
	TKK 90x80 /K		3838987 511366	370,00
	TKK 90x80 /CH		3838987 511342	387,00
	TKK 80 /K		3838987 511007	278,00
	TKK 80 /CH		3838987 510987	292,00
	TKK 90x75 /K		3838987 511274	370,00
	TKK 90x75 /CH		3838987 511281	387,00
TKK 90x70 /K		3838987 511243	366,00	
TKK 90x70 /CH		3838987 511229	384,00	
TKK 70 /K		3838987 512660	363,00	
TKK 70 /CH		3838987 512653	380,00	
TKP /K, CH R 550 120, 100, 90, 80	SNEMLJIVI VRATNI KRILI ODVOJIVA VRATNA KRILA			
	TKP 120x90 /K R550	tuš kabina - polkrožna, asimetrična	3838987 511540	461,00
	TKP 120x90 /CH R550	tuš kabina - polukružna, asimetrična	3838987 511526	483,00
	TKP 100 /K R550	tuš kabina - polkrožna	3838987 511441	433,00
	TKP 100 /CH R550	tuš kabina - polukružna	3838987 511427	454,00
	TKP 100x80 /K R550	tuš kabina - polkrožna, asimetrična	3838987 511489	430,00
	TKP 100x80 /CH R550	tuš kabina - polukružna, asimetrična	3838987 511465	450,00
	TKP 90 /K R550	tuš kabina - polkrožna	3838987 511120	289,00
	TKP 90 /CH R550	tuš kabina - polukružna	3838987 511106	305,00
TKP 80 /K R550		3838987 511083	278,00	
TKP 80 /CH R550		3838987 511069	292,00	
TV2D/S K, CH 130, 120, 110, 100	SNEMLJIVI VRATNI KRILI ODVOJIVA VRATNA KRILA			
	TV2D/S 130 /K	samostojna tuš vrata, dvodelna (možna kombinacija s TS)	3838987 511700	342,00
	TV2D/S 130 /CH	samostoječa tuš vrata, dvodjelna	3838987 511687	359,00
	TV2D/S 120 /K	(moguća kombinacija s TS)	3838987 511663	331,00
	TV2D/S 120 /CH		3838987 511649	347,00
	TV2D/S 110 /K		3838987 511625	318,00
	TV2D/S 110 /CH		3838987 511601	336,00
	TV2D/S 100 /K		3838987 511588	307,00
	TV2D/S 100 /CH		3838987 511564	321,00
TV4D/S K, CH 170, 160, 140	SNEMLJIVI VRATNI KRILI ODVOJIVA VRATNA KRILA			
	TV4D/S 170 /K	samostojna tuš vrata, štiridelna (možna kombinacija s TS)	3838987 511823	435,00
	TV4D/S 170 /CH	samostoječa tuš vrata, četiridjelna	3838987 511809	455,00
	TV4D/S 160 /K	(moguća kombinacija s TS)	3838987 511786	424,00
	TV4D/S 160 /CH		3838987 511762	446,00
	TV4D/S 140 /K		3838987 511748	408,00
	TV4D/S 140 /CH		3838987 511724	428,00
166	www.kolpa.si	www.kolpa.hr		

Tuš kabine Tuš kabine	Program: SQ line Silver profili, H=190	Silver profili. Kaljeno prozorno (K) in kaljeno chinchilla steklo (CH), debelina stekla 5 mm. Silver profili. Kaljeno prozirno (K) i kaljeno chinchilla staklo (CH), debljina stakla 5 mm.		kolpa-san®
Model	Naziv in dimenzija izdelka Naziv i dimenzije produkta	Opis Opis	EAN koda EAN koda	Cena EUR Cijena EUR
TS /K, CH 90, 80, 75, 70				
	TS 90/K	tuš stena (kombinacija s TKK, TKP, TV/2D, TV/4D) tuš stijena (kombinacija s TKK, TKP, TV/2D, TV/4D)	3838987 527688	201,00
	TS 90/CH		3838987 527664	209,00
	TS 80/K		3838987 527640	185,00
	TS 80/CH		3838987 527626	197,00
	TS 75/K		3838987 527602	182,00
	TS 75/CH		3838987 527589	193,00
	TS 70/K		3838987 527565	180,00
TS 70/CH		3838987 527541	191,00	
Dodatki / Dodaci SQ line				
	K-30 SILVER	kompenzacijski profil za TKK, TKP, TV in TS SQ line / kompenzacijski profil za TKK, TKP, TV in TS SQ line	3838987 527442	44,00

	Program: SQ line Silver profili, H=160	Silver profili, H=160. Kaljeno chinchilla steklo (CH), debelina stekla 5/6 mm. Silver profili, H=160. Kaljeno chinchilla staklo (CH), debljina stakla 5/6 mm.		kolpa-san®
TKP 90 /CH DIXIE	SNEMLJIVI VRATNI KRILI ODVOJIVA VRATNA KRILA			
	TKP 90 /CH DIXIE R550	tuš kabina - polkrožna, za tuš kad Dixie, h=160 tuš kabina - polukružna, za tuš kadu Dixie, h=160	3838987 511502	394,00

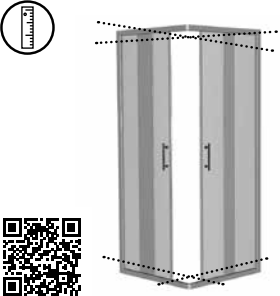
POS. DIM. TKK, TKP, TV2D/S, TV4D/S				
	TKK/K SILVER	Posebne dimenzije	3838987 512783	
	TKP/K SILVER	Posebne dimenzije	3838987 512752	
	TV2D/S/K SILVER		3838987 512790	
	TV4D/S/K SILVER		3838987 512813	
	TS/K SILVER		3838987 316749	







Tuš kabine

Tuš kabine

Program: SQ line
Beli profili, H=190

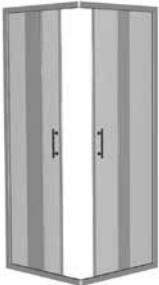
Beli profili. Kaljeno prozorno (K) in kaljeno chinchilla steklo (CH), debelina stekla 5/6 mm. Bijeli profili. Kaljeno prozorno (K) i kaljeno chinchilla staklo (CH), debljina stakla 5/6 mm.

kolpa-san®





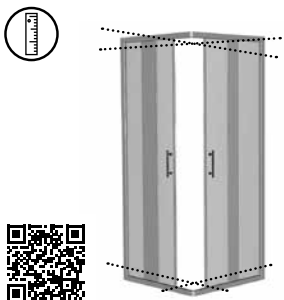

Model	Naziv in dimenzija izdelka Naziv i dimenzije produkta	Opis Opis	EAN koda EAN koda	Cena EUR Cijena EUR
TKK /K, CH 120, 100, 90, 80, 75, 70	SNEMLJIVI VRATNI KRILI ODVOJIVA VRATNA KRILA			
	TKK 120x90 /K	tuš kabina - kotna	3838987 513346	374,00
	TKK 120x80 /K	tuš kabina - kutna	3838987 513339	365,00
	TKK 100 /K		3838987 511199	348,00
	TKK 100 /CH		3838987 511175	365,00
	TKK 100x90 /K		3838987 511397	342,00
	TKK 100x90 /CH		3838987 511373	360,00
	TKK 90 /K		3838987 511038	278,00
	TKK 90 /CH		3838987 511014	292,00
	TKK 100x80 /K		3838987 511311	337,00
	TKK 100x80 /CH		3838987 511298	352,00
	TKK 90x80 /K		3838987 511359	328,00
	TKK 90x80 /CH		3838987 511335	343,00
	TKK 80 /K		3838987 510994	268,00
	TKK 80 /CH		3838987 510970	283,00
TKK 90x75 /K		3838987 511250	328,00	
TKK 90x75 /CH		3838987 511267	343,00	
TKK 90x70 /K		3838987 511236	325,00	
TKK 90x70 /CH		3838987 511212	341,00	
TKP /K, CH R 550 120, 100, 90, 80	SNEMLJIVI VRATNI KRILI ODVOJIVA VRATNA KRILA			
	TKP 120x90 /K R550	tuš kabina - polkrožna, asimetrična	3838987 511533	383,00
	TKP 120x90 /CH R550	tuš kabina - polukružna, asimetrična	3838987 511519	402,00
	TKP 100 /K R550	tuš kabina - polkrožna	3838987 511434	362,00
	TKP 100 /CH R550	tuš kabina - polukružna	3838987 511410	378,00
	TKP 100x80 /K R550	tuš kabina - polkrožna, asimetrična	3838987 511472	359,00
	TKP 100x80 /CH R550	tuš kabina - polukružna, asimetrična	3838987 511458	376,00
	TKP 90 /K R550	tuš kabina - polkrožna	3838987 511113	282,00
	TKP 90 /CH R550	tuš kabina - polukružna	3838987 511090	298,00
TKP 80 /K R550		3838987 511076	268,00	
TKP 80 /CH R550		3838987 511052	283,00	
TV2D/S K, CH 130, 120, 110, 100	SNEMLJIVI VRATNI KRILI ODVOJIVA VRATNA KRILA			
	TV2D/S 130 /K	samostojna tuš vrata, dvodelna	3838987 511694	311,00
	TV2D/S 130 /CH	(možna kombinacija s TS)	3838987 511670	326,00
	TV2D/S 120 /K	samostoječa tuš vrata, dvodjelna	3838987 511656	303,00
	TV2D/S 120 /CH	(moguća kombinacija s TS)	3838987 511632	315,00
	TV2D/S 110 /K		3838987 511618	294,00
	TV2D/S 110 /CH		3838987 511595	307,00
	TV2D/S 100 /K		3838987 511571	282,00
	TV2D/S 100 /CH		3838987 511557	295,00
TV4D/S K, CH 170, 160, 140	SNEMLJIVI VRATNI KRILI ODVOJIVA VRATNA KRILA			
	TV4D/S 170 /K	samostojna tuš vrata, štiridjelna	3838987 511816	395,00
	TV4D/S 170 /CH	(možna kombinacija s TS)	3838987 511793	416,00
	TV4D/S 160 /K	samostoječa tuš vrata, četiridjelna	3838987 511779	384,00
	TV4D/S 160 /CH	(moguća kombinacija s TS)	3838987 511755	404,00
	TV4D/S 140 /K		3838987 511731	373,00
	TV4D/S 140 /CH		3838987 511717	389,00



Tuš kabine Tuš kabine	Program: SQ line Beli profili, H=190	Beli profili. Kaljeno prozorno (K) in kaljeno chinchilla steklo (CH), debelina stakla 5 mm. Bijeli profili. Kaljeno prozirno (K) i kaljeno chinchilla staklo (CH), debljina stakla 5 mm.		kolpa-san
Model	Naziv in dimenzija izdelka Naziv i dimenzije produkta	Opis Opis	EAN koda EAN koda	Cena EUR Cijena EUR
TS /K, CH 90, 80, 75, 70				
	TS 90/K	tuš stena (kombinacija s TKK, TKP, TV/2D, TV/4D) tuš stijena (kombinacija s TKK, TKP, TV/2D, TV/4D)	3838987 527671	168,00
	TS 90/CH		3838987 527657	176,00
	TS 80/K	3838987 527633	157,00	
	TS 80/CH	3838987 527619	165,00	
	TS 75/K	3838987 527596	150,00	
	TS 75/CH	3838987 527572	161,00	
	TS 70/K	3838987 527558	149,00	
TS 70/CH	3838987 527534	160,00		
Dodatki / Dodaci SQ line				
	K-30 BELI	kompensacijski profil za TKK, TKP, TV in TS SQ line / kompensacijski profil za TKK, TKP, TV in TS SQ line	3838987 527435	37,00



Tuš kabine Tuš kabine	Program: SQ line Beli profili, H=160	Beli profili. Kaljeno chinchilla steklo (CH), debelina stakla 5/6 mm. Bijeli profili. Kaljeno chinchilla staklo (CH), debljina stakla 5/6 mm.		kolpa-san
Model	Naziv in dimenzija izdelka Naziv i dimenzije produkta	Opis Opis	EAN koda EAN koda	Cena EUR Cijena EUR
TKP 90 /CH DIXIE	SNEMLJIVI VRATNI KRILI ODVOJIVA VRATNA KRILA			
	TKP 90 /CH DIXIE R550	tuš kabina - polkrožna, za tuš kad Dixie, h=160 tuš kabina - polukružna, za tuš kadu Dixie, h=160	3838987 511496	330,00

POS. DIM. TKK, TKP, TV2D/S, TV4D/S				
	TKK/K BELA	Posebne dimenzije Posebne dimenzije	3838987 512776	
	TKP/K BELA		3838987 512745	
	TV2D/S/K BELA		3838987 512806	
	TV4D/S/K BELA		3838987 512820	
	TS/K BELA		3838987 316732	

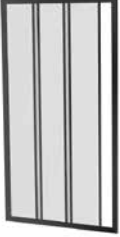

Tuš kabine Tuš kabine	Program: SQ line			
Model	Naziv in dimenzija izdelka Naziv i dimenzije produkta	Opis Opis	EAN koda EAN koda	Cena EUR Cijena EUR
Dodatki / Dodaci SQ line				
 <p>SDL</p> <p>STK-N</p> <p>STK</p>	<p>SDL</p> <p>STK-N</p> <p>STK</p>	<p>sedež za tuš kabino - višinsko nastavljiv sjedalo za tuš kabino - podesiv po visini</p> <p>sedež za tuš kabino z nogicami - preklopni sjedalo za tuš kabino sa nožicama - preklopni</p> <p>sedež za tuš kabino - preklopni sjedalo za tuš kabino - preklopni</p>	<p>3838987 593935</p> <p>3838987 573227</p> <p>3838987 950707</p>	<p>235,00</p> <p>174,00</p> <p>151,00</p>
	<p>KS</p>	<p>kopalniški stolček, h=40 cm, prenosni kupaonska stolica, h=40 cm, prenosni</p>	<p>3838987 950608</p>	<p>56,00</p>
	<p>Mast za ležaje in tečaje tuš kabin Mast za ležajeve i šarke tuš kabina</p>	<p>krt = 10 x 20 ml (Cena za kos / Cijena na komad 4,50 EUR)</p>	<p>3838987 994169</p>	<p>45,00</p>
	<p>Brisalec stekla Brisač stakla</p>	<p>Brisalec stekla z držalom krom Brisač stakla sa kromiranom ručkom</p>	<p>3838987 491095</p>	<p>24,00</p>
	<p>Specialno čistilo KOLPA SAN Specialno sredstvo za čiščenje</p> <p>Specialno čistilo ECO SAN Specialno sredstvo za čiščenje</p>	<p>krt = 20 x 0,5 l (Cena za kos / Cijena na komad 6,20 EUR)</p> <p>krt = 20 x 0,5 l (Cena za kos / Cijena na komad 5,40 EUR)</p>	<p>3838987 747291</p> <p>3838987 572220</p>	<p>124,00</p> <p>108,00</p>







Tuš kabine Tuš kabine		Program: LUNA Silver profili, H=185		Silver profili. Kaljeno prozorno staklo (K), deblina stakla 4 mm. Silver profili. Kaljeno prozorno staklo (K), deblina stakla 4 mm.		kolpa·san	
Model	Naziv in dimenzija izdelka Naziv i dimenzije produkta	Opis Opis	EAN koda EAN koda	Cena EUR Cijena EUR			
TV3D/S 100/K, 90/K, 80/K							
	TV3D/S 100/K	tuš vrata - tridelna	3838987 510673	232,00			
	TV3D/S 90/K	tuš vrata - trodijelna	3838987 560067	228,00			
	TV3D/S 80/K		3838987 560050	220,00			
TSv3D 90/K, 80/K							
	TSv3D 90/K, deblina stakla 6 mm	tuš stena za kombinacijo s TV3D/S	3838987 560111	140,00			
	TSv3D 80/K, deblina stakla 6 mm	tuš stijena za kombinaciju sa TV3D/S	3838987 560104	132,00			
Dodatki / Dodaci LUNA							
	K-30 TV3D/S	kompensacijski profil za TV3D/S kompensacijski profil za TV3D/S	3838987 534167	35,00			



Program: LUNA Silver profili, H=185		Silver profili. Kaljeno prozorno staklo (K), deblina stakla 4 mm. Silver profili. Kaljeno prozorno staklo (K), deblina stakla 4 mm.			
TVZ/S 90/K, 80/K					
	TVZ/S 90 /K	samostojna zložljiva tuš vrata	3838987 534129	264,00	
	TVZ/S 80 /K	samostojeća sklopiva tuš vrata	3838987 534082	252,00	
TSvZ 90/K, 80/K					
	TSvZ 90/K, deblina stakla 6 mm	tuš stena za kombinacijo s TVZ/S	3838987 560111	140,00	
	TSvZ 80/K, deblina stakla 6 mm	tuš stijena za kombinaciju sa TVZ/S	3838987 560104	132,00	
Dodatki / Dodaci LUNA					
	K-30 TVZ/S	kompensacijski profil za TVZ/S kompensacijski profil za TVZ/S	3838987 534167	35,00	





Tuš kabine Tuš kabine	Program: LUNA Silver profili, H=190	Silver profili. Kaljeno prozorno (K), debelina stekla 6 mm. Silver profili. Kaljeno prozorno (K), debljina stakla 6 mm.	kolpa-san	
Model	Naziv in dimenzija izdelka Naziv i dimenzije produkta	Opis Opis	EAN koda EAN koda	Cena EUR Cijena EUR
TVO/S 90/K, 80/K				
	TVO/S 90/K TVO/S 80/K	samostojna tuš vrata, obračalna samostoječa tuš vrata, okretljiva	3838987 534211 3838987 534198	268,00 256,00
Dodatki / Dodaci Luna				
	K-25 TVO/S	kompensacijski profil za TVO/S Luna kompensacijski profil za TVO/S Luna	3838987 534150	44,00

POS. DIM. TSvZ/TSv3D/K				
	TSvZ/TSv3D/K SILVER	Posebne dimenzije Posebne dimenzije	3838987 960690	

Dodatki / Dodaci LUNA				
	SDL STK-N STK	sedež za tuš kabino - višinsko nastavljiv sjedalo za tuš kabino - podesiv po visini sedež za tuš kabino z nogicama - preklopni sjedalo za tuš kabino sa nožicama - preklopni sedež za tuš kabino - preklopni sjedalo za tuš kabino - preklopni	3838987 593935 3838987 573227 3838987 950707	235,00 174,00 151,00
	KS	kopalniški stolček, h=40 cm, prenosni kupaonska stolica, h=40 cm, prenosni	3838987 950608	56,00
	Mast za ležaje in tečaje tuš kabin Mast za ležajeve i šarke tuš kabina	krt = 10 x 20 ml (Cena za kos / Cijena na komad 4,50 EUR)	3838987 994169	45,00
	Brisalec stekla Brisač stakla	Brisalec stekla z držalom krom Brisač stakla sa kromiranim ručkom	3838987 491095	24,00
	EL-SHOWER	Dvojna viseča odlagalna košarica za tuš kabino / Dvostruka viseća košarica za tuš kabinu	3838987 491101	98,00
	Specialno čistilo KOLPA SAN Specialno sredstvo za čišćenje Specialno čistilo ECO SAN Specialno sredstvo za čišćenje	krt = 20 x 0,5 l (Cena za kos / Cijena na komad 6,20 EUR) krt = 20 x 0,5 l (Cena za kos / Cijena na komad 5,40 EUR)	3838987 747291 3838987 572220	124,00 108,00

Tuš kabine Tuš kabine		Program: ECO QUAT Silver profili, H=185		Silver profili. Kaljeno prozorno staklo (K), debelina stakla 5 mm. Silver profili. Kaljeno prozorno staklo (K), debljina stakla 5 mm.		kolpa-san	
Model	Naziv in dimenzija izdelka Naziv i dimenzije produkta	Opis Opis	EAN koda EAN koda	Cena EUR Cijena EUR			
TKK 90/K, 80/K		SNEMLJIVI VRATNI KRILI ODVOJIVA VRATNA KRILA					
	TKK 90/K	tuš kabina - kotna	3838987 538561	185,00			
	TKK 80/K	tuš kabina - kutna	3838987 538554	176,00			
TKP 90/K, 80/K R550		SNEMLJIVI VRATNI KRILI ODVOJIVA VRATNA KRILA					
	TKP 90/K R550	tuš kabina - polkrožna	3838987 538585	195,00			
	TKP 80/K R550	tuš kabina - polukružna	3838987 538578	185,00			

Tuš kabine Tuš kabine		Program: ECO QUAT BLACK profili, H=185		BLACK profili. Kaljeno prozorno staklo (K), debelina stakla 5 mm. BLACK profili. Kaljeno prozorno staklo (K), debljina stakla 5 mm.		kolpa-san	
Model	Naziv in dimenzija izdelka Naziv i dimenzije produkta	Opis Opis	EAN koda EAN koda	Cena EUR Cijena EUR			
TKK 90/K, 80/K		SNEMLJIVI VRATNI KRILI ODVOJIVA VRATNA KRILA					
	TKK 90/K BLACK	tuš kabina - kotna	3838987 515289	204,00			
	TKK 80/K BLACK	tuš kabina - kutna	3838987 515234	194,00			
TKP 90/K, 80/K R550		SNEMLJIVI VRATNI KRILI ODVOJIVA VRATNA KRILA					
	TKP 90/K R550 BLACK	tuš kabina - polkrožna	3838987 515302	215,00			
	TKP 80/K R550 BLACK	tuš kabina - polukružna	3838987 515296	204,00			



Tuš kabine Tuš kabine	Program: ECO QUAT			
Model	Naziv in dimenzija izdelka Naziv i dimenzije produkta	Opis Opis	EAN koda EAN koda	Cena EUR Cijena EUR
Dodatki / Dodaci ECO QUAT				
 <p>SDL</p> <p>STK-N</p> <p>STK</p>	<p>SDL</p> <p>STK-N</p> <p>STK</p>	<p>sedež za tuš kabino - višinsko nastavljiv sjedalo za tuš kabino - podesiv po visini</p> <p>sedež za tuš kabino z nogicami - preklopni sjedalo za tuš kabino sa nožicama - preklopni</p> <p>sedež za tuš kabino - preklopni sjedalo za tuš kabino - preklopni</p>	<p>3838987 593935</p> <p>3838987 573227</p> <p>3838987 950707</p>	<p>235,00</p> <p>174,00</p> <p>151,00</p>
	<p>KS</p>	<p>kopalniški stolček, h=40 cm, prenosni kupaonska stolica, h=40 cm, prenosni</p>	<p>3838987 950608</p>	<p>56,00</p>
	<p>Mast za ležaje in tečaje tuš kabin Mast za ležajeve i šarke tuš kabina</p>	<p>krt = 10 x 20 ml (Cena za kos / Cijena na komad 4,50 EUR)</p>	<p>3838987 994169</p>	<p>45,00</p>
	<p>Brisalec stekla Brisač stakla</p>	<p>Brisalec stekla z držalom krom Brisač stakla sa kromiranom ručkom</p>	<p>3838987 491095</p>	<p>24,00</p>
	<p>Specialno čistilo KOLPA SAN Specialno sredstvo za čiščenje</p> <p>Specialno čistilo ECO SAN Specialno sredstvo za čiščenje</p>	<p>krt = 20 x 0,5 l (Cena za kos / Cijena na komad 6,20 EUR)</p> <p>krt = 20 x 0,5 l (Cena za kos / Cijena na komad 5,40 EUR)</p>	<p>3838987 747291</p> <p>3838987 572220</p>	<p>124,00</p> <p>108,00</p>



Zaslони za kopalne kadi

Paravani za kupaonske kade

Program: POLARIS, ANDROMEDA Silver brill in black profili, H=140

Silver brill in black profili. Kaljeno prozorno (/1) steklo, debelina stekla 8/6 mm, CLEAN COAT. / Silver brill in black profili. Kaljeno prozorno (/1) staklo, debljina stakla 8/6 mm, CLEAN COAT.

kolpa-san®

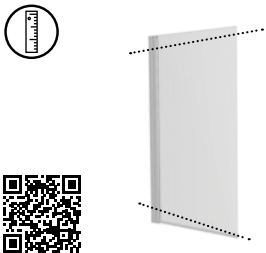
Model	Naziv in dimenzija izdelka Naziv i dimenzije produkta	Opis Opis	EAN koda EAN koda	Cena EUR Cijena EUR
BS 80 -UNI SBR, B/1				
	BS 80 -UNI SBR/1 Silver brill	POLARIS enodelni krilni zaslon za kopalne kadi / jednodijelni krilni zaslon za kupaonske kade	3838987 517733	211,00
	BS 80 -UNI B/1 Black	UNIVERZALNI CLEAN COAT premaz	3838987 517740	221,00
BS 80 -UNI SBR, B/1-1P				
	BS 80 -UNI SBR/1-1P Silver brill	ANDROMEDA enodelni krilni zaslon za kopalne kadi, zložljiv na notranjo ali zunanjo stran / jednodijelni krilni zaslon za kupaonske kade, zložljiv na unutarnju ili vanjsku stranu	3838987 517757	248,00
	BS 80 -UNI B/1-1P Black	UNIVERZALNI CLEAN COAT premaz	3838987 517764	261,00
BS 120 -UNI SBR, B/1-2P				
	BS 120 -UNI SBR/1-2P Silver brill	ANDROMEDA dvodelni krilni zaslon za kopalne kadi / dvodijelni krilni zaslon za kupaonske kade	3838987 517771	377,00
	BS 120 -UNI B/1-2P Black	UNIVERZALNI CLEAN COAT premaz	3838987 517788	396,00
POS. DIM. BS SBR, B/1, 1-1P, 1-2P				
	POLARIS BS/SBR/1 Silver brill	Posebne dimenzije Posebne dimenzije	3838987 400370	
	POLARIS BS/B/1 Black		3838987 400387	
	ANDROMEDA BS/1P/SBR/1 Silver brill	3838987 400394		
	ANDROMEDA BS/1P/B/1 Black	3838987 400400		
	ANDROMEDA BS/2P/SBR/1 Silver brill	3838987 400417		
	ANDROMEDA BS/2P/B/1 Black	3838987 400420		

Dodatki / Dodaci

	Brisalec stekla Brisač stakla	Brisalec stekla z držalom krom Brisač stakla sa kromiranom ručkom	3838987 491095	24,00
	Specijalno čistilo KOLPA SAN Specijalno sredstvo za čišćenje	krt = 20 x 0,5 l (Cena za kos / Cijena na komad 6,20 EUR)	3838987 747291	124,00
	Specijalno čistilo ECO SAN Specijalno sredstvo za čišćenje	krt = 20 x 0,5 l (Cena za kos / Cijena na komad 5,40 EUR)	3838987 572220	108,00



Zaslони za kopalne kadi
Paravani za kupaonske kade

Program: SOLE UNI
Silver profili, H=140

Silver profili. Kaljeno prozorno (K) steklo, debelina stekla 6 mm.
Silver profili, kaljeno prozirno (K) staklo, debjina stakla 6 mm.

kolpa-san

Model	Naziv in dimenzija izdelka Naziv i dimenzije produkta	Opis Opis	EAN koda EAN koda	Cena EUR Cijena EUR
TP 102/K UNI				
	TP 102/K -UNI	dvodelni krilni zaslon za kopalno kad Royal, Divante dvodijelni krilni zaslon za kupaonksu kadu Royal, Divante UNIVERZALNI	3838987 514800	307,00
TP 104/K UNI				
	TP 104/K -UNI	dvodelni krilni zaslon za kop. kad Calando dvodijelni krilni zaslon za kup. kadu Calando UNIVERZALNI	3838987 514817	309,00

OPORA STEKLA ZA TP

	OPORA STEKLA ZA TP	kromirana cevna opora (ø 15) za stabilizacijo stekla pri TP 102, 104; l=52 cm kromirana cijevna potpora (ø 15) za stabilizacijo stakla kod TP 102, 104; l=52 cm	3838987 536079	46,00
---	---------------------------	---	-----------------------	--------------

Program: QUAT UNI
Silver profili, H=140

Silver dvizni profili. Kaljeno prozorno steklo (K), debelina stekla 5 mm.
Silver podizni profili. Kaljeno prozirno staklo (K), debjina stakla 5 mm.

TP 80/K UNI				
	TP 80/K -UNI	enodelni krilni zaslon za kopalne kadi jednodijelni krilni zaslon za kupaonske kade UNIVERZALNI	3838987 516989	166,00

Zaslони za kopalne kadi
Paravani za kupaonske kade**Program: QUAT UNI**
Beli profili, H=140**BELI profili. Polistirensko steklo, debelina stakla 2 mm.**
BIJELI profili. Polistirensko staklo, debljina stakla 2 mm.



kolpa-san

Model	Naziv in dimenzija izdelka Naziv i dimenzije produkta	Opis Opis	EAN koda EAN koda	Cena EUR Cijena EUR
TP 108 UNI				
	TP 108 -UNI	dvodelni krilni zaslon za kop. kad CALANDO dvodijelni krilni zaslon za kup. kade CALANDO UNIVERZALNI	3838987 726753	162,00
TP 105 UNI				
	TP 105 -UNI	dvodelni krilni zaslon za kop. kad ROYAL, DIVANTE dvodijelni krilni zaslon za kup. kade ROYAL, DIVANTE UNIVERZALNI	3838987 314356	157,00

Dodatki / Dodaci

	Brisalec stekla Brisač stakla	Brisalec stekla z držalom krom Brisač stakla sa kromiranom ručkom	3838987 491095	24,00
	Specialno čistilo KOLPA SAN Specialno sredstvo za čišćenje	krt = 20 x 0,5 l (Cena za kos / Cijena na komad 6,20 EUR)	3838987 747291	124,00
	Specialno čistilo ECO SAN Specialno sredstvo za čišćenje	krt = 20 x 0,5 l (Cena za kos / Cijena na komad 5,40 EUR)	3838987 572220	108,00

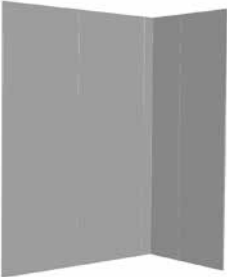
Tuš kabine
Tuš kabine

Model	Naziv in dimenzija izdelka Naziv i dimenzije produkta	Opis Opis	EAN koda EAN koda	Cena EUR Cijena EUR	
RE-WALL 160, 140, 120					
	Kerrock barva / Boja				
	RE-WALL 160x90	- white 109	Kerrock stena Kerrock stijena	3838987 551607	1.286,00
	RE-WALL 160x90	- andesite 9252		3838987 551614	1.395,00
	RE-WALL 160x80	- white 109	UNIVERZALNA	3838987 551584	1.235,00
	RE-WALL 160x80	- andesite 9252		3838987 551591	1.333,00
	RE-WALL 140x90	- white 109	Kerrock stena Kerrock stijena	3838987 551560	1.190,00
	RE-WALL 140x90	- andesite 9252		3838987 551577	1.286,00
	RE-WALL 140x80	- white 109	UNIVERZALNA	3838987 551546	1.136,00
	RE-WALL 140x80	- andesite 9252		3838987 551553	1.227,00
	RE-WALL 120x90	- white 109	Kerrock stena Kerrock stijena	3838987 551522	1.082,00
	RE-WALL 120x90	- andesite 9252		3838987 551539	1.168,00
	RE-WALL 120x80	- white 109	UNIVERZALNA	3838987 551508	1.027,00
	RE-WALL 120x80	- andesite 9252		3838987 551515	1.111,00
	RE-WALL 100, 90, 80				
	RE-WALL 100x100	- white 109	Kerrock stena Kerrock stijena	3838987 551485	1.024,00
	RE-WALL 100x100	- andesite 9252		3838987 551492	1.106,00
	RE-WALL 90x90	- white 109	Kerrock stena Kerrock stijena	3838987 551447	995,00
	RE-WALL 90x90	- andesite 9252		3838987 551454	1.074,00
	RE-WALL 80x80	- white 109	Kerrock stena Kerrock stijena	3838987 551461	958,00
	RE-WALL 80x80	- andesite 9252		3838987 551478	1.037,00
	UNIVERZALNA				
	UNIVERZALNA				

Dodatki / Dodaci

	KERIL - Specijalno čistilo za KERROCK KERIL - Specijalno sredstvo	krt = 12 x 0,5 l (Cena za kos / Cijena na komad 4,30 EUR)	3838987 747307	51,60
---	---	---	-----------------------	--------------

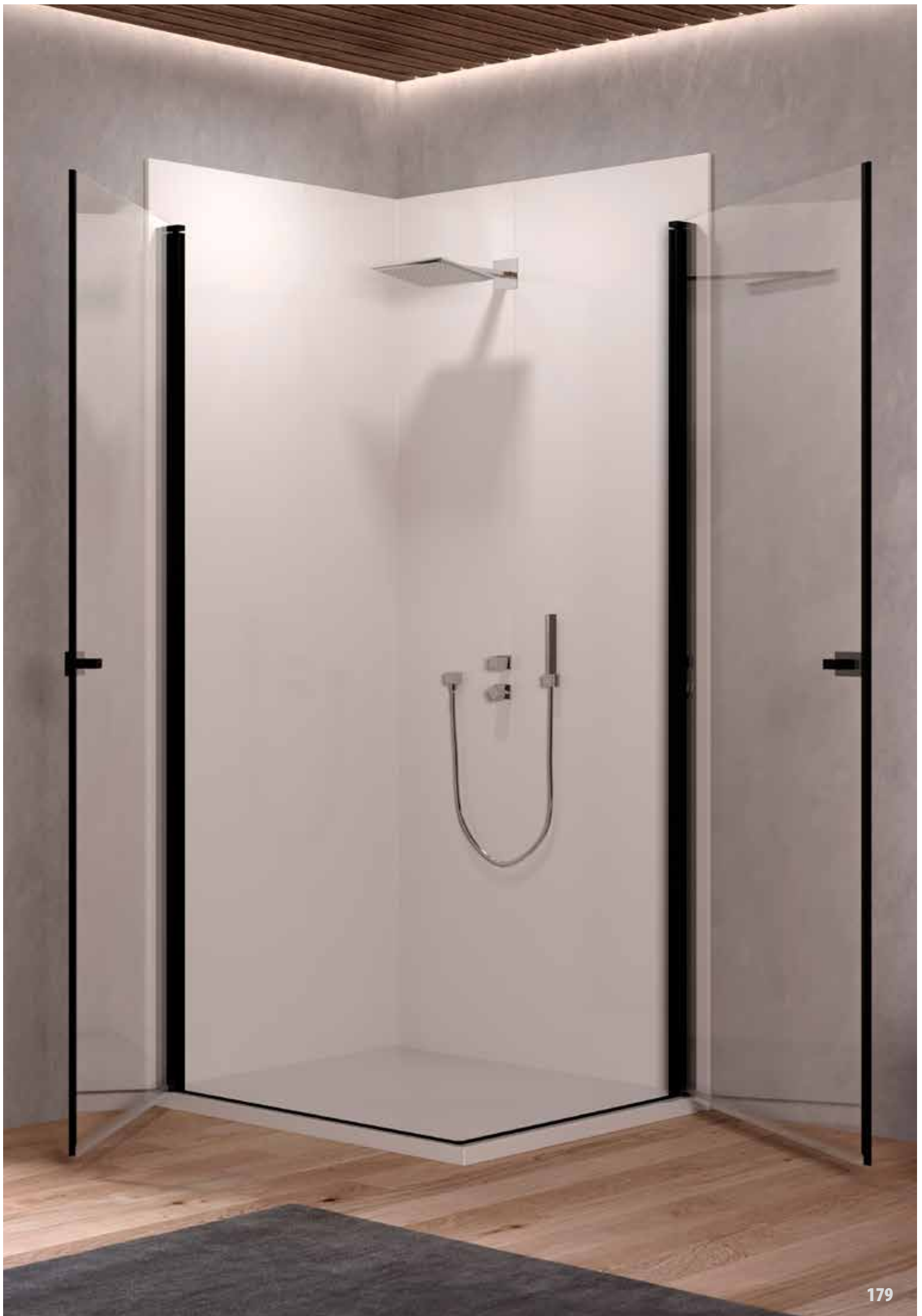

Tuš kabine
Tuš kabine







Kopalniško pohištvo Kupaonski namještaj

Alexis	182	Milo	199
Blanche	217	Naomi	223
Boul	203	Oxana	241
Donna	237	Pandora	211
Evelin	249	Ramona	205
Grace	195	Tara	231
Kiki	245	Vittoria	189
Lana	253	Samostojna ogledala, police	256
Malaya	207		



Demontirano, potrebna montaža / Rastavljeno, potrebna instalacija



Priložen sifon / Sifon uključen

LED - LED svetilka / LED svjetlo

T (Touch) - senzorsko stikalo

senzorski prekidač

SW (Switch) - stikalo / prekidač

S (Socket) - vtičnica / utičnica

C (Clock) - ura / sat

IR - senzorsko stikalo / senzorski prekidač

DIM - regulator intenzivnosti svetlobe
regulator intenzivnosti svjetla

(Š x V x G) - širina, višina, globina
širina, visina, dubina

2
leti garancije
godina jamstva

Slike su simbolične. Pravilna rasporeditev elementov je v TEHNIČNEM KATALOGU na www.kolpasan.si

Slike su simbolične. Tačan raspored elemenata je u TEHNIČKOM KATALOGU na www.kolpasan.hr

Pridržujemo si pravico do spremembe podatkov. Dimenzije so informativnega značaja.
Pridržavamo si pravo do promjena podataka. Dimenzije su informativnog karaktera.









Kopalniško pohištvo

Kupaonski namještaj

Program: ALEXIS

Fronte: MDF oplaćen s 3D folijo v dekorju – Dark Concrete (DC), Craft Wood (CW), Green (GN) Obod: Oplemenjena iverna ploča v dekorju (DC, CW, GN) Umivalnik: Kerrock / Fronte: MDF presvučen s 3D folijom u dekoru – Dark Concrete (DC), Craft Wood (CW), Green (GN) Obod: Oplemenjena iverna ploča u dekoru (DC, CW, GN) Umivaonik: Kerrock

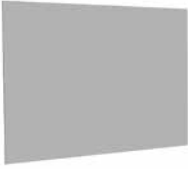
kolpa-san

Model	Naziv in dimenzija izdelka Naziv i dimenzije produkta	Opis Opis	EAN koda EAN koda	Cena EUR Cijena EUR
OG Ø 150 -LED, IR, DIM				
	OG Ø 150 (Ø 120+ Ø 80) -LED, IR, DIM (2 ogledala /ogledala, 3 lučke/svjetla) 1500 x 1200 x 30	ogledalo z LED svetilko, senzorsko stikalo (IR), regulator intenzivnosti svetlobe (DIM) / ogledalo sa LED svjetlom, senzorski prekidač (IR), regulator intenzivnosti svjetla (DIM) NEUTRAL WHITE	3838987 546450	510,00
OG Ø 120, 100, 80 -LED, IR, DIM				
	OG Ø 120 -LED, IR, DIM (2 lučki/svjetla) OG Ø 100 -LED, IR, DIM OG Ø 80 -LED, IR, DIM	ogledalo z LED svetilko, senzorsko stikalo (IR), regulator intenzivnosti svetlobe (DIM) / ogledalo sa LED svjetlom, senzorski prekidač (IR), regulator intenzivnosti svjetla (DIM) NEUTRAL WHITE	3838987 573708 3838987 573692 3838987 573685	380,00 285,00 253,00
OG 100, 80, 60 -LED, T				
	OG 100 -LED, T 1000 x 700 x 20 OG 80 -LED, T 800 x 700 x 20 OG 60 -LED, T 600 x 700 x 20	ogledalo z integrirano ambientalno LED svetilko, senzorsko stikalo (T) ogledalo s integriranim ambientalnim LED svjetlom, senzorski prekidač (T) NEUTRAL WHITE	3838987 507260 3838987 507253 3838987 507246	311,00 275,00 254,00
OG 120, OG 90 -LED, T, C				
	OG 120 -LED, T, C 1200 x 700 x 20 OG 90 -LED, T, C 900 x 700 x 20	ogledalo z integrirano LED svetilko in uro (C), senzorsko stikalo (T) ogledalo sa integriranim LED svjetlom i satom (C), senzorski prekidač (T) NEUTRAL WHITE	3838987 507819 3838987 507802	341,00 289,00
OG 150, 120, 100, 80, 60				
	OG 150 1500 x 700 x 20 OG 120 1200 x 700 x 20 OG 100 1000 x 700 x 20 OG 80 800 x 700 x 20 OG 60 600 x 700 x 20	ogledalo, pravokotno ogledalo, pravokotno	3838987 547419 3838987 546443 3838987 547402 3838987 546436 3838987 547389	123,00 108,00 94,00 83,00 72,00
POLICA OG 150, 120, 100, 80, 60				
	POLICA OG 150 WH 1505 x 22 x 120 POLICA OG 120 WH 1205 x 22 x 120 POLICA OG 100 WH 1005 x 22 x 120 POLICA OG 80 WH 805 x 22 x 120 POLICA OG 60 WH 605 x 22 x 120	polica za pravokotno ogledalo s konzolo polica za pravokotnu ogledalo s konzolom	3838987 547471 3838987 546474 3838987 547464 3838987 547440 3838987 547426	72,00 65,00 58,00 51,00 45,00
KOZMETIČNO OGLEDALO				
	KOZMETIČNO OGLEDALO Ø 25	povečevalno ogledalo, okroglo uvečavajuće ogledalo, okruglo	3838987 546535	110,00
182	www.kolpa.si	www.kolpa.hr		







Kopalniško pohištvo

Kupaonski namještaj

Program: ALEXIS

Fronte: MDF oplasčen s 3D folijo v dekorju – Dark Concrete (DC), Craft Wood (CW), Green (GN) Obod: Oplemenjena iverna plošča v dekorju (DC, CW, GN) Umivalnik: Kerrock / Fronte: MDF presvučen s 3D folijom u dekoru – Dark Concrete (DC), Craft Wood (CW), Green (GN) Obod: Oplemenjena iverna plošča u dekoru (DC, CW, GN) Umivaonik: Kerrock

kolpa-san®

Model	Naziv in dimenzija izdelka Naziv i dimenzije produkta	Opis Opis	EAN koda EAN koda	Cena EUR Cijena EUR
TO 150, 120, 100 BL -LED, SW, S				
	TO 150 BL -LED, SW, S 1500 x 700 x 130 TO 120 BL -LED, SW, S 1200 x 700 x 130 TO 100 BL -LED, SW, S 1000 x 700 x 130	toaletna omarica z LED svetilko, stikalo (SW), vtičnica (S) toaletni ormarič s LED svetlom, prekidač (SW), utičnica (S) NEUTRAL WHITE	3838987 546511 3838987 546504 3838987 528876	658,00 579,00 528,00
TO 80 BL -LED, SW, S				
	TO 80 BL -LED, SW, S 800 x 700 x 130	toaletna omarica z LED svetilko, stikalo (SW), vtičnica (S) toaletni ormarič s LED svetlom, prekidač (SW), utičnica (S) NEUTRAL WHITE	3838987 528869	446,00
TO 60 BL -LED, SW, S				
	TO 60 BL -LED, SW, S 600 x 700 x 130	toaletna omarica z LED svetilko, stikalo (SW), vtičnica (S) toaletni ormarič s LED svetlom, prekidač (SW), utičnica (S) NEUTRAL WHITE	3838987 528852	352,00
UMIV. SOFT 550 ON GLOSS				
	UMIV. SOFT 550 ON GLOSS 550 x 120 x 360	umivalnik iz Kerrocka umivaonik od Kerrocka Priložen zgornji del sifona/ Uključen gornji dio sifona	3838987 863250	230,00
UMIV. SOFT 380 ON GLOSS				
	UMIV. SOFT 380 ON GLOSS Ø 380 x 120	umivalnik iz Kerrocka umivaonik od Kerrocka Priložen zgornji del sifona/ Uključen gornji dio sifona	3838987 864103	216,00
UMIV. LUX 500 ON GLOSS				
	UMIV. LUX 500 ON GLOSS 500 x 120 x 360	umivalnik iz Kerrocka umivaonik od Kerrocka Priložen zgornji del sifona/ Uključen gornji dio sifona	3838987 864127	230,00
UMIV. LUX 380 ON GLOSS				
	UMIV. LUX 380 ON GLOSS 380 x 380 x 120	umivalnik iz Kerrocka umivaonik od Kerrocka Priložen zgornji del sifona/ Uključen gornji dio sifona	3838987 864110	216,00
www.kolpa.hr		www.kolpa.si		183



Model	Naziv in dimenzija izdelka Naziv i dimenzije produkta	Opis Opis	EAN koda EAN koda	Cena EUR Cijena EUR
OA 150				
	OA 150 GN OA 150 CW OA 150 DC 1500 x 342 x 500 Ni izvrtine za armaturo / Nema rupe za armaturo	podumivalniška omarica s Kerrock polico in predaloma element ispod umivaonika s ladicom i policom od Kerrocka Priložen spodnji del sifona/ Uključen donji dio sifona	3838987 546306 3838987 547259 3838987 547266	758,00 758,00 758,00
OA 120				
	OA 120 GN OA 120 CW OA 120 DC 1200 x 342 x 500 Ni izvrtine za armaturo / Nema rupe za armaturo	podumivalniška omarica s Kerrock polico in predaloma element ispod umivaonika s ladicom i policom od Kerrocka Priložen spodnji del sifona/ Uključen donji dio sifona	3838987 547228 3838987 547235 3838987 547242	541,00 541,00 541,00
OA 100				
	OA 100 GN OA 100 CW OA 100 DC 1000 x 342 x 500 Ni izvrtine za armaturo / Nema rupe za armaturo	podumivalniška omarica s Kerrock polico in predaloma element ispod umivaonika s ladicom i policom od Kerrocka Priložen spodnji del sifona/ Uključen donji dio sifona	3838987 547204 3838987 547211 3838987 546283	483,00 483,00 483,00
OA 80				
	OA 80 GN OA 80 CW OA 80 DC 800 x 342 x 500 Ni izvrtine za armaturo / Nema rupe za armaturo	podumivalniška omarica s Kerrock polico in predaloma element ispod umivaonika s ladicom i policom od Kerrocka Priložen spodnji del sifona/ Uključen donji dio sifona	3838987 546276 3838987 547181 3838987 547198	444,00 444,00 444,00
OA 60				
	OA 60 GN OA 60 CW OA 60 DC 600 x 342 x 500 Ni izvrtine za armaturo / Nema rupe za armaturo	podumivalniška omarica s Kerrock polico in predaloma element ispod umivaonika s ladicom i policom od Kerrocka Priložen spodnji del sifona/ Uključen donji dio sifona	3838987 547167 3838987 546269 3838987 547174	407,00 407,00 407,00

Model	Naziv in dimenzija izdelka Naziv i dimenzije produkta	Opis Opis	EAN koda EAN koda	Cena EUR Cijena EUR	
A 1462/15					
	A 1462/15 GN	omarica z ogledalnimi vratima ormarič sa ogledalom na vratima	3838987 547334	190,00	
	A 1462/15 CW		3838987 547341	190,00	
	A 1462/15 DC		3838987 546344	190,00	
	450 x 1460 x 150				
A 1461/750					
	A 1461/750 GN	omarica z vratima in predaloma ormarič sa vratima i ladicama	3838987 547297	430,00	
	A 1461/750 CW		3838987 547303	430,00	
	A 1461/750 DC		3838987 546320	430,00	
	750 x 1460 x 320				
A 1461					
	A 1461 GN	omarica z vratima in predaloma ormarič sa vratima i ladicama	3838987 546313	329,00	
	A 1461 CW		3838987 547273	329,00	
	A 1461 DC		3838987 547280	329,00	
	450 x 1460 x 320				
A 1011					
	A 1011 GN	omarica z vratima in predaloma ormarič sa vratima i ladicama	3838987 547310	290,00	
	A 1011 CW		3838987 546337	290,00	
	A 1011 DC		3838987 547327	290,00	
	450 x 1010 x 320				
LUČ 700, 500 BL -LED					
	LUČ 700 BL -LED	L=700	Svetilka (LED) za OG Svjetlo (LED) za OG NEUTRAL WHITE	3838987 547518	95,00
	LUČ 500 BL -LED	L=500		3838987 546542	88,00







Kopalniško pohištvo

Kupaonski namještaj

Program: ALEXIS

Fronte: MDF oplášen s 3D folijo v dekorju – Dark Concrete (DC), Craft Wood (CW), Green (GN) Obod:
Oplemenitena iverna plošča v dekorju (DC, CW, GN) Umivalnik: Kerrock / Fronte: MDF presvučen s 3D folijom u
dekoru – Dark Concrete (DC), Craft Wood (CW), Green (GN) Obod: Oplemenjena iverna ploča u dekoru (DC, CW, GN) Umivaonik:
Kerrock.

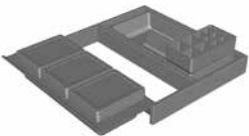
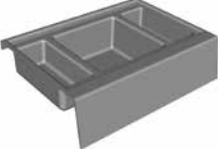
kolpa-san







Model	Naziv in dimenzija izdelka Naziv i dimenzije produkta	Opis Opis	EAN koda EAN koda	Cena EUR Cijena EUR
LUČ 300 -LED				
 	LUČ 300 -LED L = 300	svetilka (LED) brez vtičnice in stikala za OG svjetlo (LED) bez utičnice i prekidača za OG NEUTRAL WHITE	3838987 509974	53,00
ORGANIZATOR PREDALA				
	ORGANIZATOR PREDALA ZG.350	za zgornji predal pri OA 120, 100 za gornju ladicu kod OA 120, 100	3838987 529477	40,00
	ORGANIZATOR PREDALA SP.350	za spodnji predal za donju ladicu	3838987 529491	43,00
NOGICE POHIŠTVA				
 	NOGICE POHIŠTVA, h=40 cm	nogice za omarice, h=40 cm, (par) noge za ormariće, h=40 cm, (par)	3838987 505921	62,00



Kopalniško pohištvo
Kupaonski namještaj

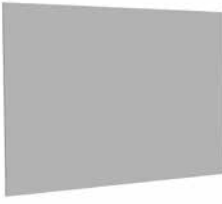



Model	Naziv in dimenzija izdelka Naziv i dimenzije produkta	Opis Opis	EAN koda EAN koda	Cena EUR Cijena EUR
OG Ø 120, 100, 80 -LED, IR, DIM				
	OG Ø 120 -LED, IR, DIM (2 lučki/svjetla)	ogledalo z LED svetilko, senzorsko stikalo (IR), regulator intenzivnosti svetlobe (DIM) ogledalo sa LED svjetlom, senzorski prekidač (IR), regulator intenzivnosti svjetla (DIM) NEUTRAL WHITE	3838987 573708	380,00
	OG Ø 100 -LED, IR, DIM		3838987 573692	285,00
	OG Ø 80 -LED, IR, DIM		3838987 573685	253,00
OG 120, OG 90 -LED, T, C				
	OG 120 -LED, T, C 1200 x 700 x 20	ogledalo z integrirano LED svetilko in uro (C), senzorsko stikalo (T) ogledalo sa integriranim LED svjetlom i satom (C), senzorski prekidač (T) NEUTRAL WHITE	3838987 507819	341,00
	OG 90 -LED, T, C 900 x 700 x 20		3838987 507802	289,00
OG 120, 100, 80, 60				
	OG 120 1200 x 700 x 20	ogledalo, pravokotno ogledalo, pravokutno	3838987 546443	108,00
	OG 100 1000 x 700 x 20		3838987 547402	94,00
	OG 80 800 x 700 x 20		3838987 546436	83,00
	OG 60 600 x 700 x 20		3838987 547389	72,00
POLICA OG 120, 100, 80, 60				
 	POLICA OG 120 WH 1205 x 22 x 120	polica za pravokotno ogledalo s konzolo polica za pravokutnu ogledalo s konzolom	3838987 546474	65,00
	POLICA OG 100 WH 1005 x 22 x 120		3838987 547464	58,00
	POLICA OG 80 WH 805 x 22 x 120		3838987 547440	51,00
	POLICA OG 60 WH 605 x 22 x 120		3838987 547426	45,00
KOZMETIČNO OGLEDALO				
	KOZMETIČNO OGLEDALO Ø 25	povečevalno ogledalo, okroglo uvečavajuće ogledalo, okruglo	3838987 546535	110,00



Kopalniško pohištvo
Kupaonski namještaj

Program: VITTORIA

Fronte: Lakiran MDF – White (WH), Dark Grey (DG), Beige (BE), Obod: Oplemenitena iverna ploča v dekorju – White (WH), Dark Grey (DG), Beige (BE), Umivalnik: Liti Marmor / Fronte: Lakiran MDF – White (WH), Dark Grey (DG), Beige (BE), Obod: Oplemenjena iverna ploča U dekoru – White (WH), Dark Grey (DG), Beige (BE), Umivaonik: Liveni Marmor

kolpa-san

Model	Naziv in dimenzija izdelka Naziv i dimenzije produkta	Opis Opis	EAN koda EAN koda	Cena EUR Cijena EUR
TO 120, 100 BL -LED, SW, S				
	TO 120 BL -LED, SW, S 1200 x 700 x 130	toaletna omarica z LED svetilko, stikalo (SW), vtičnica (S) toaletni ormarič s LED svetlom, prekidač (SW), utičnica (S) NEUTRAL WHITE	3838987 546504	579,00
	TO 100 BL -LED, SW, S 1000 x 700 x 130		3838987 528876	528,00
TO 80 BL -LED, SW, S				
	TO 80 BL -LED, SW, S	toaletna omarica z LED svetilko, stikalo (SW), vtičnica (S) toaletni ormarič s LED svetlom, prekidač (SW), utičnica (S) NEUTRAL WHITE	3838987 528869	446,00
	800 x 700 x 130			
TO 60 BL -LED, SW, S				
	TO 60 BL -LED, SW, S	toaletna omarica z LED svetilko, stikalo (SW), vtičnica (S) toaletni ormarič s LED svetlom, prekidač (SW), utičnica (S) NEUTRAL WHITE	3838987 528852	352,00
	600 x 700 x 130			
OUV 120				
	OUV 120 WH	omaraica z umivalnikom ormarič s umivaonikom Priložen spodnji in zgornji del sifona/ Uključen donji i gornji dio sifona	3838987 546214	919,00
	OUV 120 BE		3838987 547068	919,00
	OUV 120 DG		3838987 547075	919,00
	1200 x 472 x 500			
OUV 100				
	OUV 100 WH	omaraica z umivalnikom ormarič s umivaonikom Priložen spodnji in zgornji del sifona/ Uključen donji i gornji dio sifona	3838987 547044	836,00
	OUV 100 BE		3838987 546207	836,00
	OUV 100 DG		3838987 547051	836,00
	1000 x 472 x 500			







Kopalniško pohištvo

Kupaonski namještaj

Program: VITTORIA

Fronte: Lakiran MDF – White (WH), Dark Grey (DG), Beige (BE), Obod: Oplemenitena iverna plošča v dekorju - White (WH), Dark Grey (DG), Beige (BE), Umivalnik: Liti Marmor / Fronte: Lakiran MDF – White (WH), Dark Grey (DG), Beige (BE), Obod: Oplemenjena iverna ploča U dekoru - White (WH), Dark Grey (DG), Beige (BE), Umivaonik: Liveni Mramor

kolpa-san

Model	Naziv in dimenzija izdelka Naziv i dimenzije produkta	Opis Opis	EAN koda EAN koda	Cena EUR Cijena EUR
OUV 80				
	OUV 80 WH	omariča z umivalnikom ormarič s umivaonikom Priložen spodnji in zgornji del sifona/ Uključen donji i gornji dio sifona	3838987 547020	782,00
	OUV 80 BE		3838987 547037	782,00
	OUV 80 DG		3838987 546191	782,00
	800 x 472 x 500			
OUV 60				
	OUV 60 WH	omariča z umivalnikom ormarič s umivaonikom Priložen spodnji in zgornji del sifona/ Uključen donji i gornji dio sifona	3838987 546184	711,00
	OUV 60 BE		3838987 547006	711,00
	OUV 60 DG		3838987 547013	711,00
	600 x 472 x 500			
V 1481/790				
	V 1481/790 WH	omariča z vrati in predaloma ormarič sa vratima i ladicama	3838987 547082	529,00
	V 1481/790 BE		3838987 547099	529,00
	V 1481/790 DG		3838987 546221	529,00
	790 x 1475 x 320			
V 1481				
	V 1481 WH	omariča z vrati in predaloma ormarič sa vratima i ladicama	3838987 546238	384,00
	V 1481 BE		3838987 547105	384,00
	V 1481 DG		3838987 547112	384,00
	450 x 1475 x 320			
V 702/20				
	V 702/20 WH	omariča z vrati ormarič sa vratima	3838987 546252	133,00
	V 702/20 BE		3838987 547143	133,00
	V 702/20 DG		3838987 547150	133,00
	450 x 700 x 200			







Kopalniško pohištvo

Kupaonski namještaj

Program: VITTORIA







Fronte: Lakiran MDF – White (WH), Dark Grey (DG), Beige (BE), Obod: Oplemenitena iverna plošča v dekorju – White (WH), Dark Grey (DG), Beige (BE), Umivalnik: Liti Marmor / Fronte: Lakiran MDF – White (WH), Dark Grey (DG), Beige (BE), Obod: Oplemenjena iverna ploča U dekoru – White (WH), Dark Grey (DG), Beige (BE), Umivaonik: Liveni Mramor







kolpa-san

Model	Naziv in dimenzija izdelka Naziv i dimenzije produkta	Opis Opis	EAN koda EAN koda	Cena EUR Cijena EUR
OV 45				
	OV 45 WH	omara z vrati ormarič sa vratima	3838987 546245	207,00
	OV 45 BE		3838987 547129	207,00
	OV 45 DG		3838987 547136	207,00
	450 x 325 x 450			
LUČ 700, 500 BL -LED				
	LUČ 700 BL -LED L=700	Svetilka (LED) za OG Svjetlo (LED) za OG NEUTRAL WHITE	3838987 547518	95,00
	LUČ 500 BL -LED L=500		3838987 546542	88,00
LUČ 300 -LED				
	LUČ 300 -LED L = 300	svetilka (LED) brez vtičnice in stikala za OG svjetlo (LED) bez utičnice i prekidača za OG NEUTRAL WHITE	3838987 509974	53,00
NOGICE POHIŠTVA				
	NOGICE POHIŠTVA, h=40 cm	nogice za omarice, h=40 cm, (par) noge za ormariče, h=40 cm, (par)	3838987 505921	62,00



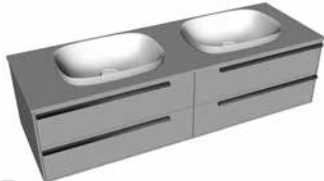

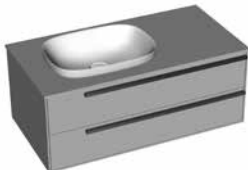
Model	Naziv in dimenzija izdelka Naziv i dimenzije produkta	Opis Opis	EAN koda EAN koda	Cena EUR Cijena EUR
OG Ø 150 -LED, IR, DIM				
	OG Ø 150 (Ø 120 + Ø 80) -LED, IR, DIM (2 ogledala /ogledala, 3 lučke/svjetla) 1500 x 1200 x 30	ogledalo z LED svetilko, senzorsko stikalo (IR), regulator intenzivnosti svetlobe (DIM) / ogledalo sa LED svjetlom, senzorski prekidač (IR), regulator intenzivnosti svjetla (DIM) NEUTRAL WHITE	3838987 546450	510,00
OG Ø 100, 80 -LED, IR, DIM				
	OG Ø 100 -LED, IR, DIM OG Ø 80 -LED, IR, DIM	ogledalo z LED svetilko, senzorsko stikalo (IR), regulator intenzivnosti svetlobe (DIM) / ogledalo sa LED svjetlom, senzorski prekidač (IR), regulator intenzivnosti svjetla (DIM) NEUTRAL WHITE	3838987 573692 3838987 573685	285,00 253,00
OG 100, 80 -LED, T				
	OG 100 -LED, T 1000 x 700 x 20 OG 80 -LED, T 800 x 700 x 20	ogledalo z integrirano ambientalno LED svetilko, senzorsko stikalo (T) / ogledalo s integriranim ambientalnim LED svjetlom, senzorski prekidač (T) NEUTRAL WHITE	3838987 507260 3838987 507253	311,00 275,00
OG 120, OG 90 -LED, T, C				
	OG 120 -LED, T, C 1200 x 700 x 20 OG 90 -LED, T, C 900 x 700 x 20	ogledalo z integrirano LED svetilko in uro (C), senzorsko stikalo (T) / ogledalo sa integriranim LED svjetlom i satom (C), senzorski prekidač (T) NEUTRAL WHITE	3838987 507819 3838987 507802	341,00 289,00
OG 150, 120, 100, 70				
	OG 150 1500 x 700 x 20 OG 100 1000 x 700 x 20 OG 70 700 x 700 x 20	ogledalo, pravokotno ogledalo, pravokotno	3838987 547419 3838987 547402 3838987 546412	123,00 94,00 76,00
POLICA OG 150, 100, 70				
	POLICA OG 150 WH 1505 x 22 x 120 POLICA OG 100 WH 1005 x 22 x 120 POLICA OG 70 WH 705 x 22 x 120	polica za pravokotno ogledalo s konzolo polica za pravokutnu ogledalo s konzolom	3838987 547471 3838987 547464 3838987 547433	72,00 58,00 47,00
KOZMETIČNO OGLEDALO				
	KOZMETIČNO OGLEDALO Ø 25	povečevalno ogledalo, okroglo uvečavajuće ogledalo, okruglo	3838987 546535	110,00
www.kolpa.hr		www.kolpa.si		195

Model	Naziv in dimenzija izdelka Naziv i dimenzije produkta	Opis Opis	EAN koda EAN koda	Cena EUR Cijena EUR
TO 150 BL -LED, SW, S				
	TO 150 BL -LED, SW, S 1500 x 700 x 130	toaletna omarica z LED svetilko, stikalo (SW), vtičnica (S) toaletni ormarič s LED svetlom, prekidač (SW), utičnica (S) NEUTRAL WHITE	3838987 546511	658,00
TO 100 BL -LED, SW, S				
	TO 100 BL -LED, SW, S 1000 x 700 x 130	toaletna omarica z LED svetilko, stikalo (SW), vtičnica (S) toaletni ormarič s LED svetlom, prekidač (SW), utičnica (S) NEUTRAL WHITE	3838987 528876	528,00
TO 70 BL -LED, SW, S				
	TO 70 BL -LED, SW, S 700 x 700 x 130	toaletna omarica z LED svetilko, stikalo (SW), vtičnica (S) toaletni ormarič s LED svetlom, prekidač (SW), utičnica (S) NEUTRAL WHITE	3838987 546498	402,00
OUG 150				
 	OUG 150 LC OUG 150 HO 1500 x 444 x 520	omariča z umivalnikom ormarič s umivaonikom ima izvrtino za armaturo/ ima otvor za armaturo Priložen spodnji in zgornji del sifona/ Uključen donji i gornji dio sifona	3838987 546375 3838987 547372	1.335,00 1.335,00
OUG 100				
 	OUG 100 LC OUG 100 HO 1000 x 444 x 520	omariča z umivalnikom ormarič s umivaonikom ima izvrtino za armaturo/ ima otvor za armaturo Priložen spodnji in zgornji del sifona/ Uključen donji i gornji dio sifona	3838987 546368 3838987 547365	854,00 854,00







Kopalniško pohištvo

Kupaonski namještaj



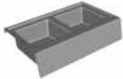

Program: GRACE

Fronte: Oplemenitena iverna plošča v dekorju – Halifax Oak (HO), Light Concrete (LC) Obod: Lakiran MDF – Black (BL) Umivalnik: Kerrock umivalnik delno vgrajen v Kerrock pult
Fronte: Oplemenjena iverna plošča u dekorju – Halifax Oak (HO), Light Concrete (LC) Obod: Lakiran MDF – Black (BL)
Umivaonik: Kerrock umivaonik dijelno ugrađen u Kerrock pult





kolpa·san®

Model	Naziv in dimenzija izdelka Naziv i dimenzije produkta	Opis Opis	EAN koda EAN koda	Cena EUR Cijena EUR	
OUG 70					
	OUG 70 LC	omarica z umivalnikom ormarič s umivaonikom ima izvrtino za armaturo/ ima otvor za armaturo Priložen spodnji in zgornji del sifona/ Uključen donji i gornji dio sifona	3838987 547358	812,00	
	OUG 70 HO		3838987 546351	812,00	
700 x 444 x 520					
G 1451					
	G 1451 LC	omarica z vrati in predaloma ormarič sa vratima i ladicama	3838987 546382	523,00	
	G 1451 HO		3838987 546399	523,00	
500 x 1450 x 320					
LUČ 700, 500 BL -LED					
	LUČ 700 BL -LED	L=700	Svetilka (LED) za OG Svjetlo (LED) za OG NEUTRAL WHITE	3838987 547518	95,00
	LUČ 500 BL -LED	L=500		3838987 546542	88,00
LUČ 300 -LED					
	LUČ 300 -LED	L = 300	svetilka (LED) brez vtičnice in stikala za OG svjetlo (LED) bez utičnice i prekidača za OG NEUTRAL WHITE	3838987 509974	53,00
ORGANIZATOR PREDALA					
	ORGANIZATOR PREDALA ZG.400		za zgornji predal pri OUG 100 za gornju ladicu kod OUG 100	3838987 529460	45,00
	ORGANIZATOR PREDALA SP.400		za spodnji predal za donju ladicu	3838987 529484	45,00
NOGICE POHIŠTVA					
	NOGICE POHIŠTVA, h=40 cm		nogice za omarice, h=40 cm, (par) noge za ormariče, h=40 cm, (par)	3838987 505921	62,00





Model	Naziv in dimenzija izdelka Naziv i dimenzije produkta	Opis Opis	EAN koda EAN koda	Cena EUR Cijena EUR
Milo mirror 120x60				
	Milo mirror 120x60 -WHITE	ogledalo ogledalo	3838987 591603	282,00
Milo shelf 120x20				
	Milo shelf 120x20 -WHITE	polica polica	3838987 591610	141,00
Milo basin double + shelf 120x60 (180x60)				
	Milo basin double 120x60+SH. -WHITE	samostoječi dvojni umivalnik z belo polico, barva zunanjega dela; WHITE, BLACK, SAND, V.RED, L.GREEN, P.BLUE samostoječi dvostruki umivaonik sa bijelom policom, boja vanjskog dijela; WHITE, BLACK, SAND, V.RED, L.GREEN, P.BLUE	3838987 591542	945,00
	Milo basin double 120x60+SH. -BLACK&WHITE		3838987 592341	1.267,00
	Milo basin double 120x60+SH. -SAND&WHITE		3838987 592358	1.267,00
	Milo basin double 120x60+SH. -V.RED&WHITE		3838987 592365	1.267,00
	Milo basin double 120x60+SH. -L.GREEN&WHITE		3838987 592372	1.267,00
	Milo basin double 120x60+SH. -P.BLUE&WHITE		3838987 592389	1.267,00
Milo basin double 120x60				
	Milo basin double 120x60 -WHITE	samostoječi dvojni umivalnik barva zunanjega dela; WHITE, BLACK, SAND, V.RED, L.GREEN, P.BLUE samostoječi dvostruki umivaonik boja vanjskog dijela; WHITE, BLACK, SAND, V.RED, L.GREEN, P.BLUE	3838987 561620	904,00
	Milo basin double 120x60 -BLACK&WHITE		3838987 561637	1.224,00
	Milo basin double 120x60 -SAND&WHITE		3838987 561644	1.224,00
	Milo basin double 120x60 -V.RED&WHITE		3838987 561651	1.224,00
	Milo basin double 120x60 -L.GREEN&WHITE		3838987 561668	1.224,00
	Milo basin double 120x60 -P.BLUE&WHITE		3838987 561675	1.224,00



Model	Naziv in dimenzija izdelka Naziv i dimenzije produkta	Opis Opis	EAN koda EAN koda	Cena EUR Cijena EUR
Milo mirror 70x51				
	Milo mirror 70x51 -WHITE	ogledalo ogledalo	3838987 591627	143,00
Milo shelf 70x20				
	Milo shelf 70x20 -WHITE	polica polica	3838987 591634	86,00
Milo basin single + shelf 70x51 (101x51)				
	Milo basin single 70x51+SH. -WHITE	samostojeći enojni umivalnik z belo	3838987 591559	554,00
	Milo basin single 70x51+SH. -BLACK&WHITE	polico, s sifonom, barva zunanjega dela;	3838987 592396	752,00
	Milo basin single 70x51+SH. -SAND&WHITE	WHITE, BLACK, SAND, V.RED, L.GREEN,	3838987 592402	752,00
	Milo basin single 70x51+SH. -V.RED&WHITE	P.BLUE	3838987 592419	752,00
	Milo basin single 70x51+SH. -L.GREEN&WHITE	samostojeći jednostruki umivaonik sa bijelom	3838987 592426	752,00
	Milo basin single 70x51+SH. -P.BLUE&WHITE	policom, sa sifonom, boja vanjskog dijela;	3838987 592433	752,00
Milo basin single 70x51				
	Milo basin single 70x51 -WHITE	samostojeći enojni umivalnik	3838987 561682	530,00
	Milo basin single 70x51 -BLACK&WHITE	s sifonom, barva zunanjega dela; WHITE,	3838987 561699	728,00
	Milo basin single 70x51 -SAND&WHITE	BLACK, SAND, V.RED, L.GREEN, P.BLUE	3838987 561705	728,00
	Milo basin single 70x51 -V.RED&WHITE	samostojeći jednostruki umivaonik	3838987 561712	728,00
	Milo basin single 70x51 -L.GREEN&WHITE	sa sifonom, boja vanjskog dijela;	3838987 561729	728,00
	Milo basin single 70x51 -P.BLUE&WHITE	WHITE, BLACK, SAND, V.RED, L.GREEN, P.BLUE	3838987 592921	728,00











Model	Naziv in dimenzija izdelka Naziv i dimenzije produkta	Opis Opis	EAN koda EAN koda	Cena EUR Cijena EUR
Boul mirror 120x60				
	Boul mirror 120x60 -WHITE	Ogledalo Ogledalo	3838987 591641	282,00
Boul mirror Ø 60				
	Boul mirror Ø 60 -WHITE	Ogledalo Ogledalo	3838987 591665	185,00
Boul basin Ø 40				
	Boul basin Ø 40 -WHITE	Enojni umivalnik z izvlečnim odtočnim sistemom, s sifonom, barva zunanjega dela: WHITE, BLACK, SAND Jednostruki umivaonik s sustavom odvodnje na izvlačenje, sa sifonom, boja vanjskog dijela: WHITE, BLACK,SAND	3838987 591597	413,00
	Boul basin Ø 40 -BLACK&WHITE		3838987 592280	548,00
	Boul basin Ø 40 -SAND&WHITE		3838987 592297	548,00



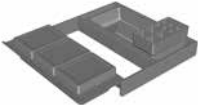











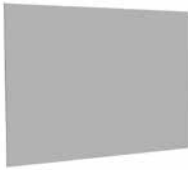



Kopalniško pohištvo Kupaonski namještaj	Program: RAMONA		Fronta in obod: MDF, lakiran, antracit MAT, Umivalnik: kerrock, Ročaj: kovinski, antracit, krtačen, Predali: tankostenski, kovinski mehko zapiranje <small>Fronta i obod: MDF, lakirano mat ANT, Umivaonik: kerrock, Ručka: metal, četkani efekt, Ladice: metalni, s mekim zatvaranjem</small>		
Model	Naziv in dimenzija izdelka <small>Naziv i dimenzije produkta</small>	Opis <small>Opis</small>	EAN koda <small>EAN koda</small>	Cena EUR <small>Cijena EUR</small>	
OGR 60-LED, T, DIM, CCT NEW					
	OGR 60-LED, T, DIM, CCT NEW <small>630 x 750 x 61</small>	ogledalo, LED ogledalna/ambientalna svetilka, senzorsko stikalo T (Touch), DIM regulator intenzivnosti svetlobe, CCT - sprememba barve svetlobe (toplo-hladno bela) / ogledalo s LED ogledalno/ambientalnim svetlom, senzorski prekidač T (Touch), DIM regulator intenzivnosti svetla, CCT regulator boje svetlosti (toplo-hladno bijela)	3838987 547747	696,00	
POLICA OGR 60/K					
	POLICA OGR 60/K <small>550 x 24 x 150</small>	Kerrock polica <small>Polica od Kerrocka</small>	3838987 516590	97,00	
OUR 160 ANT					
 <small>5 x 2</small>	OUR 160 ANT <small>1595 x 361,5 x 500</small>	omara z dvojnimi umivalnikom <small>ormarič sa duplim umivaonikom</small>	3838987 538820	1.584,00	
OUR 80 ANT					
 <small>5</small>	OUR 80 ANT <small>822 x 361,5 x 500</small>	omara z umivalnikom <small>ormarič s umivaonikom</small>	3838987 514336	934,00	
R 1432/640 ANT					
	R 1432/640 ANT <small>638 x 1434 x 300</small>	omara z vrati in policami <small>ormarič sa vratima i ladicama</small>	3838987 514367	708,00	
ORGANIZATOR PREDALA					
	ORGANIZATOR PREDALA ZG.350	za zgornji predal <small>za gornju ladicu</small>	3838987 529477	40,00	
Ramona basin 61x38x90					
	Ramona basin 61x38x90 - WHITE	samostoječi umivalnik <small>samostoječi umivaonik</small>	3838987 922612	930,00	
www.kolpa.si		www.kolpa.hr		205	



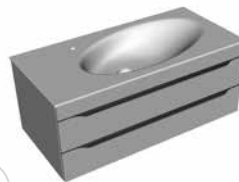

Model	Naziv in dimenzija izdelka Naziv i dimenzije produkta	Opis Opis	EAN koda EAN koda	Cena EUR Cijena EUR
OG Ø 150 -LED, IR, DIM				
	OG Ø 150 (Ø 120 + Ø 80) -LED, IR, DIM (2 ogledala /ogledala, 3 lučke/svjetla) 1500 x 1200 x 30	ogledalo z LED svetilko, senzorsko stikalo (IR), regulator intenzivnosti svetlobe (DIM) / ogledalo sa LED svjetlom, senzorski prekidač (IR), regulator intenzivnosti svjetla (DIM) NEUTRAL WHITE	3838987 546450	510,00
OG Ø 120, 100, 80 -LED, IR, DIM				
	OG Ø 120 -LED, IR, DIM (2 lučki/svjetla) OG Ø 100 -LED, IR, DIM OG Ø 80 -LED, IR, DIM	ogledalo z LED svetilko, senzorsko stikalo (IR), regulator intenzivnosti svetlobe (DIM) / ogledalo sa LED svjetlom, senzorski prekidač (IR), regulator intenzivnosti svjetla (DIM) NEUTRAL WHITE	3838987 573708 3838987 573692 3838987 573685	380,00 285,00 253,00
OG 100, 80 -LED, T				
	OG 100 -LED, T 1000 x 700 x 20 OG 80 -LED, T 800 x 700 x 20	ogledalo z integrirano ambientalno LED svetilko, senzorsko stikalo (T) / ogledalo s integriranim ambientalnim LED svjetlom, senzorski prekidač (T) NEUTRAL WHITE	3838987 507260 3838987 507253	311,00 275,00
OG 120, OG 90 -LED, T, C				
	OG 120 -LED, T, C 1200 x 700 x 20 OG 90 -LED, T, C 900 x 700 x 20	ogledalo z integrirano LED svetilko in uro (C), senzorsko stikalo (T) / ogledalo sa integriranim LED svjetlom i satom (C), senzorski prekidač (T) NEUTRAL WHITE	3838987 507819 3838987 507802	341,00 289,00
OG 150, 120, 100, 90, 80				
	OG 150 1500 x 700 x 20 OG 120 1200 x 700 x 20 OG 100 1000 x 700 x 20 OG 90 900 x 700 x 20 OG 80 800 x 700 x 20	ogledalo, pravokotno ogledalo, pravokutno	3838987 547419 3838987 546443 3838987 547402 3838987 547396 3838987 546436	123,00 108,00 94,00 88,00 83,00
POLICA OG 150, 120, 100, 90, 80				
 	POLICA OG 150 WH 1505 x 22 x 120 POLICA OG 120 WH 1205 x 22 x 120 POLICA OG 100 WH 1005 x 22 x 120 POLICA OG 90 WH 905 x 22 x 120 POLICA OG 80 WH 805 x 22 x 120	polica za pravokotno ogledalo s konzolo polica za pravokutnu ogledalo s konzolom	3838987 547471 3838987 546474 3838987 547464 3838987 547457 3838987 547440	72,00 65,00 58,00 55,00 51,00

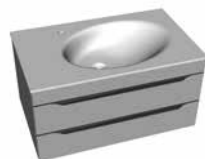

Model	Naziv in dimenzija izdelka Naziv i dimenzije produkta	Opis Opis	EAN koda EAN koda	Cena EUR Cijena EUR
KOZMETIČNO OGLEDALO				
	KOZMETIČNO OGLEDALO Ø 25	povečevalno ogledalo, okroglo uvečavajuće ogledalo, okruglo	3838987 546535	110,00
OUM 140				
	OUM 140 DARK GRAY OUM 140 NATUR OAK 1410 x 412 x 500	omariča z dvojnimi umivalnikom ormarič sa duplim umivaonikom Priložen spodnji in zgornji del sifona/ Uključen donji i gornji dio sifona	3838987 573661 3838987 573678	1.198,00 1.198,00
 x2				
OUM 100				
	OUM 100 DARK GRAY OUM 100 NATUR OAK 1100 x 412 x 500	omariča z umivalnikom ormarič s umivaonikom Priložen spodnji in zgornji del sifona/ Uključen donji i gornji dio sifona	3838987 573630 3838987 573647	769,00 769,00
				
OUM 80				
	OUM 80 DARK GRAY OUM 80 NATUR OAK 810 x 412 x 500	omariča z umivalnikom ormarič s umivaonikom Priložen spodnji in zgornji del sifona/ Uključen donji i gornji dio sifona	3838987 573609 3838987 573616	680,00 680,00
				
M 1301/1000				
	M 1301/1000 DARK GRAY M 1301/1000 NATUR OAK 1000 x 1300 x 318	omariča z vrati in predaloma ormarič sa vratima i ladicama	3838987 573784 3838987 573791	669,00 669,00







Kopalniško pohištvo

Kupaonski namještaj

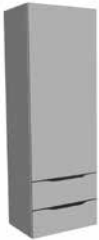
Program: MALAYA



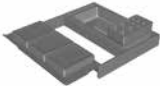

Umivalnik: Kerrock, fronte in obod: MDF oplášen s 3D folijo, barva: temno siva (DARK GRAY), hrast (NATUR OAK) / umivaonik: Kerrock, fronte i obod: MDF presvučen 3D folijom, boja: tamno siva (DARK GRAY), hrast (NATUR OAK)

kolpa-san

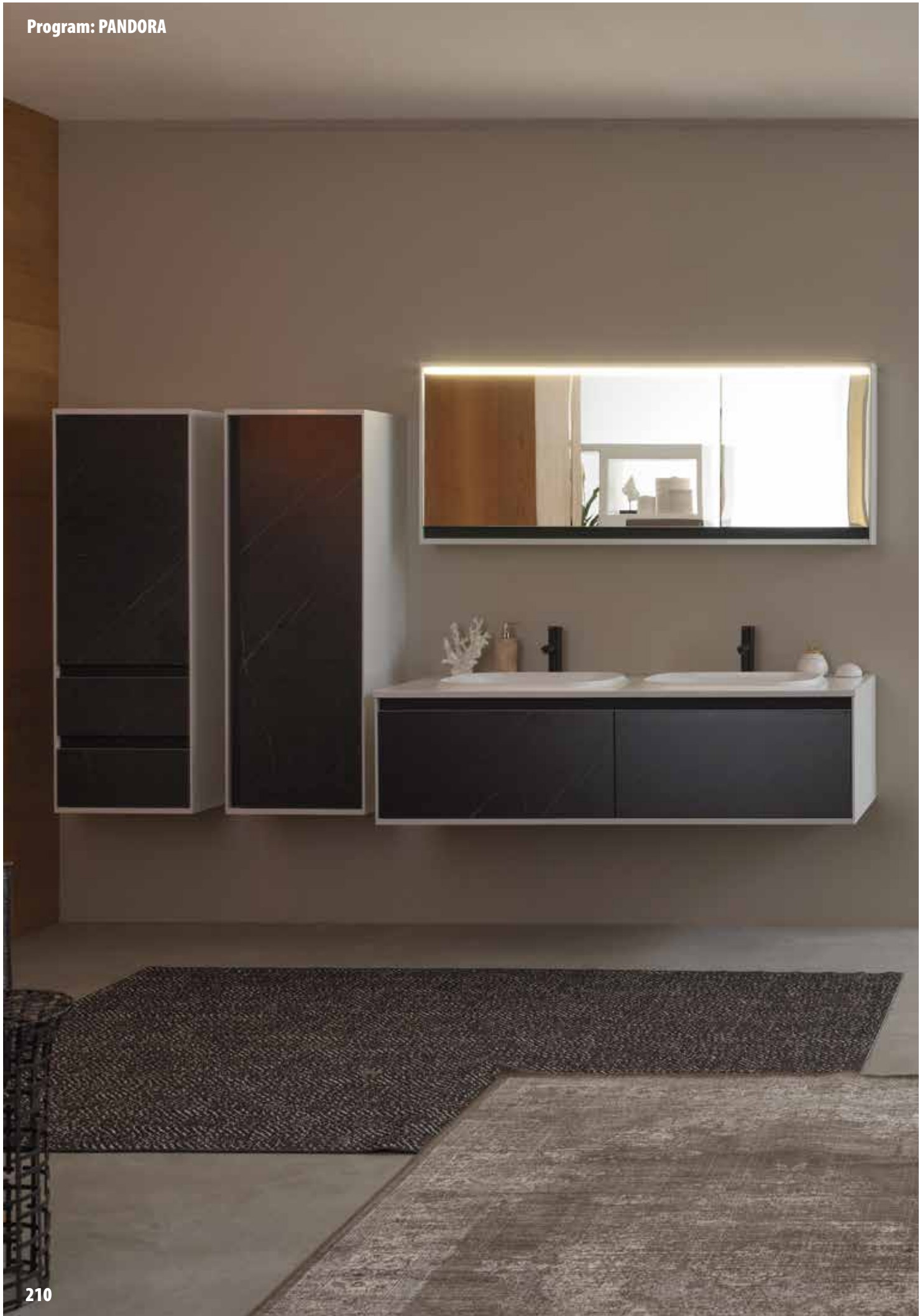

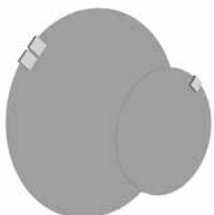

Model	Naziv in dimenzija izdelka Naziv i dimenzije produkta	Opis Opis	EAN koda EAN koda	Cena EUR Cijena EUR
M 1301				
	M 1301 DARK GRAY	omariča z vrati in predaloma ormarič sa vratima i ladicama	3838987 573722	436,00
	M 1301 NATUR OAK		3838987 573739	436,00
	450 x 1300 x 318			
M 1302/15				
	M 1302/15 DARK GRAY	omariča z ogledalnimi vrati ormarič sa ogledalom na vratima	3838987 573753	201,00
	M 1302/15 NATUR OAK		3838987 573760	201,00
	450 x 1300 x 150			
LUČ 700, 500 BL -LED				
	LUČ 700 BL -LED L=700	Svetilka (LED) za OG Svjetlo (LED) za OG NEUTRAL WHITE	3838987 547518	95,00
	LUČ 500 BL -LED L=500		3838987 546542	88,00
LUČ 300 -LED				
	LUČ 300 -LED L = 300	svetilka (LED) brez vtičnice in stikala za OG / svjetlo (LED) bez utičnice i prekidača za OG NEUTRAL WHITE	3838987 509974	53,00
ORGANIZATOR PREDALA				
	ORGANIZATOR PREDALA ZG.350	za zgornji predal za gornju ladicu	3838987 529477	40,00
NOGICE POHIŠTVA				
	NOGICE POHIŠTVA, h=40 cm	nogice za omariče, h=40 cm, (par) noge za ormariče, h=40 cm, (par)	3838987 505921	62,00

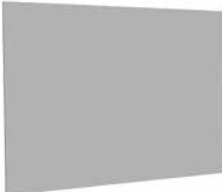



Model	Naziv in dimenzija izdelka Naziv i dimenzije produkta	Opis Opis	EAN koda EAN koda	Cena EUR Cijena EUR
OG Ø 150 -LED, IR, DIM				
	OG Ø 150 (Ø 120 + Ø 80) -LED, IR, DIM (2 ogledala /ogledala, 3 lučke/svjetla) 1500 x 1200 x 30	ogledalo z LED svetilko, senzorsko stikalo (IR), regulator intenzivnosti svetlobe (DIM) ogledalo sa LED svjetlom, senzorski prekidač (IR), regulator intenzivnosti svjetla (DIM) NEUTRAL WHITE	3838987 546450	510,00
OG Ø 120, 100, 80 -LED, IR, DIM				
	OG Ø 120 -LED, IR, DIM (2 lučki/svjetla) OG Ø 100 -LED, IR, DIM OG Ø 80 -LED, IR, DIM	ogledalo z LED svetilko, senzorsko stikalo (IR), regulator intenzivnosti svetlobe (DIM) ogledalo sa LED svjetlom, senzorski prekidač (IR), regulator intenzivnosti svjetla (DIM) NEUTRAL WHITE	3838987 573708 3838987 573692 3838987 573685	380,00 285,00 253,00
OG 100, 80, -LED, T				
	OG 100 -LED, T 1000 x 700 x 20 OG 80 -LED, T 800 x 700 x 20	ogledalo z integrirano ambientalno LED svetilko, senzorsko stikalo (T) ogledalo s integriranim ambientalnim LED svjetlom, senzorski prekidač (T) NEUTRAL WHITE	3838987 507260 3838987 507253	311,00 275,00
OG 120, OG 90 -LED, T, C				
	OG 120 -LED, T, C 1200 x 700 x 20 OG 90 -LED, T, C 900 x 700 x 20	ogledalo z integrirano LED svetilko in uro (C), senzorsko stikalo (T) ogledalo sa integriranim LED svjetlom i satom (C), senzorski prekidač (T) NEUTRAL WHITE	3838987 507819 3838987 507802	341,00 289,00
OG 150, 120, 100, 90, 80, 70				
	OG 150 1500 x 700 x 20 OG 120 1200 x 700 x 20 OG 100 1000 x 700 x 20 OG 90 900 x 700 x 20 OG 80 800 x 700 x 20 OG 70 700 x 700 x 20	ogledalo, pravokotno ogledalo, pravokutno	3838987 547419 3838987 546443 3838987 547402 3838987 547396 3838987 546436 3838987 546412	123,00 108,00 94,00 88,00 83,00 76,00

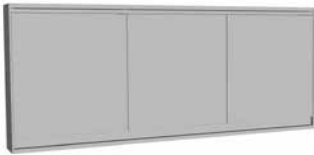

Model	Naziv in dimenzija izdelka Naziv i dimenzije produkta	Opis Opis	EAN koda EAN koda	Cena EUR Cijena EUR
POLICA OG 150, 120, 100, 90, 80, 70				
 	POLICA OG 150 WH 1505 x 22 x 120	polica za pravokotno ogledalo s konzolo polica za pravokotnu ogledalo s konzolom	3838987 547471	72,00
	POLICA OG 120 WH 1205 x 22 x 120		3838987 546474	65,00
	POLICA OG 100 WH 1005 x 22 x 120		3838987 547464	58,00
	POLICA OG 90 WH 905 x 22 x 120		3838987 547457	55,00
	POLICA OG 80 WH 805 x 22 x 120		3838987 547440	51,00
	POLICA OG 70 WH 705 x 22 x 120		3838987 547433	47,00
KOZMETIČNO OGLEDALO				
	KOZMETIČNO OGLEDALO	ogledalo, okroglo ogledalo, okroglo	3838987 546535	110,00
TOP 150 -LED, SW, S				
	TOP 150 WH -LED, SW, S 1500 x 604 x 140	toaletna omarica z LED svetilko, stikalo (SW), vtičnica (S) toaletni ormarič s LED svetlom, prekidač (SW), utičnica (S) NEUTRAL WHITE	3838987 514268	818,00
TOP 110 -LED, SW, S				
	TOP 110 WH -LED, SW, S 1100 x 604 x 140	toaletna omarica z LED svetilko, stikalo (SW), vtičnica (S) toaletni ormarič s LED svetlom, prekidač (SW), utičnica (S) NEUTRAL WHITE	3838987 514251	619,00
TOP 75 -LED, SW, S				
	TOP 75 WH -LED, SW, S 750 x 604 x 140	toaletna omarica z LED svetilko, stikalo (SW), vtičnica (S) toaletni ormarič s LED svetlom, prekidač (SW), utičnica (S) NEUTRAL WHITE	3838987 514244	525,00

Kopalniško pohištvo
Kupaonski namještaj









Program: PANDORA

Umivalnik: liti marmor, obod: MDF lakiran, WH, vrata: lakiran MDF bela (WH); opl. iver. pljesen (NA), opl. iver. pl. črni kamen (BLACK STONE) / umivaonik: lijevani marmor, obod: MDF lakiran, WH, vrata: lakiran MDF bijela (WH); oplemenjena iverica jasen (NA); oplemenjena iverica crni kamen (BLACK STONE)

kolpa·san

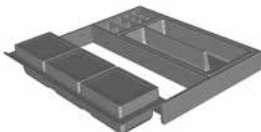
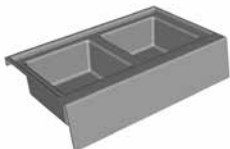



Model	Naziv in dimenzija izdelka Naziv i dimenzije produkta	Opis Opis	EAN koda EAN koda	Cena EUR Cijena EUR
OUP 150				
  x 2	OUP 150 WH	omarica z dvojnimi umivalnikom ormarič sa duplim umivaonikom Priložen spodnji del sifona/ Uključen donji dio sifona	3838987 514176	751,00
	OUP 150 NA		3838987 514206	751,00
	OUP 150 BLACK STONE		3838987 514237	751,00
OUP 110				
 	OUP 110 WH	omarica z umivalnikom ormarič s umivaonikom Priložen spodnji del sifona/ Uključen donji dio sifona	3838987 514169	581,00
	OUP 110 NA		3838987 514190	581,00
	OUP 110 BLACK STONE		3838987 514220	581,00
OUP 75				
 	OUP 75 WH	omarica z umivalnikom ormarič s umivaonikom Priložen spodnji del sifona/ Uključen donji dio sifona	3838987 514152	509,00
	OUP 75 NA		3838987 514183	509,00
	OUP 75 BLACK STONE		3838987 514213	509,00
P 1302				
	P 1302 WH	omarica z vratima ormarič sa vratima	3838987 514305	351,00
	P 1302 NA		3838987 514312	351,00
	P 1302 BLACK STONE		3838987 514329	351,00
P 1301				
	P 1301 WH	omarica z vratima in predaloma ormarič sa vratima i ladicama	3838987 514275	416,00
	P 1301 NA		3838987 514282	416,00
	P 1301 BLACK STONE		3838987 514299	416,00



Model	Naziv in dimenzija izdelka Naziv i dimenzije produkta	Opis Opis	EAN koda EAN koda	Cena EUR Cijena EUR
LUČ 700, 500 BL -LED				
 	LUČ 700 BL -LED L=700	Svetilka (LED) za OG	3838987 547518	95,00
	LUČ 500 BL -LED L=500	Svjetlo (LED) za OG NEUTRAL WHITE	3838987 546542	88,00
LUČ 300 -LED				
 	LUČ 300 -LED L = 300	svetilka (LED) brez vtičnice in stikala za OG svjetlo (LED) bez utičnice i prekidača za OG NEUTRAL WHITE	3838987 509974	53,00
ORGANIZATOR PREDALA				
	ORGANIZATOR PREDALA ZG.400	za zgornji predal za gornju ladicu	3838987 529460	45,00
	ORGANIZATOR PREDALA SP.400	za spodnji predal za donju ladicu	3838987 529484	45,00
	KOZMETIČNI KOŠ 174 x 232 x 174	za spodnji predal za donju ladicu	3838987 529507	20,00
NOGICE POHIŠTVA				
 	NOGICE POHIŠTVA, h=40 cm	nogice za omarice, h=40 cm, (par) noge za ormariće, h=40 cm, (par)	3838987 505921	62,00

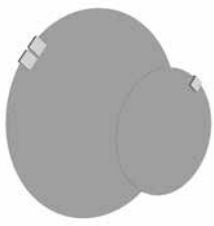

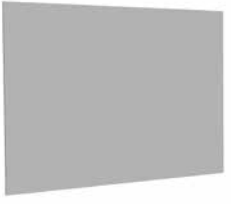

Model	Naziv in dimenzija izdelka Naziv i dimenzije produkta	Opis Opis	EAN koda EAN koda	Cena EUR Cijena EUR
OG Ø 150 -LED, IR, DIM				
	OG Ø 150 (Ø 120 + Ø 80) -LED, IR, DIM (2 ogledala /ogledala, 3 lučke/svjetla) 1500 x 1200 x 30	ogledalo z LED svetilko, senzorsko stikalo (IR), regulator intenzivnosti svetlobe (DIM) ogledalo sa LED svjetlom, senzorski prekidač (IR), regulator intenzivnosti svjetla (DIM) NEUTRAL WHITE	3838987 546450	510,00
OG Ø 120, 100, 80 -LED, IR, DIM				
	OG Ø 120 -LED, IR, DIM (2 lučki/svjetla) OG Ø 100 -LED, IR, DIM OG Ø 80 -LED, IR, DIM	ogledalo z LED svetilko, senzorsko stikalo (IR), regulator intenzivnosti svetlobe (DIM) ogledalo sa LED svjetlom, senzorski prekidač (IR), regulator intenzivnosti svjetla (DIM) NEUTRAL WHITE	3838987 573708 3838987 573692 3838987 573685	380,00 285,00 253,00
OG 100, 80, -LED, T				
	OG 100 -LED, T 1000 x 700 x 20 OG 80 -LED, T 800 x 700 x 20	ogledalo z integrirano ambientalno LED svetilko, senzorsko stikalo (T) ogledalo s integriranim ambientalnim LED svjetlom, senzorski prekidač (T) NEUTRAL WHITE	3838987 507260 3838987 507253	311,00 275,00
OG 120, OG 90 -LED, T, C				
	OG 120 -LED, T, C 1200 x 700 x 20 OG 90 -LED, T, C 900 x 700 x 20	ogledalo z integrirano LED svetilko in uro (C), senzorsko stikalo (T) ogledalo sa integriranim LED svjetlom i satom (C), senzorski prekidač (T) NEUTRAL WHITE	3838987 507819 3838987 507802	341,00 289,00
OG 150, 120, 100, 90, 80, 70				
	OG 150 1500 x 700 x 20 OG 120 1200 x 700 x 20 OG 100 1000 x 700 x 20 OG 90 900 x 700 x 20 OG 80 800 x 700 x 20 OG 70 700 x 700 x 20	ogledalo, pravokotno ogledalo, pravokutno	3838987 547419 3838987 546443 3838987 547402 3838987 547396 3838987 546436 3838987 546412	123,00 108,00 94,00 88,00 83,00 76,00







Kopalniško pohištvo
Kupaonski namještaj

Program: BLANCHE







Umivalnik: liti marmor (WH, WH/ANT)/kerrock plošča, vrata: MDF oplasčen s 3D folijo barva: bela mat (WH), antracit (ANT) / umivaonik: lijevani mramor (WH, WH/ANT)/kerrock ploča, vrata: MDF prevučeni s 3D folijom, boja: bijela mat (WH), antracit (ANT)

kolpa-san

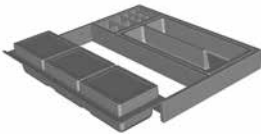
Model	Naziv in dimenzija izdelka Naziv i dimenzije produkta	Opis Opis	EAN koda EAN koda	Cena EUR Cijena EUR
POLICA OG 150, 120, 100, 90, 80, 70				
	<p>POLICA OG 150 WH 1505 x 22 x 120</p> <p>POLICA OG 120 WH 1205 x 22 x 120</p> <p>POLICA OG 100 WH 1005 x 22 x 120</p> <p>POLICA OG 90 WH 905 x 22 x 120</p> <p>POLICA OG 80 WH 805 x 22 x 120</p> <p>POLICA OG 70 WH 705 x 22 x 120</p>	<p>polica za pravokotno ogledalo s konzolo</p> <p>polica za pravokutnu ogledalo s konzolom</p>	<p>3838987 547471</p> <p>3838987 546474</p> <p>3838987 547464</p> <p>3838987 547457</p> <p>3838987 547440</p> <p>3838987 547433</p>	<p>72,00</p> <p>65,00</p> <p>58,00</p> <p>55,00</p> <p>51,00</p> <p>47,00</p>
KOZMETIČNO OGLEDALO				
	KOZMETIČNO OGLEDALO Ø 25	povečevalno ogledalo, okroglo uvečavajuće ogledalo, okruglo	3838987 546535	110,00
TOB 145 -LED, SW, S				
	<p>TOB 145 WH -LED, SW, S</p> <p>TOB 145 ANT -LED, SW, S</p> <p>1450 x 700 x 142</p>	<p>toaletna omarica z LED svetilko, stikalo (SW), vtičnica (S)</p> <p>toaletni ormarič s LED svjetlom, prekidač (SW), utičnica (S)</p> <p>NEUTRAL WHITE</p>	<p>3838987 561170</p> <p>3838987 561569</p>	<p>507,00</p> <p>507,00</p>
TOB 95 -LED, SW, S				
	<p>TOB 95 WH -LED, SW, S</p> <p>TOB 95 ANT -LED, SW, S</p> <p>950 x 700 x 142</p>	<p>toaletna omarica z LED svetilko, stikalo (SW), vtičnica (S)</p> <p>toaletni ormarič s LED svjetlom, prekidač (SW), utičnica (S)</p> <p>NEUTRAL WHITE</p>	<p>3838987 538851</p> <p>3838987 561552</p>	<p>397,00</p> <p>397,00</p>
TOB 70 -LED, SW, S				
	<p>TOB 70 WH -LED, SW, S</p> <p>TOB 70 ANT -LED, SW, S</p> <p>700 x 700 x 142</p>	<p>toaletna omarica z LED svetilko, stikalo (SW), vtičnica (S)</p> <p>toaletni ormarič s LED svjetlom, prekidač (SW), utičnica (S)</p> <p>NEUTRAL WHITE</p>	<p>3838987 561811</p> <p>3838987 561828</p>	<p>351,00</p> <p>351,00</p>







Model	Naziv in dimenzija izdelka Naziv i dimenzije produkta	Opis Opis	EAN koda EAN koda	Cena EUR Cijena EUR
UB 530 ON WH - UMIV. BLA.				
	UB 530 ON WH - UMIVALNIK BLANCHE	umivalnik iz litega marmorja umivaonik od lijevanog mramora Priložen zgornji del sifona/ Ukjučen gornji dio sifona	3838987 563266	238,00
	UB 530 ON WH/ANT - UMIVALNIK BLANCHE		3838987 563273	294,00
OB 150				
	OB 150 WH	podumivalniška omarica s predalom in kerrock odlagalno površino / element ispod umivaonika s ladicom i površinom za odlaganje od Kerrocka Ni izvrtine za armaturo / Nema rupe za armaturu 1488 x 280 x 525	3838987 547723	818,00
	OB 150 ANT		3838987 547730	818,00
OB 110				
	OB 110 WH	podumivalniška omarica s predalom in kerrock odlagalno površino / element ispod umivaonika s ladicom i površinom za odlaganje od Kerrocka Ni izvrtine za armaturo / Nema rupe za armaturu 1088 x 280 x 525	3838987 547709	576,00
	OB 110 ANT		3838987 547716	576,00
OB 75				
	OB 75 WH	podumivalniška omarica s predalom in kerrock odlagalno površino / element ispod umivaonika s ladicom i površinom za odlaganje od Kerrocka Ni izvrtine za armaturo / Nema rupe za armaturu 688 x 280 x 525	3838987 547686	479,00
	OB 75 ANT		3838987 547693	479,00
B 1323				
	B 1323 WH	omarica z vratima ormarič sa vratima 454 x 1321 x 300	3838987 514145	252,00
	B 1323 ANT		3838987 514121	252,00







Model	Naziv in dimenzija izdelka Naziv i dimenzije produkta	Opis	EAN koda EAN koda	Cena EUR Cijena EUR
B 923				
	B 923 WH	omariča z vrati ormarič sa vratima	3838987 514114	227,00
	B 923 ANT		3838987514091	227,00
	454 x 918 x 300			
ORGANIZATOR PREDALA				
	ORGANIZATOR PREDALA ZG.400	za zgornji predal za gornju ladicu	3838987 529460	45,00
LUČ 700, 500 BL -LED				
 	LUČ 700 BL -LED L=700	Svetilka (LED) za OG Svjetlo (LED) za OG NEUTRAL WHITE	3838987 547518	95,00
	LUČ 500 BL -LED L=500		3838987 546542	88,00
LUČ 300 -LED				
 	LUČ 300 -LED	svetilka (LED) brez vtičnice in stikala za OG svjetlo (LED) bez utičnice i prekidača za OG NEUTRAL WHITE	3838987 509974	53,00
	L = 300			
NOGICE POHIŠTVA				
 	NOGICE POHIŠTVA, h=40 cm	nogice za omariče, h=40 cm, (par) noge za ormariče, h=40 cm, (par)	3838987 505921	62,00





Model	Naziv in dimenzija izdelka Naziv i dimenzije produkta	Opis Opis	EAN koda EAN koda	Cena EUR Cijena EUR
OG Ø 120, 100, 80 -LED, IR, DIM				
	OG Ø 120 -LED, IR, DIM (2 lučki/svjetla)	ogledalo z LED svetilko, senzorsko stikalo (IR), regulator intenzivnosti svetlobe (DIM) ogledalo sa LED svjetlom, senzorski prekidač (IR), regulator intenzivnosti svjetla (DIM) NEUTRAL WHITE	3838987 573708	380,00
	OG Ø 100 -LED, IR, DIM		3838987 573692	285,00
	OG Ø 80 -LED, IR, DIM		3838987 573685	253,00
OG 100, 80, 60 -LED, T				
	OG 100 -LED, T 1000 x 700 x 20	ogledalo z integrirano ambientalno LED svetilko, senzorsko stikalo (T) ogledalo s integriranim ambientalnim LED svjetlom, senzorski prekidač (T) NEUTRAL WHITE	3838987 507260	311,00
	OG 80 -LED, T 800 x 700 x 20		3838987 507253	275,00
	OG 60 -LED, T 600 x 700 x 20		3838987 507246	254,00
OG 120, OG 90 -LED, T, C				
	OG 120 -LED, T, C 1200 x 700 x 20	ogledalo z integrirano LED svetilko in uro (C), senzorsko stikalo (T) ogledalo sa integriranim LED svjetlom i satom (C), senzorski prekidač (T) NEUTRAL WHITE	3838987 507819	341,00
	OG 90 -LED, T, C 900 x 700 x 20		3838987 507802	289,00
OG 120, 100, 90, 80, 70, 60, 50				
	OG 120 1200 x 700 x 20	ogledalo, pravokotno ogledalo, pravokutno	3838987 546443	108,00
	OG 100 1000 x 700 x 20		3838987 547402	94,00
	OG 90 900 x 700 x 20		3838987 547396	88,00
	OG 80 800 x 700 x 20		3838987 546436	83,00
	OG 70 700 x 700 x 20		3838987 546412	76,00
	OG 60 600 x 700 x 20		3838987 547389	72,00
	OG 50 500 x 700 x 20		3838987 546405	59,00
POLICA OG 120, 100, 80, 60, 50				
 	POLICA OG 120 WH 1205 x 22 x 120	polica za pravokotno ogledalo s konzolo polica za pravokutnu ogledalo s konzolom	3838987 546474	65,00
	POLICA OG 100 WH 1005 x 22 x 120		3838987 547464	58,00
	POLICA OG 90 WH 905 x 22 x 120		3838987 547457	55,00
	POLICA OG 80 WH 805 x 22 x 120		3838987 547440	51,00
	POLICA OG 70 WH 705 x 22 x 120		3838987 547433	47,00
	POLICA OG 60 WH 605 x 22 x 120		3838987 547426	45,00
	POLICA OG 50 WH 505 x 22 x 120		3838987 546467	42,00







Model	Naziv in dimenzija izdelka Naziv i dimenzije produkta	Opis Opis	EAN koda EAN koda	Cena EUR Cijena EUR
KOZMETIČNO OGLEDALO				
	KOZMETIČNO OGLEDALO Ø 25	povečevalno ogledalo, okroglo uvečavajuće ogledalo, okruglo	3838987 546535	110,00
TON 120, 100				
	TON 120 WH 1200 x 700 x 130	toaletna omarica toaletni ormarič	3838987 546825	237,00
	TON 120 NW		3838987 546832	237,00
	TON 120 DC		3838987 546849	237,00
	TON 100 WH 1000 x 700 x 130	toaletna omarica toaletni ormarič	3838987 546801	213,00
	TON 100 NW		3838987 546078	213,00
	TON 100 DC		3838987 546085	213,00
TON 80, 70				
	TON 80 WH 800 x 700 x 130	toaletna omarica toaletni ormarič	3838987 546771	179,00
	TON 80 NW		3838987 546788	179,00
	TON 80 DC		3838987 546795	179,00
	TON 70 WH 700 x 700 x 130	toaletna omarica toaletni ormarič	3838987 546740	169,00
	TON 70 NW		3838987 546757	169,00
	TON 70 DC		3838987 546764	169,00
TON 60, 50				
	TON 60 WH 600 x 700 x 130	toaletna omarica toaletni ormarič	3838987 546726	131,00
	TON 60 NW		3838987 546061	131,00
	TON 60 DC		3838987 546733	131,00
	TON 50 WH 500 x 700 x 130	toaletna omarica toaletni ormarič	3838987 546696	125,00
	TON 50 NW		3838987 546702	125,00
	TON 50 DC		3838987 546719	125,00
OUN 120				
	OUN 120 WH	omarca z umivalnikom ormarič s umivaonikom	3838987 546672	518,00
	OUN 120 NW		3838987 546689	518,00
	OUN 120 DC		3838987 546054	518,00
	1200 x 495 x 450	Priložen spodnji del sifona/ Uključen donji dio sifona		

Kopalniško pohištvo
Kupaonski namještaj

Program: NAOMI

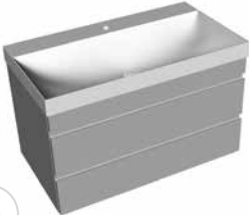



Fronte: MDF oplasčen s 3D folijo v dekorju – White (WH), Dark Concrete (DC), Natural Wood (NW) Obod:
Oplemenitena iverna plošča v dekorju - White (WH), Dark Concrete (DC), Natural Wood (NW) Umivalnik:
Liti Marmor / Fronte: MDF presvučena s 3D folijom u dekoru – White (WH), Dark Concrete (DC), Natural Wood (NW) Obod:
presvučena oplemenjena iverna ploča u dekoru - White (WH), Dark Concrete (DC), Natural Wood (NW) Umivaonik: Ljevani Mramor

kolpa-san

Model	Naziv in dimenzija izdelka Naziv i dimenzije produkta	Opis Opis	EAN koda EAN koda	Cena EUR Cijena EUR
OUN 100				
	OUN 100 WH	ormarica z umivalnikom ormarič s umivaonikom Priložen spodnji del sifona/ Uključen donji dio sifona	3838987 546658	463,00
	OUN 100 NW		3838987 546047	463,00
	OUN 100 DC		3838987 546665	463,00
OUN 80				
	OUN 80 WH	ormarica z umivalnikom ormarič s umivaonikom Priložen spodnji del sifona/ Uključen donji dio sifona	3838987 546030	437,00
	OUN 80 NW		3838987 546634	437,00
	OUN 80 DC		3838987 546641	437,00
OUN 70				
	OUN 70 WH	ormarica z umivalnikom ormarič s umivaonikom Priložen spodnji del sifona/ Uključen donji dio sifona	3838987 546610	403,00
	OUN 70 NW		3838987 546627	403,00
	OUN 70 DC		3838987 546023	403,00
OUN 60				
	OUN 60 WH	ormarica z umivalnikom ormarič s umivaonikom Priložen spodnji del sifona/ Uključen donji dio sifona	3838987 546597	389,00
	OUN 60 NW		3838987 546016	389,00
	OUN 60 DC		3838987 546603	389,00
OUN 50				
	OUN 50 WH	ormarica z umivalnikom ormarič s umivaonikom Priložen spodnji del sifona/ Uključen donji dio sifona	3838987 546009	349,00
	OUN 50 NW		3838987 546573	349,00
	OUN 50 DC		3838987 546580	349,00

Kopalniško pohištvo
Kupaonski namještaj

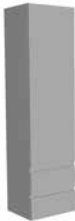

Model	Naziv in dimenzija izdelka Naziv i dimenzije produkta	Opis Opis	EAN koda EAN koda	Cena EUR Cijena EUR
ON 60				
	ON 60 WH	omarica s predaloma ormarič sa ladicama	3838987 546146	217,00
	ON 60 NW		3838987 546955	217,00
	ON 60 DC		3838987 546962	217,00
	590 x 325 x 454			
ON 40				
	ON 40 WH	omarica z vratima ormarič sa vratima	3838987 546917	118,00
	ON 40 NW		3838987 546122	118,00
	ON 40 DC		3838987 546924	118,00
	400 x 454 x 325			
N 1501/790				
	N 1501/790 WH	omarica z vratima in predaloma ormarič sa vratima i ladicama	3838987 546856	387,00
	N 1501/790 NW		3838987 546863	387,00
	N 1501/790 DC		3838987 546092	387,00
	790 x 1495 x 320			
N 1501				
	N 1501 WH	omarica z vratima in predaloma ormarič sa vratima i ladicama	3838987 546108	293,00
	N 1501 NW		3838987 546870	293,00
	N 1501 DC		3838987 546887	293,00
	400 x 1495 x 320			
N 1500/30				
	N 1500/30 WH	odprta omarica otvoren ormarič	3838987 546894	143,00
	N 1500/30 NW		3838987 546900	143,00
	N 1500/30 DC		3838987 546115	143,00
	300 x 1495 x 320			

Kopalniško pohištvo
Kupaonski namještaj

Program: NAOMI

Fronte: MDF opláčen s 3D folijo v dekorju – White (WH), Dark Concrete (DC), Natural Wood (NW) Obod:
Oplemenitena iverna plošča v dekorju - White (WH), Dark Concrete (DC), Natural Wood (NW) Umivalnik:
Liti Marmor / Fronte: MDF presvučena s 3D folijom u dekoru – White (WH), Dark Concrete (DC), Natural Wood (NW) Obod:
presvučena oplemenjena iverna ploča u dekoru - White (WH), Dark Concrete (DC), Natural Wood (NW) Umivaonik: Ljevani Mramor

kolpa-san

Model	Naziv in dimenzija izdelka Naziv i dimenzije produkta	Opis Opis	EAN koda EAN koda	Cena EUR Cijena EUR
N 702/600/20				
	N 702/600/20 WH	omarica z vrati ormarič sa vratima	3838987 546153	122,00
	N 702/600/20 NW		3838987 546979	122,00
	N 702/600/20 DC		3838987 546986	122,00
	590 x 700 x 200			
N 702/20				
	N 702/20 WH	omarica z vrati ormarič sa vratima	3838987 546931	107,00
	N 702/20 NW		3838987 546139	107,00
	N 702/20 DC		3838987 546948	107,00
	400 x 700 x 200			
N 700/13				
	N 700/13 WH	odprta omarica otvoren ormarič	3838987 546160	59,00
	N 700/13 NW		3838987 546177	59,00
	N 700/13 DC		3838987 546993	59,00
	200 x 700 x 130			
LUČ 700, 500 BL BOX-LED, SW, S				
 	LUČ 700 BL BOX -LED, SW, S L=700	Svetilka (LED), stikalo (SW), vtičnica (S), BOX za TON / Svjetlo (LED), prekidač (SW), utičnica (S), BOX za TON	3838987 546566	129,00
	LUČ 500 BL BOX -LED, SW, S L=500		3838987 546559	122,00
		NEUTRAL WHITE		
LUČ 700, 500 BL -LED				
 	LUČ 700 BL -LED L=700	Svetilka (LED) za OG in TON Svjetlo (LED) za OG i TON	3838987 547518	95,00
	LUČ 500 BL -LED L=500		3838987 546542	88,00
		NEUTRAL WHITE		





Kopalniško pohištvo

Kupaonski namještaj

Program: NAOMI

Fronte: MDF oplasčen s 3D folijo v dekorju – White (WH), Dark Concrete (DC), Natural Wood (NW) Obod:
Oplemenitena iverna plošča v dekorju - White (WH), Dark Concrete (DC), Natural Wood (NW) Umivalnik:
Liti Marmor / Fronte: MDF presvučena s 3D folijom u dekoru – White (WH), Dark Concrete (DC), Natural Wood (NW) Obod:
presvučena oplemenjena iverna ploča u dekoru - White (WH), Dark Concrete (DC), Natural Wood (NW) Urnivaonik: Ljevani Mramor

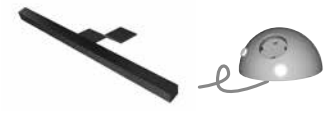
kolpa-san

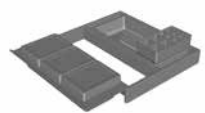
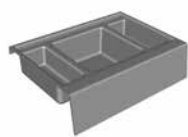
Model	Naziv in dimenzija izdelka Naziv i dimenzije produkta	Opis Opis	EAN koda EAN koda	Cena EUR Cijena EUR
LUČ 500 BOX -LED, SW, S				
	LUČ 500 BOX -LED, SW, S L = 500	svetilka (LED), stikalo (SW), vtičnica (S), BOX za toaletno omarico TON /svjetlo (LED), prekidač (SW), utičnica (S), BOX za toaletni omarič TON NEUTRAL WHITE	3838987 300298	116,00
LUČ 300 -LED				
	LUČ 300 -LED L = 300	svetilka (LED) brez vtičnice in stikala za TON in OG svjetlo (LED) bez utičnice i prekidača za TON i OG NEUTRAL WHITE	3838987 509974	53,00
ORGANIZATOR PREDALA				
	ORGANIZATOR PREDALA ZG.350	za zgornji predal pri OUN 120 za gornju ladicu kod OUN 120	3838987 529477	40,00
	ORGANIZATOR PREDALA SP.350	za spodnji predal za donju ladicu Samo za: OUN 120, 100, 80, 70, 60	3838987 529491	43,00











Kopalniško pohištvo

Kupaonski namještaj

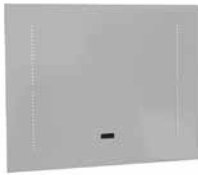
Program: TARA

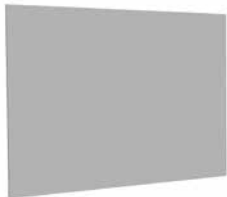
Umivalnik: liti marmor, vrata: MDF oplaćen s 3D folijo, barva: bela-mat (WH), craftwood (CW), umivaonik: lijevani mramor, vrata: MDF prevučeni s 3D folijom, boja: bijela-mat (WH), craftwood (CW)

kolpa-san

Model	Naziv in dimenzija izdelka Naziv i dimenzije produkta	Opis Opis	EAN koda EAN koda	Cena EUR Cijena EUR
OG 120, OG 90 -LED, T, C				
	OG 120 -LED, T, C 1200 x 700 x 20	ogledalo z integrirano LED svetilko in uro (C), senzorsko stikalo (T) ogledalo sa integriranim LED svjetlom i satom (C), senzorski prekidač (T) NEUTRAL WHITE	3838987 507819	341,00
	OG 90 -LED, T, C 900 x 700 x 20		3838987 507802	289,00
OG 100, 80, 60 -LED, T				
	OG 100 -LED, T 1000 x 700 x 20	ogledalo z integrirano ambientalno LED svetilko, senzorsko stikalo (T) ogledalo s integriranim ambientalnim LED svjetlom, senzorski prekidač (T) NEUTRAL WHITE	3838987 507260	311,00
	OG 80 -LED, T 800 x 700 x 20		3838987 507253	275,00
	OG 60 -LED, T 600 x 700 x 20		3838987 507246	254,00
OG 120, 100, 90, 80, 70, 60				
	OG 120 1200 x 700 x 20	ogledalo, pravokotno ogledalo, pravokutno	3838987 546443	108,00
	OG 100 1000 x 700 x 20		3838987 547402	94,00
	OG 90 900 x 700 x 20		3838987 547396	88,00
	OG 80 800 x 700 x 20		3838987 546436	83,00
	OG 70 700 x 700 x 20		3838987 546412	76,00
	OG 60 600 x 700 x 20		3838987 547389	72,00
POLICA OG 120, 100, 90, 80, 70, 60				
 	POLICA OG 120 WH 1205 x 22 x 120	polica za pravokotno ogledalo s konzolo polica za pravokutnu ogledalo s konzolom	3838987 546474	65,00
	POLICA OG 100 WH 1005 x 22 x 120		3838987 547464	58,00
	POLICA OG 90 WH 905 x 22 x 120		3838987 547457	55,00
	POLICA OG 80 WH 805 x 22 x 120		3838987 547440	51,00
	POLICA OG 70 WH 705 x 22 x 120		3838987 547433	47,00
	POLICA OG 60 WH 605 x 22 x 120		3838987 547426	45,00
KOZMETIČNO OGLEDALO				
	KOZMETIČNO OGLEDALO	ogledalo, okroglo ogledalo, okruglo	3838987 546535	110,00

Kopalniško pohištvo
Kupaonski namještaj







Kopalniško pohištvo
 Kupaonski namještaj

Program: TARA

 Umivalnik: liti marmor, vrata: MDF oplasčen s 3D folijo, barva: bela-mat (WH),
 craftwood (CW), umivaonik: lijevani mramor, vrata: MDF prevučeni s 3D folijom, boja:
 bijela-mat (WH), craftwood (CW)

kolpa-san®







Model	Naziv in dimenzija izdelka Naziv i dimenzije produkta	Opis Opis	EAN koda EAN koda	Cena EUR Cijena EUR
TO 110 -LED, SW, S				
	TO 110 WH -LED, SW, S	toaletna omarica z LED svetilko, stikalo (SW), vtičnica (S) toaletni ormarič s LED svjetlom, prekidač (SW), utičnica (S) NEUTRAL WHITE	3838987 507468	531,00
	TO 110 CW -LED, SW, S		3838987 547778	531,00
1104 x 718 x 170				
TO 90 -LED, SW, S				
	TO 90 WH -LED, SW, S	toaletna omarica z LED svetilko, stikalo (SW), vtičnica (S) toaletni ormarič s LED svjetlom, prekidač (SW), utičnica (S) NEUTRAL WHITE	3838987 507437	450,00
	TO 90 CW -LED, SW, S		3838987 547761	450,00
904 x 718 x 170				
TO 70 -LED, SW, S				
	TO 70 WH -LED, SW, S	toaletna omarica z LED svetilko, stikalo (SW), vtičnica (S) toaletni ormarič s LED svjetlom, prekidač (SW), utičnica (S) NEUTRAL WHITE	3838987 528425	353,00
	TO 70 CW -LED, SW, S		3838987 547754	353,00
704 x 718 x 170				
OUT 110				
	OUT 110 WH	omariča z umivalnikom ormarič s umivaonikom Priložen spodnji del sifona/ Uključen donji dio sifona	3838987 528395	689,00
	OUT 110 CW		3838987 547549	689,00
1110 x 495 x 450				
OUT 90				
	OUT 90 WH	omariča z umivalnikom ormarič s umivaonikom Priložen spodnji del sifona/ Uključen donji dio sifona	3838987 528371	609,00
	OUT 90 CW		3838987 547532	609,00
910 x 495 x 450				

Model	Naziv in dimenzija izdelka Naziv i dimenzije produkta	Opis Opis	EAN koda EAN koda	Cena EUR Cijena EUR
OUT 70				
	OUT 70 WH	omara z umivalnikom ormarič s umivaonikom Priložen spodnji del sifona/ Uključen donji dio sifona	3838987 528340	553,00
	OUT 70 CW		3838987 547525	553,00
710 x 495 x 450				
T 1501				
	T 1501 WH	omara z vrati in predaloma ormarič sa vratima i ladicama	3838987 528494	354,00
	T 1501 CW		3838987 547570	354,00
450 x 1500 x 320				
T 712/20				
	T 712/20 WH	omara z vrati ormarič sa vratima	3838987 528517	120,00
	T 712/20 CW		3838987 547563	120,00
450 x 712 x 200				
OT 45				
	OT 45 WH	omara s predaloma ormarič sa ladicama	3838987 528531	384,00
	OT 45 CW		3838987 547556	384,00
456 x 480 x 321				
ORGANIZATOR PREDALA				
	ORGANIZATOR PREDALA ZG.350	za zgornji predal za gornju ladicu	3838987 529477	40,00

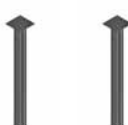

Kopalniško pohištvo
Kupaonski namještaj**Program: TARA**Umivalnik: liti marmor, vrata: MDF oplasčen s 3D folijo, barva: bela-mat (WH),
craftwood (CW), umivaonik: lijevani mramor, vrata: MDF prevučeni s 3D folijom, boja:
bijela-mat (WH), craftwood (CW)

kolpa-san®

Model	Naziv in dimenzija izdelka Naziv i dimenzije produkta	Opis Opis	EAN koda EAN koda	Cena EUR Cijena EUR
LUČ 700, 500 BL -LED				
 	LUČ 700 BL -LED L=700	Svetilka (LED) za OG Svjetlo (LED) za OG NEUTRAL WHITE	3838987 547518	95,00
	LUČ 500 BL -LED L=500		3838987 546542	88,00
LUČ 300 -LED				
 	LUČ 300 -LED L = 300	svetilka (LED) brez vtičnice in stikala za OG svjetlo (LED) bez utičnice i prekidača za OG NEUTRAL WHITE	3838987 509974	53,00
NOGICE POHIŠTVA				
 	NOGICE POHIŠTVA, h=40 cm	nogice za ormarice, h=40 cm, (par) noge za ormariče, h=40 cm, (par)	3838987 505921	62,00











Kopalniško pohištvo

Kupaonski namještaj

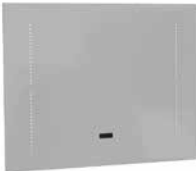
Program: DONNA

Umivalnik: a) liti marmor (LM) / b) keramični, vgrajen v Kerrock ploščo (KER); vrata - lakirani MDF, bela (WH); obod - lakirani MDF, črna (BL), BEIGE, umivaonik: a) lijevani marmor (LM) / b) keramički, ugrajen u Kerrock plošču; vrata - lakirani MDF bijela (WH); obod - lakirani MDF, črna (BL), BEIGE

kolpa-san

Model	Naziv in dimenzija izdelka Naziv i dimenzije produkta	Opis Opis	EAN koda EAN koda	Cena EUR Cijena EUR	
OG 100, 80, 60 -LED, T					
	OG 100 -LED, T	1000 x 700 x 20	ogledalo z integrirano ambientalno LED svetilko, senzorsko stikalo (T)	3838987 507260	311,00
	OG 80 -LED, T	800 x 700 x 20	ogledalo s integriranim ambientalnim LED svetlom, senzorski prekidač (T)	3838987 507253	275,00
	OG 60 -LED, T	600 x 700 x 20		3838987 507246	254,00
NEUTRAL WHITE					
OG 120, OG 90 -LED, T, C					
	OG 120 -LED, T, C	1200 x 700 x 20	ogledalo z integrirano LED svetilko in uro (C), senzorsko stikalo (T)	3838987 507819	341,00
	OG 90 -LED, T, C	900 x 700 x 20	ogledalo sa integriranim LED svjetlom i satom (C), senzorski prekidač (T)	3838987 507802	289,00
NEUTRAL WHITE					
OG 100, 80, 60					
	OG 100	1000 x 700 x 20	ogledalo, pravokotno	3838987 547402	94,00
	OG 80	800 x 700 x 20	ogledalo, pravokutno	3838987 546436	83,00
	OG 60	600 x 700 x 20		3838987 547389	72,00
POLICA OG 100, 80, 60					
	POLICA OG 100 WH	1005 x 22 x 120	polica za pravokotno ogledalo s konzolo	3838987 547464	58,00
	POLICA OG 80 WH	805 x 22 x 120	polica za pravokutnu ogledalo s konzolom	3838987 547440	51,00
	POLICA OG 60 WH	605 x 22 x 120		3838987 547426	45,00
KOZMETIČNO OGLEDALO					
	KOZMETIČNO OGLEDALO Ø 25		povečevalno ogledalo, okroglo	3838987 546535	110,00
uvečavajuće ogledalo, okruglo					
TOD, TO 100 -LED, SW, S					
	TOD 100 BEIGE -LED, SW, S		toaletna omarica z LED svetilko, stikalo (SW), vtičnica (S)	3838987 510826	528,00
	TO 100 BL -LED, SW, S		toaletni ormarič s LED svjetlom, prekidač (SW), utičnica (S)	3838987 528876	528,00
1000 x 690 x 130		NEUTRAL WHITE			
TOD, TO 80 -LED, SW, S					
	TOD 80 BEIGE -LED, SW, S		toaletna omarica z LED svetilko, stikalo (SW), vtičnica (S)	3838987 528845	446,00
	TO 80 BL -LED, SW, S		toaletni ormarič s LED svjetlom, prekidač (SW), utičnica (S)	3838987 528869	446,00
800 x 690 x 130		NEUTRAL WHITE			
www.kolpa.si		www.kolpa.hr		237	

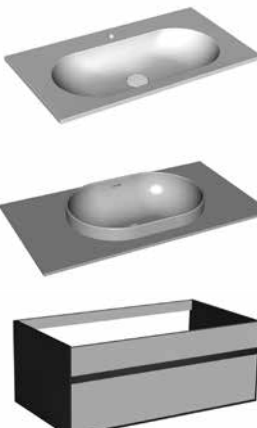
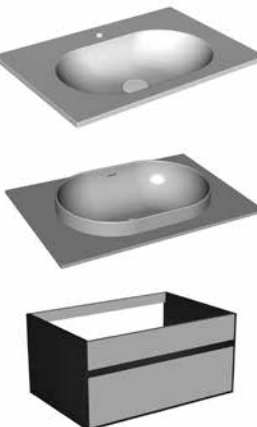
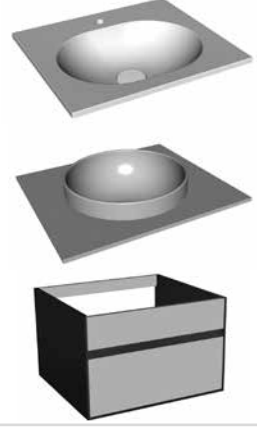

Model	Naziv in dimenzija izdelka Naziv i dimenzije produkta	Opis Opis	EAN koda EAN koda	Cena EUR Cijena EUR
TOD, TO 60 -LED, SW, S				
	TOD 60 BEIGE -LED, SW, S	toaletna omarica z LED svetilko, stikalo (SW), vtičnica (S) toaletni ormarič s LED svjetlom, prekidač (SW), utičnica (S) NEUTRAL WHITE	3838987 528838	352,00
	TO 60 BL -LED, SW, S		3838987 528852	352,00
600 x 690 x 130				
OULD 100				
	UD 100 /LM	umivalnik iz litega marmorja umivaonik od lijevanog mramora	3838987 528920	227,00
	UD 100 /KER	keramični umivalnik vgrajen na Kerrock odlagalni površini keramički umivaonik ugrađen na površini za odlaganje od Kerrocka	3838987 528951	274,00
	Ima izvrtino za armaturo/ ima otvor za armaturo			
OD 100 BEIGE / WH	podumivalniška omarica s predalom element ispod umivaonika s ladicom	3838987 510819	398,00	
OD 100 BL / WH		3838987 528821	398,00	
990 x 432 x 535				
OULD 80				
	UD 80 /LM	umivalnik iz litega marmorja umivaonik od lijevanog mramora	3838987 528913	205,00
	UD 80 /KER	keramični umivalnik vgrajen na Kerrock odlagalni površini keramički umivaonik ugrađen na površini za odlaganje od Kerrocka	3838987 528944	245,00
	Ima izvrtino za armaturo/ ima otvor za armaturo			
OD 80 BEIGE / WH	podumivalniška omarica s predalom element ispod umivaonika s ladicom	3838987 528791	360,00	
OD 80 BL / WH		3838987 528814	360,00	
790 x 432 x 535				
OULD 60				
	UD 60 /LM	umivalnik iz litega marmorja umivaonik od lijevanog mramora	3838987 528906	184,00
	UD 60 /KER	keramični umivalnik vgrajen na Kerrock odlagalni površini keramički umivaonik ugrađen na površini za odlaganje od Kerrocka	3838987 528937	215,00
OD 60 BEIGE / WH	podumivalniška omarica s predalom element ispod umivaonika s ladicom	3838987 528784	318,00	
OD 60 BL / WH		3838987 528807	318,00	
590 x 432 x 535				
238	www.kolpa.hr	www.kolpa.si		







Kopalniško pohištvo

Kupaonski namještaj

Program: DONNA

Umivalnik: a) liti marmor (LM) / b) keramični, vgrajen v Kerrock ploščo (KER); vrata - lakirani MDF, bela (WH); obod - lakirani MDF, črna (BL), BEIGE, umivaonik: a) lijevani marmor (LM) / b) keramični, ugraden u Kerrock plošču; vrata - lakirani MDF bijela (WH); obod - lakirani MDF, črna (BL), BEIGE

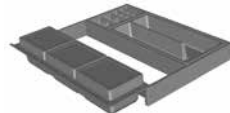
kolpa-san®

Model	Naziv in dimenzija izdelka Naziv i dimenzije produkta	Opis Opis	EAN koda EAN koda	Cena EUR Cijena EUR
D 671				
	D 671 BEIGE/WH	omara z vrati in predalom ormarič sa vratima i ladicom	3838987 510833	331,00
	D 671 BL/WH		3838987 528883	331,00
	460 x 680 x 325			
D 1453				
	D 1453 BEIGE/WH	omara z vrati ormarič sa vratima	3838987 510840	493,00
	D 1453 BL/WH		3838987 528890	493,00
	450 x 1450 x 321			
LUČ 700, 500 BL -LED				
	LUČ 700 BL -LED L=700	Svetilka (LED) za OG Svjetlo (LED) za OG NEUTRAL WHITE	3838987 547518	95,00
	LUČ 500 BL -LED L=500		3838987 546542	88,00
LUČ 300 -LED				
	LUČ 300 -LED L=300	svetilka (LED) brez vtičnice in stikala za OG svjetlo (LED) bez utičnice i prekidača za OG NEUTRAL WHITE	3838987 509974	53,00
ORGANIZATOR PREDALA				
	ORGANIZATOR PREDALA ZG.400	za zgornji predal za gornju ladicu	3838987 529460	45,00
NOGICE POHIŠTVA				
	NOGICE POHIŠTVA, h=40 cm	nogice za omarice, h=40 cm, (par) nogice za ormariče, h=40 cm, (par)	3838987 505921	62,00









Kopalniško pohištvo
 Kupaonski namještaj





Program: OXANA

Umivalnik: keramični, vrata: MDF oplaščen, PVC folija, barva: bela-mat (WH), svetla akacija (ACACIA LIGHT), temni hrast (HACIENDA BL.) umivaonik: keramički, vrata: MDF prevučeni, PVC folija, boja: bijela-mat (WH), svjetli bagrem (ACACIA LIGHT), tamni hrast (HACIENDA BL.)

kolpa-san®

Model	Naziv in dimenzija izdelka Naziv i dimenzije produkta	Opis Opis	EAN koda EAN koda	Cena EUR Cijena EUR
OG 120, OG 90 -LED, T, C				
	OG 120 -LED, T, C 1200 x 700 x 20	ogledalo z integrirano LED svetilko in uro (C), senzorsko stikalo (T) ogledalo sa integriranim LED svjetlom i satom (C), senzorski prekidač (T) NEUTRAL WHITE	3838987 507819	341,00
	OG 90 -LED, T, C 900 x 700 x 20		3838987 507802	289,00
OG 100, 80, 60 -LED, T				
	OG 100 -LED, T 1000 x 700 x 20	ogledalo z integrirano ambientalno LED svetilko, senzorsko stikalo (T) ogledalo s integriranim ambientalnim LED svjetlom, senzorski prekidač (T) NEUTRAL WHITE	3838987 507260	311,00
	OG 80 -LED, T 800 x 700 x 20		3838987 507253	275,00
	OG 60 -LED, T 600 x 700 x 20		3838987 507246	254,00
OG 100, 80, 60				
	OG 100 1000 x 700 x 20	ogledalo, pravokotno ogledalo, pravokutno	3838987 547402	94,00
	OG 80 800 x 700 x 20		3838987 546436	83,00
	OG 60 600 x 700 x 20		3838987 547389	72,00
POLICA OG 100, 80, 60				
 	POLICA OG 100 WH 1005 x 22 x 120	polica za pravokotno ogledalo s konzolo polica za pravokutnu ogledalo s konzolom	3838987 547464	58,00
	POLICA OG 80 WH 805 x 22 x 120		3838987 547440	51,00
	POLICA OG 60 WH 605 x 22 x 120		3838987 547426	45,00
KOZMETIČNO OGLEDALO				
	KOZMETIČNO OGLEDALO Ø 25	povečevalno ogledalo, okroglo uvečavajuće ogledalo, okruglo	3838987 546535	110,00



Model	Naziv in dimenzija izdelka Naziv i dimenzije produkta	Opis Opis	EAN koda EAN koda	Cena EUR Cijena EUR
T00 100 -LED, SW, S				
	T00 100 WH -LED, SW, S	toaletna omarica z LED svetilko, stikalo (SW), vtićnica (S) toaletni ormarić s LED svjetlom, prekidać (SW), utićnica (S) NEUTRAL WHITE	3838987 508281	387,00
	T00 100 ACACIA LIGHT -LED, SW, S		3838987 508298	387,00
	T00 100 HACIENDA BL. -LED, SW, S		3838987 508304	387,00
	1000 x 647 x 149			
T00 80 -LED, SW, S				
	T00 80 WH -LED, SW, S	toaletna omarica z LED svetilko, stikalo (SW), vtićnica (S) toaletni ormarić s LED svjetlom, prekidać (SW), utićnica (S) NEUTRAL WHITE	3838987 508250	349,00
	T00 80 ACACIA LIGHT -LED, SW, S		3838987 508267	349,00
	T00 80 HACIENDA BL. -LED, SW, S		3838987 508274	349,00
	800 x 647 x 149			
T00 60 -LED, SW, S				
	T00 60 WH -LED, SW, S	toaletna omarica z LED svetilko, stikalo (SW), vtićnica (S) toaletni ormarić s LED svjetlom, prekidać (SW), utićnica (S) NEUTRAL WHITE	3838987 508229	323,00
	T00 60 ACACIA LIGHT -LED, SW, S		3838987 508236	323,00
	T00 60 HACIENDA BL. -LED, SW, S		3838987 508243	323,00
	600 x 647 x 149			
OOU 105				
	OOU 105 WH	omarica z umivalnikom ormarić s umivaonikom	3838987 507215	612,00
	OOU 105 ACACIA LIGHT		3838987 507222	612,00
	OOU 105 HACIENDA BL.		3838987 507239	612,00
	1055 x 651 x 460			
OOU 80				
	OOU 80 WH	omarica z umivalnikom ormarić s umivaonikom	3838987 506577	498,00
	OOU 80 ACACIA LIGHT		3838987 507192	498,00
	OOU 80 HACIENDA BL.		3838987 507208	498,00
	800 x 651 x 460			







Kopalniško pohištvo

Kupaonski namještaj



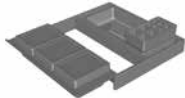
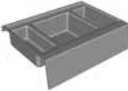

Program: OXANA

Umivalnik: keramični, vrata: MDF oplaščen, PVC folija, barva: bela-mat (WH), svetla akacija (ACACIA LIGHT), temni hrast (HACIENDA BL.) umivaonik: keramički, vrata: MDF prevučeni, PVC folija, boja: bijela-mat (WH), svjetli bagrem (ACACIA LIGHT), tamni hrast (HACIENDA BL.)



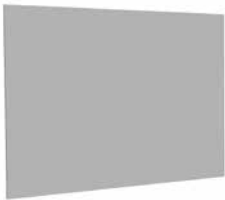





kolpa-san®

Model	Naziv in dimenzija izdelka Naziv i dimenzije produkta	Opis Opis	EAN koda EAN koda	Cena EUR Cijena EUR
OUO 60				
	OUO 60 WH	omarica z umivalnikom ormarič s umivaonikom	3838987 507161	433,00
	OUO 60 ACACIA LIGHT		3838987 507178	433,00
	OUO 60 HACIENDA BL.		3838987 507185	433,00
	605 x 651 x 460			
O 1752				
	O 1752 WH	omarica z vrati ormarič sa vratima	3838987 506584	262,00
	O 1752 ACACIA LIGHT		3838987 507307	262,00
	O 1752 HACIENDA BL.		3838987 507314	262,00
	400 x 1753 x 322			
O 953				
	O 953 WH	omarica z vrati ormarič sa vratima	3838987 507321	234,00
	O 953 ACACIA LIGHT		3838987 507338	234,00
	O 953 HACIENDA BL.		3838987 507345	234,00
	406 x 954 x 325			
LUČ 700, 500 BL -LED				
	LUČ 700 BL -LED	Svetilka (LED) za OG Svjetlo (LED) za OG NEUTRAL WHITE	3838987 547518	95,00
	LUČ 500 BL -LED		3838987 546542	88,00
LUČ 300 -LED				
	LUČ 300 -LED	svetilka (LED) brez vtičnice in stikala za OG svjetlo (LED) bez utičnice i prekidača za OG NEUTRAL WHITE	3838987 509974	53,00
	L = 300			
ORGANIZATOR PREDALA				
	ORGANIZATOR PREDALA ZG.350	za zgornji predal za gornju ladicu	3838987 529477	40,00
	ORGANIZATOR PREDALA SP.350	za spodnji predal za donju ladicu	3838987 529491	43,00
	KOZMETIČNI KOŠ	za spodnji predal za donju ladicu	3838987 529507	20,00
	174 x 232 x 174			
NOGICE POHIŠTVA				
	NOGICE POHIŠTVA, h=20 cm	nogice za omarice, h=20 cm, (par) noge za ormariče, h=20 cm, (par)	3838987 505914	39,00
	www.kolpa.si	www.kolpa.hr		243



Model	Naziv in dimenzija izdelka Naziv i dimenzije produkta	Opis Opis	EAN koda EAN koda	Cena EUR Cijena EUR
OG 60 -LED, T				
	OG 60 -LED, T 600 x 700 x 20	ogledalo z integrirano ambientalno LED svetilko, senzorsko stikalo (T) ogledalo s integriranim ambientalnim LED svetlom, senzorski prekidač (T) NEUTRAL WHITE	3838987 507246	254,00
OG 60, 50				
	OG 60 600 x 700 x 20	ogledalo, pravokotno	3838987 547389	72,00
	OG 50 500 x 700 x 20	ogledalo, pravokutno	3838987 546405	59,00
POLICA OG 60, 50				
 	POLICA OG 60 WH 605 x 22 x 120	polica za pravokotno ogledalo s konzolo	3838987 547426	45,00
	POLICA OG 50 WH 505 x 22 x 120	polica za pravokutnu ogledalo s konzolom	3838987 546467	42,00
KOZMETIČNO OGLEDALO				
	KOZMETIČNO OGLEDALO Ø 25	povečevalno ogledalo, okroglo uvečavajuće ogledalo, okruglo	3838987 546535	110,00
OGK 40				
	OGK 40/90 WH	ogledalo	3838987 503101	69,00
	OGK 40/90 CW	ogledalo	3838987 547587	69,00
	400 x 900 x 21			



Model	Naziv in dimenzija izdelka Naziv i dimenzije produkta	Opis Opis	EAN koda EAN koda	Cena EUR Cijena EUR		
OUK 40, 50, 60						
	OUK 40 WH	406 x 510 x 253	omarica z umivalnikom ormarič s umivaonikom	3838987 502821	207,00	
	OUK 40 CW			3838987 547594	207,00	
	OUK 50 WH			506 x 510 x 253	3838987 538783	227,00
	OUK 50 CW				3838987 547624	227,00
	OUK 60 WH	606 x 510 x 303		3838987 538806	255,00	
	OUK 60 CW			3838987 547655	255,00	
	OUK 40 -L WH	406 x 510 x 253	omarica z umivalnikom ormarič s umivaonikom	3838987 529125	210,00	
	OUK 40 -L CW			3838987 547600	210,00	
	OUK 50 -L WH	506 x 510 x 253	- leva izvedba - lijeva varijanta	3838987 568087	231,00	
	OUK 50 -L CW			3838987 547631	231,00	
	OUK 60 -L WH	606 x 510 x 303		3838987 561217	253,00	
	OUK 60 -L CW			3838987 547662	253,00	
	OUK 40 -D WH	406 x 510 x 253	omarica z umivalnikom ormarič s umivaonikom	3838987 529132	210,00	
	OUK 40 -D CW			3838987 547617	210,00	
	OUK 50 -D WH	506 x 510 x 253	- desna izvedba - desna varijanta	3838987 561156	231,00	
	OUK 50 -D CW			3838987 547648	231,00	
	OUK 60 -D WH	606 x 510 x 303		3838987 561194	253,00	
	OUK 60 -D CW			3838987 547679	253,00	
LUČ 300 -LED						
 	LUČ 300 -LED	L = 300	svetilka (LED) brez vtičnice in stikala svjetlo (LED) bez utičnice i prekidača NEUTRAL WHITE	3838987 509974	53,00	
LUČ 500 BL -LED						
 	LUČ 500 BL -LED	L = 500	Svetilka (LED) za OGE in TOE Svjetlo (LED) za OGE i TOE NEUTRAL WHITE	3838987 546542	88,00	



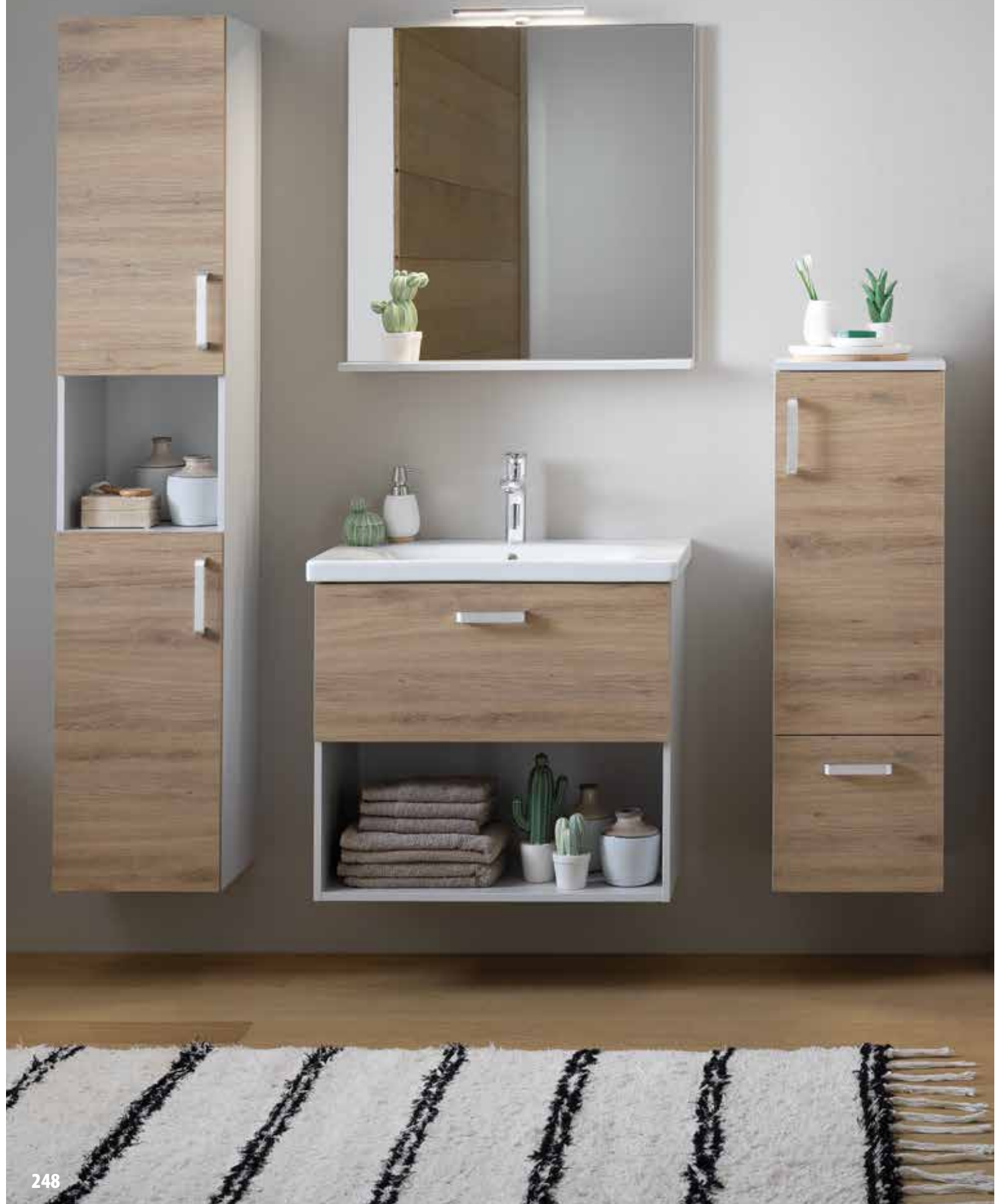





Kopalniško pohištvo
Kupaonski namještaj

Program: EVELIN

Umivalnik: keramični, vrata: oplemenitena iverna plošča, barva: bela sijaj (WH), antracit (ANT), hrast (OAK) / umivaonik: keramički, vrata: oplemenitena iverna ploča, boja: bijela sjaj (WH), antracit (ANT), hrast (OAK)

kolpa-san

Model	Naziv in dimenzija izdelka Naziv i dimenzije produkta	Opis Opis	EAN koda EAN koda	Cena EUR Cijena EUR
OGE 55, 65, 80				
	OGE 55 WH	ogledalo s polico	3838987 561989	69,00
	OGE 55 GRAY 550 x 700 x 140	ogledalo sa policom	3838987 561996	69,00
	OGE 65 WH	ogledalo s polico	3838987 573920	73,00
	OGE 65 GRAY 650 x 700 x 140	ogledalo sa policom	3838987 573937	73,00
	OGE 80 WH	ogledalo s polico	3838987 573944	79,00
	OGE 80 GRAY 800 x 700 x 140	ogledalo sa policom	3838987 573951	79,00
TOE 55, 65, 80				
	TOE 55 WH	toaletna omarica	3838987 562009	100,00
	TOE 55 GRAY 550 x 700 x 140	toaletni ormarič	3838987 562016	100,00
	TOE 65 WH	toaletna omarica	3838987 573968	105,00
	TOE 65 GRAY 650 x 700 x 140	toaletni ormarič	3838987 573975	105,00
	TOE 80 WH	toaletna omarica	3838987 573982	118,00
	TOE 80 GRAY 800 x 700 x 140	toaletni ormarič	3838987 573999	118,00
OUE 55, 65, 80				
	OUE 55 WH	omarica z umivalnikom	3838987 562023	193,00
	OUE 55 GRAY/ANT	ormarič s umivaonikom	3838987 562030	193,00
	OUE 55 GRAY/OAK 555 x 645 x 460		3838987 562047	193,00
	OUE 65 WH	omarica z umivalnikom	3838987 573807	215,00
	OUE 65 GRAY/ANT	ormarič s umivaonikom	3838987 573814	215,00
	OUE 65 GRAY/OAK 655 x 645 x 460		3838987 573821	215,00
	OUE 80 WH	omarica z umivalnikom	3838987 573838	238,00
	OUE 80 GRAY/ANT	ormarič s umivaonikom	3838987 573845	238,00
	OUE 80 GRAY/OAK 800 x 645 x 460		3838987 573852	238,00
OUE 55 II, 65 II, 80 II				
	OUE 55 II WH	omarica z umivalnikom	3838987 562054	198,00
	OUE 55 II GRAY/ANT	ormarič s umivaonikom	3838987 562061	198,00
	OUE 55 II GRAY/OAK 555 x 645 x 460		3838987 562078	198,00
	OUE 65 II WH	omarica z umivalnikom	3838987 573869	218,00
	OUE 65 II GRAY/ANT	ormarič s umivaonikom	3838987 573876	218,00
	OUE 65 II GRAY/OAK 655 x 645 x 460		3838987 573883	218,00
	OUE 80 II WH	omarica z umivalnikom	3838987 573890	242,00
	OUE 80 II GRAY/ANT	ormarič s umivaonikom	3838987 573906	242,00
	OUE 80 II GRAY/OAK 800 x 645 x 460		3838987 573913	242,00



Kopalniško pohištvo
Kupaonski namještaj

Program: EVELIN

Umivalnik: keramični, vrata: oplemenitena iverna plošča, barva: bela sijaj (WH), antracit (ANT), hrast (OAK) / umivaonik: keramički, vrata: oplemenitena iverna ploča, boja: bijela sjaj (WH), antracit (ANT), hrast (OAK)



kolpa-san

Model	Naziv in dimenzija izdelka Naziv i dimenzije produkta	Opis Opis	EAN koda EAN koda	Cena EUR Cijena EUR
E 702 WH				
 	E 702 WH	omariča z vrati	3838987 574033	85,00
	E 702 GRAY/ANT	ormarič sa vratima	3838987 574040	85,00
	E 702 GRAY/OAK		3838987 574057	85,00
	370 x 700 x 346			
E 1021				
 	E 1021 WH	omariča z vrati in predalom	3838987 574002	145,00
	E 1021 GRAY/ANT	ormarič sa vratima i ladicom	3838987 574019	145,00
	E 1021 GRAY/OAK		3838987 574026	145,00
	372 x 1020 x 353			
E 1702				
 	E 1702 WH	omariča z vrati	3838987 574064	144,00
	E 1702 GRAY/ANT	ormarič sa vratima	3838987 574071	144,00
	E 1702 GRAY/OAK		3838987 574088	144,00
	370 x 1700 x 346			
LUČ 700, 500 BL BOX -LED, SW, S				
 	LUČ 700 BL BOX -LED, SW, S L=700	Svetilka (LED), stikalo (SW), vtičnica (S), BOX za TOE / Svjetlo (LED), prekidač (SW), utičnica (S), BOX za TOE	3838987 546566	129,00
	LUČ 500 BL BOX -LED, SW, S L=500		3838987 546559	122,00
		NEUTRAL WHITE		
LUČ 700, 500 BL -LED				
 	LUČ 700 BL -LED	Svetilka (LED) za OGE in TOE	3838987 547518	95,00
	LUČ 500 BL -LED	Svjetlo (LED) za OGE i TOE	3838987 546542	88,00
		NEUTRAL WHITE		

Kopalniško pohištvo
Kupaonski namještaj**Program: EVELIN**

Umivalnik: keramični, vrata: oplemenitena iverna plošča, barva: bela sijaj (WH), antracit (ANT), hrast (OAK) / umivaonik: keramički, vrata: oplemenitena iverna plošča, boja: bijela sijaj (WH), antracit (ANT), hrast (OAK)

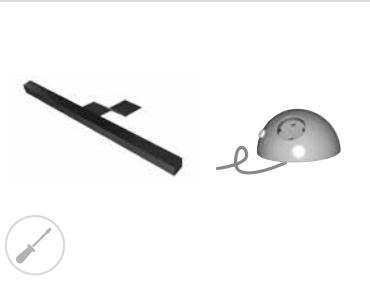
kolpa-san®

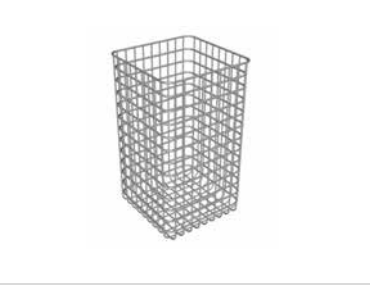
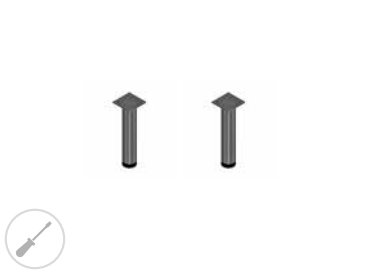
Model	Naziv in dimenzija izdelka Naziv i dimenzije produkta	Opis Opis	EAN koda EAN koda	Cena EUR Cijena EUR
LUČ 500 BOX -LED, SW, S				
	LUČ 500 BOX -LED, SW, S L = 500	svetilka (LED), stikalo (SW), vtičnica (S), BOX za toaletno omarico TOE /svjetlo (LED), prekidač (SW), utičnica (S), BOX za toaletni ormarič TOE NEUTRAL WHITE	3838987 300298	116,00
LUČ 300 -LED				
	LUČ 300 -LED L = 300	svetilka (LED) brez vtičnice in stikala za TOE in OGE svjetlo (LED) bez utičnice i prekidača za TOE i OGE NEUTRAL WHITE	3838987 509974	53,00
KOZMETIČNO OGLEDALO				
	KOZMETIČNO OGLEDALO Ø 25	povečevalno ogledalo, okroglo uvečavajuće ogledalo, okruglo	3838987 546535	110,00
KOŠ ZA PERILO				
	KOŠ ZA PERILO 280 x 500 x 218	koš za perilo za omarice širine 35 cm koš za rublje za ormarič širine 35 cm	3838987 944270	35,00
NOGICE POHIŠTVA				
	NOGICE POHIŠTVA, h=20 cm	nogice za omarice, h=20 cm, (par) noge za ormariče, h=20 cm, (par)	3838987 505914	39,00











Kopalniško pohištvo

Kupaonski namještaj

Program: LANA

Umivalnik: keramični, vrata, obod: oplemenitena iverna plošča, barva: siva (GRAY), svetla akacija (ACACIA LIGHT) umivaonik: keramični, vrata, obod: oplemenitena iverna ploča, boja: siva (GRAY), svjetli bagrem (ACACIA LIGHT)

kolpa-san®

Model	Naziv in dimenzija izdelka Naziv i dimenzije produkta	Opis Opis	EAN koda EAN koda	Cena EUR Cijena EUR
OGL 65, 80				
	OGL 65 GRAY	ogledalo s polico ogledalo sa policom	3838987 510864	77,00
	OGL 65 ACACIA LIGHT		3838987 529033	77,00
	650 x 700 x 140			
	OGL 80 GRAY	ogledalo s polico ogledalo sa policom	3838987 529026	86,00
OGL 80 ACACIA LIGHT	3838987 529040		86,00	
800 x 700 x 140				
TOL 65, 80				
	TOL 65 GRAY	toaletna omarica toaletni ormarič	3838987 529057	150,00
	TOL 65 ACACIA LIGHT		3838987 529071	150,00
	650 x 700 x 140			
	TOL 80 GRAY	toaletna omarica toaletni ormarič	3838987 529064	166,00
TOL 80 ACACIA LIGHT	3838987 510901		166,00	
800 x 700 x 140				
OUL 65, 80				
	OUL 65 GRAY	omarica z umivalnikom - vrata ormarič s umivaonikom - vrata	3838987 528999	239,00
	OUL 65 ACACIA LIGHT		3838987 529019	239,00
	650 x 570 x 495			
	OUL 80 GRAY	omarica z umivalnikom - vrata ormarič s umivaonikom - vrata	3838987 529002	271,00
OUL 80 ACACIA LIGHT	3838987 510895		271,00	
800 x 570 x 495				
OUL 65 II, 80 II				
	OUL 65 II GRAY	omarica z umivalnikom - predali ormarič s umivaonikom - ladice	3838987 510857	315,00
	OUL 65 II ACACIA LIGHT		3838987 528975	315,00
	650 x 570 x 495			
	OUL 80 II GRAY	omarica z umivalnikom - predali ormarič s umivaonikom - ladice	3838987 528968	353,00
OUL 80 II ACACIA LIGHT	3838987 528982		353,00	
800 x 570 x 495				
L 702/14				
	L 702/14 GRAY	omarica z vratni ormarič sa vratima	3838987 529095	83,00
	L 702/14 ACACIA LIGHT		3838987 510925	83,00
	400 x 700 x 136			





Kopalniško pohištvo Kupaonski namještaj		Program: LANA			Umivalnik: keramični, vrata, obod: oplemenitena iverna plošča, barva: siva (GRAY), svetla akacija (ACACIA LIGHT) umivaonik: keramički, vrata, obod: oplemenitena iverna ploča, boja: siva (GRAY), svjetli bagrem (ACACIA LIGHT)		kolpa-san®		
Model	Naziv in dimenzija izdelka Naziv i dimenzije produkta	Opis Opis	EAN koda EAN koda	Cena EUR Cijena EUR					
L 872									
 	L 872 GRAY	omariča z vrati ormarič sa vratima	3838987 510888	131,00					
	L 872 ACACIA LIGHT		3838987 529088	131,00					
402 x 876 x 370									
L 1562									
 	L 1562 GRAY	omariča z vrati ormarič sa vratima	3838987 510871	204,00					
	L 1562 ACACIA LIGHT		3838987 510918	204,00					
400 x 1560 x 366									
LUČ 700, 500 BL BOX-LED, SW, S									
 	LUČ 700 BL BOX-LED, SW, S	L=700	Svetilka (LED), stikalo (SW), vtičnica (S), BOX za TOL	3838987 546566	129,00				
	LUČ 500 BL BOX-LED, SW, S	L=500	/ Svetlo (LED), prekidač (SW), utičnica (S), BOX za TOL	3838987 546559	122,00				
NEUTRAL WHITE									
LUČ 700, 500 BL-LED									
 	LUČ 700 BL-LED	L=700	Svetilka (LED) za TOL in OGL	3838987 547518	95,00				
	LUČ 500 BL-LED	L=500	Svetlo (LED) za TOL i OGL	3838987 546542	88,00				
NEUTRAL WHITE									
LUČ 500 BOX-LED, SW, S									
 	LUČ 500 BOX-LED, SW, S	L=500	svetilka (LED), stikalo (SW), vtičnica (S), BOX za toaletno omaričo TOL / svetlo (LED), prekidač (SW), utičnica (S), BOX za toaletni ormarič TOL	3838987 300298	116,00				
NEUTRAL WHITE									





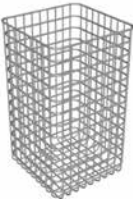

Kopalniško pohištvo
Kupaonski namještaj**Program: LANA**

Umivalnik: keramični, vrata, obod: oplemenitena iverna plošča, barva: siva (GRAY), svetla akacija (ACACIA LIGHT) umivaonik: keramični, vrata, obod: oplemenitena iverna ploča, boja: siva (GRAY), svjetli bagrem (ACACIA LIGHT)

kolpa-san®

Model	Naziv in dimenzija izdelka Naziv i dimenzije produkta	Opis Opis	EAN koda EAN koda	Cena EUR Cijena EUR
LUČ 300 -LED				
 	LUČ 300 -LED L = 300	svetilka (LED) brez vtičnice in stikala za TOL in OGL svjetlo (LED) bez utičnice i prekidača za TOL i OGL NEUTRAL WHITE	3838987 509974	53,00
KOZMETIČNO OGLEDALO				
	KOZMETIČNO OGLEDALO Ø 25	povečevalno ogledalo, okroglo uvećavajuće ogledalo, okruglo	3838987 546535	110,00
KOŠ ZA PERILO				
	KOŠ ZA PERILO 280 x 500 x 218	koš za perilo za omariče širine 35 cm koš za rublje za ormarič širine 35 cm	3838987 944270	35,00

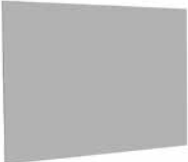
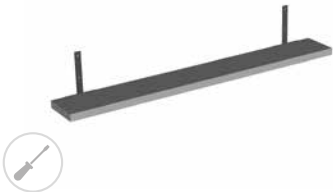

Model	Naziv in dimenzija izdelka Naziv i dimenzije produkta	Opis Opis	EAN koda EAN koda	Cena EUR Cijena EUR
OG Ø 150 -LED, IR, DIM				
	OG Ø 150 (Ø 120 + Ø 80) -LED, IR, DIM (2 ogledala /ogledala, 3 lučke/svjetla) 1500 x 1200 x 30	ogledalo z LED svetilko, senzorsko stikalo (IR), regulator intenzivnosti svetlobe (DIM) / ogledalo sa LED svjetlom, senzorski prekidač (IR), regulator intenzivnosti svjetla (DIM) NEUTRAL WHITE	3838987 546450	510,00
OG Ø 120, 100, 80 -LED, IR, DIM				
	OG Ø 120 -LED, IR, DIM (2 lučki/svjetla) OG Ø 100 -LED, IR, DIM OG Ø 80 -LED, IR, DIM	ogledalo z LED svetilko, senzorsko stikalo (IR), regulator intenzivnosti svetlobe (DIM) / ogledalo sa LED svjetlom, senzorski prekidač (IR), regulator intenzivnosti svjetla (DIM) NEUTRAL WHITE	3838987 573708 3838987 573692 3838987 573685	380,00 285,00 253,00
OG 100, 80, 60 -LED, T				
	OG 100 -LED, T 1000 x 700 x 20 OG 80 -LED, T 800 x 700 x 20 OG 60 -LED, T 600 x 700 x 20	ogledalo z integrirano ambientalno LED svetilko, senzorsko stikalo (T) / ogledalo s integriranim ambientalnim LED svjetlom, senzorski prekidač (T) NEUTRAL WHITE	3838987 507260 3838987 507253 3838987 507246	311,00 275,00 254,00
OG 120, OG 90 -LED, T, C				
	OG 120 -LED, T, C 1200 x 700 x 20 OG 90 -LED, T, C 900 x 700 x 20	ogledalo z integrirano LED svetilko in uro (C), senzorsko stikalo (T) / ogledalo sa integriranim LED svjetlom i satom (C), senzorski prekidač (T) NEUTRAL WHITE	3838987 507819 3838987 507802	341,00 289,00
OG 150, 120, 100, 90, 80, 70, 60, 50				
	OG 150 1500 x 700 x 20 OG 120 1200 x 700 x 20 OG 100 1000 x 700 x 20 OG 90 900 x 700 x 20 OG 80 800 x 700 x 20 OG 70 700 x 700 x 20 OG 60 600 x 700 x 20 OG 50 500 x 700 x 20	ogledalo, pravokotno ogledalo, pravokotno	3838987 547419 3838987 546443 3838987 547402 3838987 547396 3838987 546436 3838987 546412 3838987 547389 3838987 546405	123,00 108,00 94,00 88,00 83,00 76,00 72,00 59,00
POLICA OG 150, 120, 100, 90, 80, 70, 60, 50				
	POLICA OG 150 WH 1505 x 22 x 120 POLICA OG 120 WH 1205 x 22 x 120 POLICA OG 100 WH 1005 x 22 x 120 POLICA OG 90 WH 905 x 22 x 120 POLICA OG 80 WH 805 x 22 x 120 POLICA OG 70 WH 705 x 22 x 120 POLICA OG 60 WH 605 x 22 x 120 POLICA OG 50 WH 505 x 22 x 120	polica za pravokotno ogledalo s konzolo polica za pravokutnu ogledalo s konzolom	3838987 547471 3838987 546474 3838987 547464 3838987 547457 3838987 547440 3838987 547433 3838987 547426 3838987 546467	72,00 65,00 58,00 55,00 51,00 47,00 45,00 42,00
KOZMETIČNO OGLEDALO				
	KOZMETIČNO OGLEDALO Ø 25	povečevalno ogledalo, okroglo uvečavajuće ogledalo, okruglo	3838987 546535	110,00
256	www.kolpa.hr	www.kolpa.si		



Kopalniški dodatki Kupaonski dodaci





Pridržujemo si pravico do spremembe podatkov. Dimenzije so informativnega značaja.
Pridržavamo si pravo do promjena podataka. Dimenzije su informativnog karaktera.



Slike so simbolične.
Slike su simbolične.

2

leti garancije
godina jamstva







Model	Naziv in dimenzija izdelka Naziv i dimenzije produkta	Opis Opis	EAN koda EAN koda	Cena EUR Cijena EUR
AR01				
	AR01 Dimenzija: 20 x 40 x 40	kljukasto obešalo (1 kljukica) kukasta vješalica	3838987 488002	13,00
AR02				
	AR02 Dimenzija: 60 x 20 x 40	kljukasto obešalo (2 kljukici) kukasta vješalica (2 kukice)	3838987 488019	24,00
AR03				
	AR03 Dimenzija: 30 x 110 x 110	nosilec s kozarcem držač s čašom	3838987 488026	42,00
AR04				
	AR04 Dimenzija: 30 x 110 x 110	nosilec s podstavkom za milo držač posudice za sapun	3838987 488033	42,00
AR05				
	AR05 Dimenzija: 200 x 30 x 80	obešalo za brisače – 200 držač ručnika	3838987 488040	56,00





Model	Naziv in dimenzija izdelka Naziv i dimenzije produkta	Opis Opis	EAN koda EAN koda	Cena EUR Cijena EUR
AR06				
	AR06 Dimenzija: 450 x 30 x 80	obešalo za brisače – 450 držač ručnika	3838987 488057	83,00
AR07				
	AR07 Dimenzija: 600 x 30 x 135	obešalo za brisače, dvojno – 600 držač ručnika, dvostruki	3838987 488064	124,00
AR08				
	AR08 Dimenzija: 602 x 130 x 200	polica z obešalom za brisače polica sa držačem ručnika	3838987 488071	193,00
AR09				
	AR09 Dimenzija: 140 x 30 x 80	nosilec toaletnega papirja držač toaletnog papira	3838987 488088	42,00
AR10				
	AR10 Dimenzija: 110 x 30 x 110	wc garnitura (posodica + ščetka) wc garnitura (posudica + četkica)	3838987 488095	58,00







Model	Naziv in dimenzija izdelka Naziv i dimenzije produkta	Opis Opis	EAN koda EAN koda	Cena EUR Cijena EUR
MI01				
	MI01 Dimenzija: 72 x 30 x 52	kjukasto obešalo (2 kljukici), black kukasta vješalica (2 kukice), black	3838987 488736	22,00
MI02				
	MI02 Dimenzija: 70 x 30 x 106	nosilec s kozarcem, black držač s čašom, black	3838987 488743	30,00
MI03				
	MI03 Dimenzija: 70 x 30 x 106	nosilec s podstavkom za milo, black držač s čašom, black	3838987 488750	30,00
MI04				
	MI04 Dimenzija: 70 x 30 x 106	nosilec za tekoče milo, black držač tekučeg sapuna, black	3838987 488767	31,00
MI06				
	MI06 Dimenzija: 250 x 30 x 80	obešalo za brisače – 250, black držač ručnika, black	3838987 488781	35,00





Kopalniška galanterija Kupaonska galanterija	Program: MINOS Black		Kopalniška galanterija Kupaonska galanterija	kolpa-san
Model	Naziv in dimenzija izdelka Naziv i dimenzije produkta	Opis Opis	EAN koda EAN koda	Cena EUR Cijena EUR
MI07				
	MI07 Dimenzija: 450 x 30 x 80	obešalo za brisače – 450, black držač ručnika, black	3838987 488798	39,00
MI08				
	MI08 Dimenzija: 600 x 30 x 130	obešalo za brisače, dvojno – 600, black držač ručnika, dvostruki, black	3838987 488804	60,00
MI09				
	MI09 Dimenzija: 140 x 30 x 80	nosilec toaletnega papirja, black držač toaletnog papira, black	3838987 488811	33,00
MI10				
	MI10 Dimenzija: 137 x 123 x 56	nosilec toaletnega papirja s pokrovom, black držač toaletnog papira sa pokrovom, black	3838987 488828	35,00
MI11				
	MI11 Dimenzija: 70 x 30 x 106	wc garnitura (posudica + ščetka), black wc garnitura (posudica + četkica), black	3838987 488835	51,00







Model	Naziv in dimenzija izdelka Naziv i dimenzije produkta	Opis Opis	EAN koda EAN koda	Cena EUR Cijena EUR
MI01				
	MI01 Dimenzija: 72 x 30 x 52	kljukasto obešalo (2 kljukici) kukasta vješalica (2 kukice)	3838987 488101	19,00
MI02				
	MI02 Dimenzija: 70 x 30 x 106	nosilec s kozarcem držač s čašom	3838987 488118	25,00
MI03				
	MI03 Dimenzija: 70 x 30 x 106	nosilec s podstavkom za milo držač s čašom	3838987 488125	25,00
MI04				
	MI04 Dimenzija: 70 x 30 x 106	nosilec za tekoče milo držač tekućeg sapuna	3838987 488132	26,00
MI06				
	MI06 Dimenzija: 250 x 30 x 80	obešalo za brisače – 250 držač ručnika	3838987 488156	31,00





Model	Naziv in dimenzija izdelka Naziv i dimenzije produkta	Opis Opis	EAN koda EAN koda	Cena EUR Cijena EUR
MI07				
	MI07 Dimenzija: 450 x 30 x 80	obešalo za brisače – 450 držač ručnika	3838987 488163	33,00
MI08				
	MI08 Dimenzija: 600 x 30 x 130	obešalo za brisače, dvojno – 600 držač ručnika, dvostruki	3838987 488170	50,00
MI09				
	MI09 Dimenzija: 140 x 30 x 80	nosilec toaletnega papirja držač toaletnog papira	3838987 488187	28,00
MI10				
	MI10 Dimenzija: 137 x 123 x 56	nosilec toaletnega papirja s pokrovom držač toaletnog papira sa pokrovom	3838987 488194	31,00
MI11				
	MI11 Dimenzija: 70 x 30 x 106	wc garnitura (posodica + ščetka) wc garnitura (posudica + četkica)	3838987 488200	45,00







Kopalniška galanterija Kupaonska galanterija	Program: TALOS		Kromirana kopalniška galanterija Kromirana kupaonska galanterija	kolpa-san
Model	Naziv in dimenzija izdelka Naziv i dimenzije produkta	Opis Opis	EAN koda EAN koda	Cena EUR Cijena EUR
TA01				
	TA01 Dimenzija: 55 x 57,5 x 63	kljukasto obešalo (1 kljukica) kukasta vješalica	3838987 488217	14,00
TA02				
	TA02 Dimenzija: 53 x 80 x 63	kljukasto obešalo (2 kljukici) kukasta vješalica (2 kukice)	3838987 488224	19,00
TA03				
	TA03 Dimenzija: 133 x 55 x 120	nosilec s kozarcem držač s čašom	3838987 488231	22,00
TA04				
	TA04 Dimenzija: 133 x 55 x 120	nosilec s podstavkom za milo držač posude za sapun	3838987 488248	22,00
TA06				
	TA06 Dimenzija: 238 x 55 x 73	obešalo za brisače – 238 držač ručnika	3838987 488262	24,00

Model	Naziv in dimenzija izdelka Naziv i dimenzije produkta	Opis Opis	EAN koda EAN koda	Cena EUR Cijena EUR
TA07				
	TA07 Dimenzija: 450 x 55 x 82,5	obešalo za brisače – 450 držač ručnika	3838987 488279	26,00
TA08				
	TA08 Dimenzija: 600 x 55 x 123	obešalo za brisače, dvojno – 600 držač ručnika, dvostruki	3838987 488286	37,00
TA09				
	TA09 Dimenzija: 178 x 55 x 73	nosilec toaletnega papirja držač toaletnog papira	3838987 488293	22,00
TA10				
	TA10 Dimenzija: 150 x 144 x 73,5	nosilec toaletnega papirja s pokrovom držač toaletnog papira sa pokrovom	3838987 488309	27,00
TA11				
	TA11 Dimenzija: 160 x 55 x 120	wc garnitura (posodica + ščetka) wc garnitura (posudica + četkica)	3838987 488316	34,00







Model	Naziv in dimenzija izdelka Naziv i dimenzije produkta	Opis Opis	EAN koda EAN koda	Cena EUR Cijena EUR
EL3303				
	EL3303 Dimenzija: 240 x 28	kljukasto obešalo-3 kljukice kukasta vješalica-3 kuke	3838987 488323	19,00
EL3304				
	EL3304 Dimenzija: 315 x 28	kljukasto obešalo-4 kljukice kukasta vješalica-4 kuke	3838987 488330	25,00
EL3305				
	EL3305 Dimenzija: 390 x 28	kljukasto obešalo-5 kljukic kukasta vješalica-5 kuka	3838987 488347	31,00
EL9600				
	EL9600 Dimenzija: 610 x 140 x 220	polica z obešalom za brisače, s 4 kljukicami, zložljivo držač ručnika sa 4 kuke, sklopivi	3838987 488361	103,00

Model	Naziv in dimenzija izdelka Naziv i dimenzije produkta	Opis Opis	EAN koda EAN koda	Cena EUR Cijena EUR
EL-SHOWER				
	EL-SHOWER Dimenzija: 235 x 135 x 730	dvojna viseča odlagalna košarica za tuš kabino / Dvostruka viseća košarica za tuš kabinu	3838987 491101	98,00
EL5710				
	EL5710 Dimenzija: 257 x 412 x 197	kotna odlagalna košarica za tuš kabino (dvojna) kutna košarica za tuš kabinu (dvostruka)	3838987 488354	82,00
EL6050				
	EL6050 Dimenzija: 252 x 136 x 123	stenska odlagalna košarica za tuš kabino zidna košarica za tuš kabinu	3838987 489405	34,00
EL5708				
	EL5708 Dimenzija: 285 x 220 x 110	kotna odlagalna košarica za tuš kabino kutna košarica za tuš kabinu	3838987 489412	33,00

Kopalniška galanterija
Kupaonska galanterija**Program: Ostalo**Kromirana kopalniška galanterija
Kromirana kupaonska galanterija



kolpa-san®

Model	Naziv in dimenzija izdelka Naziv i dimenzije produkta	Opis Opis	EAN koda EAN koda	Cena EUR Cijena EUR
EL5714, EL5715				
	EL5714 Dimenzija: 350 x 80 x 50	oprijem - 35 cm rukohvat - 35 cm	3838987 489382	32,00
	EL5715 Dimenzija: 450 x 80 x 50	oprijem - 45 cm rukohvat - 45 cm	3838987 496434	33,00
EL5716				
	EL5716 Dimenzija: 463 x 260 x 130	Kotni oprijem – 53 ° Kutni rukohvat – 53 °	3838987 494058	39,00
EL9700				
	EL9700 Dimenzija: 386 x 101	wc garnitura (posodica + ščetka) wc garnitura (posudica + četka)	3838987 490616	90,00
BRISALEC STEKLA				
	Brisalec stekla Brisač stakla	Brisalec stekla z držalom krom Brisač stakla sa kromiranom ručkom	3838987 491095	24,00

Kopalniška galanterija Kupaonska galanterija	Program: Kopalniški sedeži		Kopalniški sedeži Kupaonska sjedala	kolpa-san
Model	Naziv in dimenzija izdelka Naziv i dimenzije produkta	Opis Opis	EAN koda EAN koda	Cena EUR Cijena EUR
KS				
	KS	kopalniški stolček, h=38 cm, prenosni kupaonska stolica, h=38 cm, prijenosni	3838987 950608	56,00
SKK				
	SKK	sedež za kopalno kad sjedalo za kupaonsku kadu BETTY 170, 160, 150, 140, 130, 120, EVELIN 140, 150, 160, 170, ELEKTRA 160, 170, FIGARO 150, 170, MINI 100, TAMIA 170, 160, 150, 140 (Nosilnost do 130 kg)	3838987 950943	101,00
SDL				
	SDL	sedež za tuš kabino - višinsko nastavljiv sjedalo za tuš kabino - podesiv po visini (Nosilnost do 110 kg)	3838987 593935	235,00
STK-N				
	STK-N	sedež za tuš kabino z nogicama - preklopni sjedalo za tuš kabino sa nožicama - preklopni (Nosilnost do 110 kg)	3838987 573227	174,00
STK				
	STK	sedež za tuš kabino - preklopni sjedalo za tuš kabino - preklopni (Nosilnost do 110 kg)	3838987 950707	151,00

Kopalniški dodatki
 Kupaonski dodaci



Kopalniška galanterija Kupaonska galanterija	Program: Vzglavniki		Vzglavniki za kopalne kadi Nasloni za glavu za kupaonske kade	kolpa-san®
Model	Naziv in dimenzija izdelka Naziv i dimenzije produkta	Opis Opis	EAN koda EAN koda	Cena EUR Cijena EUR
HEADREST SOFT				
	HEADREST SOFT	vzglavnik za kopalno kad naslon za glavu, za kade BETTY, DOLORES, LIBRETTO, GAIA, DIVANTE, BEATRICE, CALANDO, NABUCCO, ELEKTRA, SAMSON, TAMIA, PANDORA, DREAM SP	3838987 593942	79,00
HEADREST COAST				
	HEADREST COAST	vzglavnik za vse modele kopalnih kadi naslon za glavu za sve modele kupaonskih kada	3838987 593928	103,00





	Program: Premazi			
ANTI-SLIP PREMAZ				
	ANTI-SLIP PREMAZ	protizdrsni premaz za kopalne in tuš kadi iz litega sanitarnega akrila in litega marmorja protiv sklizni premaz za kupaonske i tuš kade od lijevanog mramora i sanitarnog akrila		67,00
		minimalna količina za naručilo je 10 kos posameznega modela minimalna količina za naruđbu je 10 kos posamičnog modela		

Kopalniški dodatki

Kupaonski dodaci

Program: Čistila, Razkužila, Mast za ležaje

kolpa-san®

Model	Naziv in dimenzija izdelka Naziv i dimenzije produkta	Opis Opis	EAN koda EAN koda	Cena EUR Cijena EUR
Specialno čistilo KOLPA SAN				
	Specialno čistilo KOLPA SAN Specijalno sredstvo	krt = 20 x 0,5 l (Cena za kos / Cijena na komad 6,20 EUR) za odstranjevanje vodnega kamna na kopalnih in tuš kadeh, umivalnikih ter steklih tuš kabin / za odstranjivanje vodnog kamenca na kupaonskim i tuš kadama, umivaonicima i staklima tuš kabina	3838987 747291	124,00
Specialno čistilo ECO SAN				
	Specialno čistilo ECO SAN Specijalno sredstvo	krt = 20 x 0,5 l (Cena za kos / Cijena na komad 5,40 EUR) ekološko čistilo za odstranjevanje vodnega kamna na kopalnih in tuš kadeh, umivalnikih ter steklih tuš kabin ekološko sredstvo za odstranjivanje vodnog kamenca na kupaonskim i tuš kadama, umivaonicima i staklima tuš kabina	3838987 572220	108,00
KOLPA SAN - čistilo za popolno higieno masažnih kadi				
	KOLPA SAN - čistilo za popolno higieno masažnih kadi KOLPA SAN - sredstvo za potpuno higieno masažnih kada	krt = 10 x 1 l (Cena za kos / Cijena na komad 7,80 EUR) čistilo za popolno higieno masažnih kadi Kolpa san Sredstvo za potpuno higieno masažnih kada Kolpa san	3838987 747277	78,00
KERIL - Specialno čistilo za KERROCK				
	KERIL - Specialno čistilo za KERROCK KERIL - Specijalno sredstvo	krt = 12 x 0,5 l (Cena za kos / Cijena na komad 4,30 EUR)	3838987 747307	51,60
Mast za ležaje in tečaje tuš kabin				
	Mast za ležaje in tečaje tuš kabin Mast za ležajeve i šarke tuš kabina	krt = 10 kos x 20 ml (Cena za kos / Cijena na komad 4,50 EUR)	3838987 994169	45,00

Kopalniški dodatki
Kupaonski dodaci

