

Cenik / Cjenik 2023



kolpa·san

kolpa·san

Cenik / Cjenik 2023

Cenik velja / cjenik važi od 1.6.2023 do preklica / do opoziva.

KOLPA, d.o.o. Metlika

Rosalnice 5

8330 Metlika

Slovenia

phone: +386 7 36 92 100

www.kolpasan.si

Ident: 465857

Tisk: Printera, junij 2023

Konceptualna kopalnica

Konceptualna kupaonica

Str. 02

Kopalne in masažne kadi

Kade za kupanje i masažne kade

Str. 09

Masažne kabine, parne savne in masažni stebri

Masažne kabine, parne saune i masažni stupovi

Str. 119

Tuš kadi

Tuš kade

Str. 123

Tuš kabine

Tuš kabine

Str. 149

Kopalniško pohištvo

Kupaonski namještaj

Str. 185

Kopalniški dodatki

Kupaonski dodaci

Str. 261



Slike so simbolične. Pravilna razporeditev elementov je v TEHNIČNEM KATALOGU na www.kolpasan.si

Slike su simbolične. Točan raspored elemenata je u TEHNIČKOM KATALOGU na www.kolpasan.hr



MILO Collection Ferrazzano



Milo bathtub-FS 174 × 75 (188x78)

15



Milo basin 120, 70

203



BOUL Collection Ferrazzano



Konceptualna kopalnica
Konceptualna kupaonica

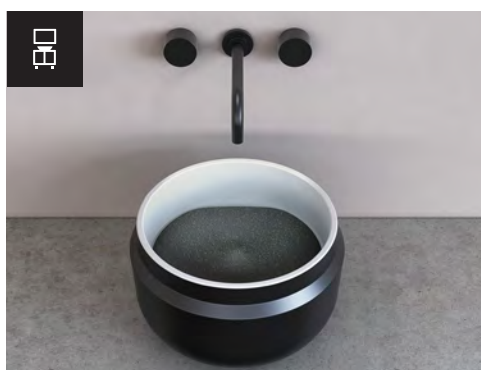
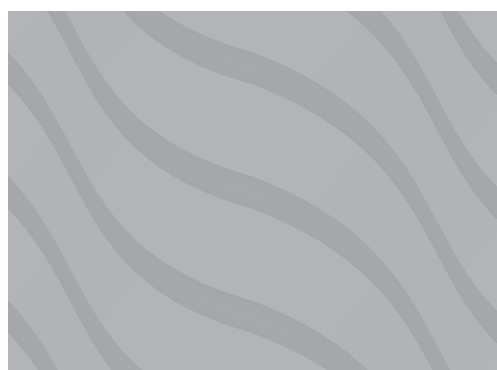

Boul basin Ø 40



207 Boul bathtub-FS 165 x 85



RAMONA Collection



Ramona 160, 80

209



Ramona basin 180 x 80

209



Ramona-FS 180 x 80

PANDORA Collection



Konceptualna kopalnica
Konceptualna kopalnica



Pandora 75, 110, 150

215



Pandora bathtub-FS
173 × 78, 163 × 68

21



Pandora bathtub
180 × 85, 170 × 75

106, 108



**Pandora tray 120 × 90, 120 × 80,
100 × 90, 100 × 80, 90 × 90**

131



BLANCHE Collection



Blanche 75, 110, 150



211 Blanche-FS 180 x 85



12

EVELIN Collection



Konceptualna kopalnica
Konceptualna kupalonica



Evelin bathtub 170 × 75, 170 × 70,
160 × 70, 150 × 70, 140 × 70 **111**



Evelin tray Q 120 × 90, 120 × 80 **137**



Evelin tray Q 90 × 90, 80 × 80 **137**



Evelin tray R 90 × 90, 80 × 80 **140**

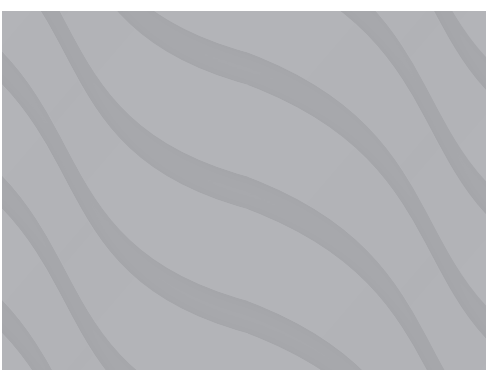

Evelin 55, 65, 80, 65 II, 80 II **253**



Cene so proizvajalčeve (brez DDV) Cijene su proizvođačeve (bez PDV-a).

Dobavni rok za vse proizvode je do 30 dni od dneva naročila (plačila), oziroma po dogovoru.

Opombe / Primjedbe:

Rok isporuke za sve proizvode je do 30 dana od dana narudbe (plaćanja), odnosno po dogovoru.

POSEBNE IZVEDBE tuš kabin, vrat, sten in zaslonov izven standardnih dimenzij:

- program DORSA, ATLAS, PULSAR, SOLE, SQ-LINE, LUNA – 40% dražje od cene po cjeniku
- program LIBRA, POLARIS, POLARIS FOLD, ANDROMEDA, CALYPSO – 20% dražje od cene po cjeniku.
- program RE WALL – 10% dražje od cene po cjeniku

Za veća odstopanja se izdela posebna ponudba.

POSEBNE IZVEDBE tuš kabina, vrata, stranica i zasloni van standardnih dimenzija:

- program DORSA, ATLAS, PULSAR, SOLE, SQ-LINE, LUNA – 40% skuplje od cijene navedene u cjeniku
- program LIBRA POLARIS, POLARIS FOLD, ANDROMEDA, CALYPSO – 20% skuplje od cijene navedene u cjeniku
- program RE WALL – 10% skuplje od cijene navedene u cjeniku

Za veća odstopanja izrađuje se posebna ponuda.



Konfigurator
tuš kabin
posebnih
dimenzij

Proizvajalec si pridržuje pravico, da zaradi tehničnega razvoja navedene podatke spremeni kadarkoli.

Proizvođač pridržava pravo, da zbog tehničkog razvoja navedene podatke promjeni u bilo kojem trenutku.

KOLPA, d.o.o. Metlika



Kopalne in masažne kadi

Kade za kupanje i masažne kade

Adam & Eva 195x125	88	Dolores 130x130	34	Libretto-L 160x100	50
Adam & Eva-FS 190x120	16	Dolores 140x140	32	Libretto-D 160x100	52
Atys-FS 180x85	14	Dolores 150x150	30	Libretto-L 170x110	46
Atys 180x85/0	14	Dream-SP 170x75	27	Libretto-D 170x110	48
Atys 200x100	14	Dream-SP 180x80	27	Lux 170x85	25
Atys DUO-FS 174x70	13	Dream-SP-L 170x75	44	Lux-FS 170x85	24
Beatrice-L 170x110(70)	54	Dream-SP-D 170x75	45	Marilyn-FS 180x90	20
Beatrice-D 170x110(70)	56	Dream-SP-L 180x80	44	Milo bathtub-FS 174x75 (188x78)	15
Betty 120x70	86	Dream-SP-D 180x80	45	Mini 100x70	117
Betty 130x70	84	Elektra 160x75	102	Nabucco 190x120	90
Betty 140x70	82	Elektra 170x70	100	Opera Ø 180	28
Betty 150x70	80	Elektra 170x75	98	Pandora bathtub 170x75	108
Betty 160x70	78	Elektra 170x80	96	Pandora bathtub 180x85	106
Betty 170x70	76	Elektra 180x80	94	Pandora bathtub-FS 163x68	21
Betty 170x75	74	Elektra 190x90	92	Pandora bathtub-FS 173x78	21
Betty 170x80	72	Elektra-SP 175x75	26	Ramona bathtub-FS 180x80	13
Betty 180x80	70	Elektra-SP 185x85	26	Royal 120x120	40
Betty 190x90	68	Elektra-SP-L 175x75	42	Royal 130x130	38
Betty 200x90	66	Elektra-SP-D 175x75	43	Samson 180x160	104
Blanche-FS 180x85	12	Elektra-SP-L 185x85	42	Soft 180x80	19
Boul bathtub-FS 165x85	15	Elektra-SP-D 185x85	43	Soft-FS 180x80	18
Calando-L 150x85	62	Evelin bathtub 140x70	111	Tamia 140x70	115
Calando-D 150x85	64	Evelin bathtub 150x70	111	Tamia 140x70/S	115
Calando-L 160x90	58	Evelin bathtub 160x70	111	Tamia 150x70	114
Calando-D 160x90	60	Evelin bathtub 170x70	111	Tamia 160x70	114
Comodo-FS 185x90	17	Evelin bathtub 170x75	110	Tamia 170x70	112
Copelia LIGHT-FS 180x80	11	Figaro 150x70	116	Tamia 170x75	113
Copelia LUX-FS 180x100	11	Figaro 160x80	116	Tamia 180x80	112
Copelia-FS 180x80	10	Figaro 170x75	116	Tristan-FS 197x117	10
Dalia-FS 170x80	22	Gaia 160x160	29		
Divante 140x140	36	Gloria-FS 180x80	12		

Slike so simbolične. Pravilna razporeditev elementov je v TEHNIČNEM KATALOGU na www.kolpasan.si
Slike su simbolične. Točan raspored elemenata je u TEHNIČKOM KATALOGU na www.kolpasan.hr

10













let garancije
godina jamstva

2

leti garancije
godine jamstva

Za kopalne kadi iz Kerrocka in litega sanitarnega akrila.
Za kupaonske kade od Kerrocka i od lijevanog sanitarnog akrila.

Masažni sistemi.
Masažni sustavi.







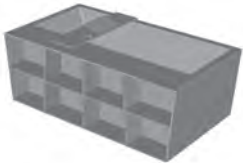

Kopalne in masažne kadi Kade za kupanje i masažne kade		Program: kolpa·san®		
Model	Naziv in dimenzija izdelka Naziv i dimenzije produkta	Opis Opis	EAN koda EAN koda	Cena EUR Cijena EUR
Tristan-FS 197x117				
	Tristan-FS 197x117 -WHITE Tristan-FS 197x117 -BLACK&WHITE	samostoječa ovalna kopalna kad iz KERROCK-a, s kromiranim prelivom, barva zunanjega dela: WHITE, BLACK samostoječa ovalna kada za kupanje od KERROCK-a, s kromiranim prelivom, boja vanjskog dijela: WHITE, BLACK	3838987 815983 3838987 592563	2.260,00 2.794,00
Dodatki za / Dodaci za Tristan-FS 196x117				
	HEADREST COAST	vzglavnik naslon za glavu	3838987 593928	108,00
	Specialno čistilo KOLPA SAN Specialno sredstvo za čiščenje Specialno čistilo ECO SAN Specialno sredstvo za čiščenje KERIL - Specialno čistilo za KERROCK KERIL - Specijalno sredstvo	karton 20 kosov / karton 20 komada (Cena za kos / Cijena na komad 6,50 EUR) karton 20 kosov / karton 20 komada (Cena za kos / Cijena na komad 5,70 EUR) krč = 12 x 0,5 l (Cena za kos / Cijena na komad 4,50 EUR)	3838987 747291 3838987 572220 3838987 747307	130,00 114,00 54,00
Copelia-FS 180x80				
	Copelia-FS 180x80 -WHITE	kopalna kad iz KERROCK-a, samostoječa, UP&DOWN sistem s sifonom / kada za kupanje iz KERROCK-a, samostoječa, UP&DOWN sustav sa sifonom	3838987 779346	2.514,00
Dodatki za / Dodaci za Copelia-FS 180x80				
	WATERFALL		enoročna armatura s tuš ročico in izlivom / jednoručna armatura s tuš ručicom i izljevom	3838987 734543 590,00
	GEYSER		enoročna arm. s tuš ročico in polnilno /odlivno prelivno gar. za polnjenje kadi jednoručna arm. s tuš ručicom i priljev/odljev prelivnom garniturom za punjenje kada	3838987 506287 633,00
	RAINDROP		enoročna armatura s tuš ročico in izlivom / jednoručna armatura s tuš ručicom i izljevom	3838987 726500 620,00
	HEADREST COAST	vzglavnik naslon za glavu	3838987 593928	108,00
	Specialno čistilo KOLPA SAN Specialno sredstvo za čiščenje Specialno čistilo ECO SAN Specialno sredstvo za čiščenje KERIL - Specialno čistilo za KERROCK KERIL - Specijalno sredstvo	karton 20 kosov / karton 20 komada (Cena za kos / Cijena na komad 6,50 EUR) karton 20 kosov / karton 20 komada (Cena za kos / Cijena na komad 5,70 EUR) krč = 12 x 0,5 l (Cena za kos / Cijena na komad 4,50 EUR)	3838987 747291 3838987 572220 3838987 747307	130,00 114,00 54,00
10	www.kolpasan.si	www.kolpasan.hr		

Kopalne in masažne kadi

Kade za kupanje i masažne kade

Program:

kolpa·san
BY KEROL

Model	Naziv in dimenzija izdelka Naziv i dimenzije produkta	Opis Opis	EAN koda EAN koda	Cena EUR Cijena EUR	
Copelia LUX-FS 180x100		Copelia LUX-FS 180x100 - WHITE	samostoječa kopalna kad iz Kerrocka s policami ter odlagalno polico za na kad, odlivna garnitura z UP&DOWN sistemom in avtomatskim prelivom	3838987 936541	3.865,00
Dodatki za / Dodaci za Copelia LUX-FS 180x100					
	HEADREST COAST	vzglavnik / naslon za glavu	3838987 593928	108,00	
	Specialno čistilo KOLPA SAN Specialno sredstvo za čiščenje Specialno čistilo ECO SAN Specialno sredstvo za čiščenje KERIL - Specialno čistilo za KERROCK KERIL - Specijalno sredstvo	karton 20 kosov / karton 20 komada (Cena za kos / Cijena na komad 6,50 EUR) karton 20 kosov / karton 20 komada (Cena za kos / Cijena na komad 5,70 EUR) krt = 12 x 0,5 l (Cena za kos / Cijena na komad 4,50 EUR)	3838987 747291 3838987 572220 3838987 747307	130,00 114,00 54,00	
Copelia LIGHT-FS 180x80					
	Copelia LIGHT-FS 180x80 - WHITE	samostoječa kopalna kad iz Kerrocka s transparentno akrilno steno, odlivno-prelivna garnitura z UP&DOWN sistemom.	3838987 590156	3.411,00	
	Copelia LIGHT-FS 180x80+CTL -WHITE	samostoječa kopalna kad iz Kerrocka s transparentno akrilno steno, vgrajena kromoterapija, 2 RGB lučki, odlivno-prelivna garnitura z UP&DOWN sistemom	3838987 510475	3.679,00	
	Copelia LIGHT-FS 180x80/MO Z+CTL -WHITE	samostoječa kopalna kad iz Kerrocka s transparentno akrilno steno, vgrajena kromoterapija, 2 RGB lučki, zračni masažni sistem, odlivno-prelivna garnitura z UP&DOWN sistemom	3838987 596196	4.622,00	
Dodatki za / Dodaci za Copelia LIGHT-FS 180x80					
	WATERFALL	enoročna armatura s tuš ročico in izlivom / jednoručna armatura s tuš ručicom i izljevom	3838987 734543	590,00	
	GEYSER	enoročna arm. s tuš ročico in polnilno /odlivno prelivno gar. za polnjenje kadi	3838987 506287	633,00	
	RAINDROP	enoročna armatura s tuš ročico in izlivom / jednoručna armatura s tuš ručicom i izljevom	3838987 726500	620,00	
	HEADREST SOFT HEADREST COAST	vzglavnik naslon za glavu	3838987 593942 3838987 593928	83,00 108,00	
	Specialno čistilo KOLPA SAN Specialno sredstvo za čiščenje Specialno čistilo ECO SAN Specialno sredstvo za čiščenje KERIL - Specialno čistilo za KERROCK KERIL - Specijalno sredstvo	karton 20 kosov / karton 20 komada (Cena za kos / Cijena na komad 6,50 EUR) karton 20 kosov / karton 20 komada (Cena za kos / Cijena na komad 5,70 EUR) krt = 12 x 0,5 l (Cena za kos / Cijena na komad 4,50 EUR)	3838987 747291 3838987 572220 3838987 747307	130,00 114,00 54,00	
	www.kolpa.hr	www.kolpa.si		11	







Kopalne in masažne kadi

Kade za kupanje i masažne kade

Program:**kolpa·san**
by KEROL

Model	Naziv in dimenzija izdelka Naziv i dimenzije produkta	Opis Opis	EAN koda EAN koda	Cena EUR Cijena EUR
Gloria-FS 180x80				
	Gloria-FS 180x80 -WHITE Gloria-FS 180x80 -BLACK&WHITE	samostoječa kopalna kad iz Kerrocka, UP&DOWN sistem s sifonom, barva zunanega dela: WHITE, BLACK samostoječa kada od Kerrocka, UP&DOWN sistem sa sifonom boja vanjskog dijela: WHITE, BLACK	3838987 622642 3838987 592556	2.685,00 3.136,00
Dodatki za / Dodaci za Gloria-FS 180x80				
	HEADREST COAST	vzglavnik naslon za glavu	3838987 593928	108,00
	Specialno čistilo KOLPA SAN Specialno sredstvo za čišćenje Specialno čistilo ECO SAN Specialno sredstvo za čišćenje KERIL - Specialno čistilo za KERROCK KERIL - Specijalno sredstvo	karton 20 kosov / karton 20 komada (Cena za kos / Cijena na komad 6,50 EUR) karton 20 kosov / karton 20 komada (Cena za kos / Cijena na komad 5,70 EUR) krt = 12 x 0,5 l (Cena za kos / Cijena na komad 4,50 EUR)	3838987 747291 3838987 572220 3838987 747307	130,00 114,00 54,00

Blanche-FS 180x85

	Blanche-FS 180x85 WHITE	samostoječa kopalna kad iz Kerrocka, UP&DOWN sistem s sifonom - BELA samostoječa kada od Kerrocka, UP&DOWN sustav sa sifonom - BIJELA	3838987 561090	2.221,00
	Blanche-FS 180x85 WHITE/ANTRACIT	samostoječa kopalna kad iz Kerrocka, UP&DOWN sistem s sifonom, barva zunanega dela - ANTRACIT samostoječa kada od Kerrocka, UP&DOWN sustav sa sifonom - ANTRACIT	3838987 561316	2.400,00
Dodatki za / Dodaci za Blanche-FS 180x85				
	HEADREST COAST	vzglavnik naslon za glavu	3838987 593928	108,00
	Specialno čistilo KOLPA SAN Specialno sredstvo za čišćenje Specialno čistilo ECO SAN Specialno sredstvo za čišćenje KERIL - Specialno čistilo za KERROCK KERIL - Specijalno sredstvo	karton 20 kosov / karton 20 komada (Cena za kos / Cijena na komad 6,50 EUR) karton 20 kosov / karton 20 komada (Cena za kos / Cijena na komad 5,70 EUR) krt = 12 x 0,5 l (Cena za kos / Cijena na komad 4,50 EUR)	3838987 747291 3838987 572220 3838987 747307	130,00 114,00 54,00

Kopalne in masažne kadi

Kade za kupanje i masažne kade









Program:**kolpa·san**
BY KERIL

Model	Naziv in dimenzija izdelka Naziv i dimenzije produkta	Opis Opis	EAN koda EAN koda	Cena EUR Cijena EUR
Ramona bathtub-FS 180x80				
	Ramona bathtub-FS 180x80	kopalna kad iz Kerrock-a, samostoječa, UP&DOWN sistem s sifonom / kada za kupanje iz Kerrock-a, samostoječa, UP&DOWN sustav sa sifonom	3838987 561255	3.101,00
Dodatki za / Dodaci za Ramona bathtub-FS 180x80				
	HEADREST COAST	vzglavnik naslon za glavu	3838987 593928	108,00
	Specialno čištilo KOLPA SAN Specialno sredstvo za čišćenje Specialno čištilo ECO SAN Specialno sredstvo za čišćenje KERIL - Specialno čištilo za KERROCK KERIL - Specijalno sredstvo	karton 20 kosov / karton 20 komada (Cena za kos / Cijena na komad 6,50 EUR) karton 20 kosov / karton 20 komada (Cena za kos / Cijena na komad 5,70 EUR) krt = 12 x 0,5 l	3838987 747291 3838987 572220 3838987 747307	130,00 114,00 54,00

Atys DUO-FS 174x70

	Atys DUO-FS 174x70 -WHITE	samostoječa kopalna kad iz Kerrocka, odlivna garnitura z UP&DOWN sistemom, barva plošče: BLACK samostoječa kada od Kerrocka, odljevna garnitura sa UP&DOWN sustavom, boja ploče: BLACK	3838987 622765	1.947,00
Dodatki za / Dodaci za Atys DUO-FS 174x70				
	HEADREST COAST	vzglavnik naslon za glavu	3838987 593928	108,00
	Specialno čištilo KOLPA SAN Specialno sredstvo za čišćenje Specialno čištilo ECO SAN Specialno sredstvo za čišćenje KERIL - Specialno čištilo za KERROCK KERIL - Specijalno sredstvo	karton 20 kosov / karton 20 komada (Cena za kos / Cijena na komad 6,50 EUR) karton 20 kosov / karton 20 komada (Cena za kos / Cijena na komad 5,70 EUR) krt = 12 x 0,5 l	3838987 747291 3838987 572220 3838987 747307	130,00 114,00 54,00



Kopalne in masažne kadi Kade za kupanje i masažne kade		Program: kolpa·san®		
Model	Naziv in dimenzija izdelka Naziv i dimenzije produkta	Opis Opis	EAN koda EAN koda	Cena EUR Cijena EUR
Atys-FS 180x85				
	Atys-FS 180x85 -WHITE	samostoječa kopalna kad iz Kerrocka, odlivno-prelivna garnitura z UP&DOWN sistemom samostoječa kada od Kerrocka, odljevno-preljevna garnitura sa UP&DOWN sustavom	3838987 622833	2.649,00
Atys 180x85/0				
	Atys 180x85/0 -WHITE	kopalna kad z oblogo iz Kerrocka, odlivno-prelivna garnitura z UP&DOWN sistemom / kada s oblogom od Kerrocka, odljevno-preljevna garnitura sa UP&DOWN sustavom	3838987 922841	2.397,00
Atys 200x100				
	Atys 200x100 -WHITE	kopalna kad iz Kerrocka, odlivno-prelivna garnitura z UP&DOWN sistemom, vgradnja na ploščice oz. v nivo ploščic, možnost prerezovanja roba kadi / kada od Kerrocka, odljevno-preljevna garnitura sa UP&DOWN sustavom, ugradnja na ploščice odn. na razinu ploščica, mogućnost obrezivanja ruba kade	3838987 621430	1.904,00
Dodatki za / Dodaci za Atys				
	WATERFALL		enoročna armatura s tuš ročico in izlivom / jednoručna armatura s tuš ručicom i izjevom	3838987 734543 590,00
	RAINDROP		enoročna armatura s tuš ročico in izlivom / jednoručna armatura s tuš ručicom i izjevom	3838987 726500 620,00
	HEADREST COAST		vzglavnik naslon za glavu	3838987 593928 108,00
	Specialno čistilo KOLPA SAN Specialno sredstvo za čišćenje Specialno čistilo ECO SAN Specialno sredstvo za čišćenje KERIL - Specialno čistilo za KERROCK KERIL - Specijalno sredstvo		karton 20 kosov / karton 20 komada (Cena za kos / Cijena na komad 6,50 EUR) karton 20 kosov / karton 20 komada (Cena za kos / Cijena na komad 5,70 EUR) krt = 12 x 0,5 l (Cena za kos / Cijena na komad 4,50 EUR)	3838987 747291 130,00 3838987 572220 114,00 3838987 747307 54,00

Kopalne in masažne kadi

Kade za kupanje i masažne kade

Program:

kolpa·san
BY KOLPA

Model	Naziv in dimenzija izdelka Naziv i dimenzije produkta	Opis Opis	EAN koda EAN koda	Cena EUR Cijena EUR
Milo bathtub-FS 174x75 (188x78)				
	Milo bathtub-FS 174x75 -WHITE	samostoječa kopalna kad z belo ploščo, UP&DOWN sistem s sifonom, barva zunanjega dela; WHITE, BLACK, SAND, V.RED, L.GREEN, P.BLUE samostoječa kada za kupanje s bijelom pločom, UP&DOWN sustav sa sifonom, boja vanjskog dijela; WHITE, BLACK, SAND, V.RED, L.GREEN, P.BLUE	3838987 591528	1.941,00
	Milo bathtub-FS 174x75 -BLACK&WHITE		3838987 592440	2.580,00
	Milo bathtub-FS 174x75 -SAND&WHITE		3838987 592457	2.580,00
	Milo bathtub-FS 174x75 -V.RED&WHITE		3838987 592464	2.580,00
	Milo bathtub-FS 174x75 -L.GREEN&WHITE		3838987 592471	2.580,00
	Milo bathtub-FS 174x75 -P.BLUE&WHITE		3838987 592488	2.580,00
Dodatki za / Dodaci za Milo bathtub				
	HEADREST COAST	vzglavnik naslon za glavu	3838987 593928	108,00
  	Specialno čištilo KOLPA SAN Specialno sredstvo za čišćenje Specialno čištilo ECO SAN Specialno sredstvo za čišćenje KERIL - Specialno čištilo za KERROCK KERIL - Specijalno sredstvo	karton 20 kosov / karton 20 komada (Cena za kos / Cijena na komad 6,50 EUR) karton 20 kosov / karton 20 komada (Cena za kos / Cijena na komad 5,70 EUR) krt = 12 x 0,5 l (Cena za kos / Cijena na komad 4,50 EUR)	3838987 747291 3838987 572220 3838987 747307	130,00 114,00 54,00

Boul bathtub-FS 165x85











	Boul bathtub-FS 165x85 -WHITE	Samostoječa kopalna kad v beli barvi s prelivno garnituro, UP&DOWN sistem s sifonom, barva zunanjega dela; WHITE, BLACK, SAND Samostojeća kada u bijeloj boji, sa preljevnom garnituro, UP&DOWN sustav sa sifonom, boja vanjskog dijela; WHITE, BLACK, SAND	3838987 591566	5.395,00
	Boul bathtub-FS 165x85 -BLACK&WHITE		3838987 592303	6.108,00
	Boul bathtub-FS 165x85 -SAND&WHITE		3838987 592310	6.108,00
Dodatki za / Dodaci za Boul bathtub				
  	Specialno čištilo KOLPA SAN Specialno sredstvo za čišćenje Specialno čištilo ECO SAN Specialno sredstvo za čišćenje KERIL - Specialno čištilo za KERROCK KERIL - Specijalno sredstvo	karton 20 kosov / karton 20 komada (Cena za kos / Cijena na komad 6,50 EUR) karton 20 kosov / karton 20 komada (Cena za kos / Cijena na komad 5,70 EUR) krt = 12 x 0,5 l (Cena za kos / Cijena na komad 4,50 EUR)	3838987 747291 3838987 572220 3838987 747307	130,00 114,00 54,00



Kopalne in masažne kadi

Kade za kupanje i masažne kade













Program:**kolpa·san**
by HANSON

Model	Naziv in dimenzija izdelka Naziv i dimenzije produkta	Opis Opis	EAN koda EAN koda	Cena EUR Cijena EUR
Adam & Eva-FS 190x120				
	Adam & Eva-FS 190x120 WHITE	samostoječa kopalna kad s prelivno garnituro - kad in obloga iz enega dela samostoječa kada s prelivnom garniturom - kada i obloga su iz jednog dijela	3838987 561132	2.533,00
	Zračni masažni sistem Zračni masažni sistem ELEKTRONSKI Adam & Eva-FS 190x120/MO	samostoječa BELA samostoječa BIJELA	3838987 576754	3.401,00
Dodatki za / Dodaci za Adam & Eva-FS 190x120				
	GEYSER 	enoročna arm. s tuš ročico in polnilno /odlivno prelivno gar. za polnjenje kadi jednoročna arm. s tuš ručicom i priljev/odljev prelivnom garniturom za punjenje kada	3838987 506287	633,00
	RAINDROP 	enoročna armatura s tuš ročico in izlivom / jednoročna armatura s tuš ručicom i izljevom	3838987 726500	620,00
	HEADREST COAST	vzglavnik naslon za glavu	3838987 593928	108,00
	Chromoterapia (CTL) Chromoterapia (CTL)	2 LED lučki s samostojno tipkovnico 2 LED svjetla sa samostalnom tipkovnicom		401,00
	ANTI-SLIP PREMAZ	protizdrnsni premaz za kopalne kadi protiv klizni premaz za kupaonske kade (min. kol. 10 kos)		70,00
	Specialno čistilo KOLPA SAN Specialno sredstvo za čišćenje Specialno čistilo ECO SAN Specialno sredstvo za čišćenje Čistilo za masažne sisteme Sredstvo za čišćenje masažnih sistema	karton 20 kosov / karton 20 komada (Cena za kos / Cijena na komad 6,50 EUR) karton 20 kosov / karton 20 komada (Cena za kos / Cijena na komad 5,70 EUR) karton 10 kosov / karton 10 komada (Cena za kos / Cijena na komad 8,20 EUR)	3838987 747291 3838987 572220 3838987 747277	130,00 114,00 82,00





Kopalne in masažne kadi

Kade za kupanje i masažne kade

Program:**kolpa·san**
BY KOLPA

Model	Naziv in dimenzija izdelka Naziv i dimenzije produkta	Opis Opis	EAN koda EAN koda	Cena EUR Cijena EUR
Comodo-FS 185x90				
	Comodo-FS 185x90 WHITE	samostoječa kopalna kad s prelivno garnituro - kad in obloga iz enega dela samostoječa kada s prelivnom garniturom - kada i obloga su iz jednog dijela	3838987 593836	1.409,00
	Comodo-FS 185x90 BLACK & WHITE	samostoječa kopalna kad s prelivno garnituro, obloga in kad iz enega dela - ČRNO, SIVO / BELA samostoječa kada s prelivnom garniturom obloga i kada su iz jednog dijela - CRNO, SIVO / BIJELA	3838987 593799	1.644,00
	Comodo-FS 185x90 GREY & WHITE		3838987 922919	1.644,00
Zračni masažni sistem Zračni masažni sistem ELEKTRONSKI				
	Comodo-FS 185x90/MO WHITE	samostoječa BELA / samostoječa BIJELA	3838987 570363	2.416,00
	Comodo-FS 185x90/MO BLACK & WHITE	samostoječa ČRNO, SIVO / BELA	3838987 591825	2.622,00
	Comodo-FS 185x90/MO GREY & WHITE	samostoječa CRNO, SIVO / BIJELA	3838987 518068	2.622,00
Dodatki za / Dodaci za Comodo-FS 185x90				
	WATERFALL	 enoročna armatura s tuš ročico in izlivom / jednoručna armatura s tuš ručicom i izljevom	3838987 734543	590,00
	GEYSER	 enoročna arm. s tuš ročico in polnilno /odlivno prelivno gar. za polnjenje kadi jednoručna arm. s tuš ručicom i priljev/odljev prelivnom garniturom za punjenje kada	3838987 506287	633,00
	RAINDROP	 enoročna armatura s tuš ročico in izlivom / jednoručna armatura s tuš ručicom i izljevom	3838987 726500	620,00
	HEADREST COAST	vzglavnik naslon za glavu	3838987 593928	108,00
	Chromoterapia (CTL) Chromoterapia (CTL)	2 LED lučki s samostojno tipkovnicom 2 LED svjetla sa samostalnom tipkovnicom		401,00
	ANTI-SLIP PREMAZ	protizdrсни premaz za kopalne kadi protiv klizni premaz za kupaonske kade (min. kol. 10 kos)		70,00
	Specialno čištilo KOLPA SAN Specialno sredstvo za čišćenje	karton 20 kosov / karton 20 komada (Cena za kos / Cijena na komad 6,50 EUR)	3838987 747291	130,00
	Specialno čištilo ECO SAN Specialno sredstvo za čišćenje	karton 20 kosov / karton 20 komada (Cena za kos / Cijena na komad 5,70 EUR)	3838987 572220	114,00
	Čistilo za masažne sisteme Sredstvo za čišćenje masažnih sistema	karton 10 kosov / karton 10 komada (Cena za kos / Cijena na komad 8,20 EUR)	3838987 747277	82,00









Kopalne in masažne kadi Kade za kupanje i masažne kade		Program: kolpa·san®		
Model	Naziv in dimenzija izdelka Naziv i dimenzije produkta	Opis Opis	EAN koda EAN koda	Cena EUR Cijena EUR
Soft-FS 180x80				
	Soft-FS 180x80 WHITE	samostoječa kopalna kad, kad in obloga iz enega dela, odlivna garnitura z UP&DOWN sistemom, barva: BELA Samostoječa kada, kada i obloga su iz jednog dijela, odljevna garnitura sa UP&DOWN sustavom, boja: BIJELA	3838987 922803	1.508,00
Dodatki za / Dodaci za Soft-FS 180x80				
	HEADREST COAST	vzglavnik naslon za glavu	3838987 593928	108,00
	ANTI-SLIP PREMAZ	protizdrсни premaz za kopalne kadi protiv klizni premaz za kupaonske kade (min. kol. 10 kos)		70,00
	Specialno čistilo KOLPA SAN Specialno sredstvo za čišćenje Specialno čistilo ECO SAN Specialno sredstvo za čišćenje	karton 20 kosov / karton 20 komada (Cena za kos / Cijena na komad 6,50 EUR) karton 20 kosov / karton 20 komada (Cena za kos / Cijena na komad 5,70 EUR)	3838987 747291 3838987 572220	130,00 114,00











Kopalne in masažne kadi

Kade za kupanje i masažne kade

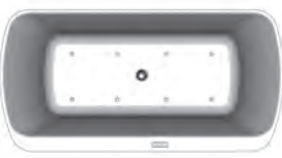
Program:**kolpa·san**
BY PROKOL

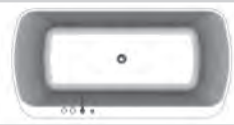
Model	Naziv in dimenzija izdelka Naziv i dimenzije produkta	Opis Opis	EAN koda EAN koda	Cena EUR Cijena EUR
Soft 180x80				
	Soft 180x80 WHITE	kopalna kad za vgradnjo kada za ugradnju	3838987 922827	373,00
Dodatki za / Dodaci za Soft 180x80				
	UP&DOWN, WHITE	prelivna garnitura s sifonom, bela preljevna garnitura sa sifonom, bijela	3838987 922759	65,00
	HEADREST COAST	vzglavnik naslon za glavu	3838987 593928	108,00
	PKK 501	podnožje kopalne kadi za vgradnjo podnožje kupaonske kade za ugradnju	3838987 764878	29,00
	ANTI-SLIP PREMAZ	protizdrsni premaz za kopalne kadi protiv klizni premaz za kupaonske kade (min. kol. 10 kos)		70,00
	Specialno čištilo KOLPA SAN Specialno sredstvo za čišćenje	karton 20 kosov / karton 20 komada (Cena za kos / Cijena na komad 6,50 EUR)	3838987 747291	130,00
	Specialno čištilo ECO SAN Specialno sredstvo za čišćenje	karton 20 kosov / karton 20 komada (Cena za kos / Cijena na komad 5,70 EUR)	3838987 572220	114,00





Kopalne in masažne kadi
Kade za kupanje i masažne kade

Kopalne in masažne kadi Kade za kupanje i masažne kade		Program: kolpa·san®		
Model	Naziv in dimenzija izdelka Naziv i dimenzije produkta	Opis Opis	EAN koda EAN koda	Cena EUR Cijena EUR
Marilyn-FS 180x90				
	Marilyn-FS 180x90 WHITE	samostoječa kopalna kad s prelivno garnituro, kad in obloga iz enega dela - BELA samostoječa kada s prelivnom garniturom kada i obloga su iz jednog dijela - BIJELA	3838987 593973	1.475,00
	Marilyn-FS 180x90 BLACK & WHITE	samostoječa kopalna kad s prelivno garnituro, obloga in kad iz enega dela - ČRNO, SIVO / BELA samostoječa kada s prelivnom garniturom obloga i kada su iz jednog dijela - CRNO, SIVO / BIJELA	3838987 593843	1.708,00
	Marilyn-FS 180x90 GREY & WHITE		3838987 927310	1.708,00
Zračni masažni sistem Zračni masažni sistem ELEKTRONSKI				
	Marilyn-FS 180x90/MO WHITE	samostoječa BELA / samostoječa BIJELA	3838987 596455	2.474,00
	Marilyn-FS 180x90/MO BLACK & WHITE	samostoječa ČRNO, SIVO / BELA	3838987 592211	2.679,00
	Marilyn-FS 180x90/MO GREY & WHITE	samostoječa CRNO, SIVO / BIJELA	3838987 518051	2.679,00
Dodatki za / Dodaci za Marilyn-FS 180x90				
	WATERFALL	enoročna armatura s tuš ročico in izlivom / jednoručna armatura s tuš ručicom i izljevom	3838987 734543	590,00
	GEYSER	enoročna arm. s tuš ročico in polnilno /odlivno prelivno gar. za polnjenje kadi jednoručna arm. s tuš ručicom i priljev/odljev prelivnom garniturom za punjenje kada	3838987 506287	633,00
	RAINDROP	enoročna armatura s tuš ročico in izlivom / jednoručna armatura s tuš ručicom i izljevom	3838987 726500	620,00
	HEADREST COAST	vzglavnik naslon za glavu	3838987 593928	108,00
	Chromoterapia (CTL) Chromoterapia (CTL)	2 LED lučki s samostojno tipkovnicom 2 LED svjetla sa samostalnom tipkovnicom		401,00
	ANTI-SLIP PREMAZ	protizdrnsni premaz za kopalne kadi protiv klizni premaz za kupaonske kade (min. kol. 10 kos)		70,00
	Specialno čištilo KOLPA SAN Specialno sredstvo za čišćenje Specialno čištilo ECO SAN Specialno sredstvo za čišćenje Čistilo za masažne sisteme Sredstvo za čišćenje masažnih sistema	karton 20 kosov / karton 20 komada (Cena za kos / Cijena na komad 6,50 EUR) karton 20 kosov / karton 20 komada (Cena za kos / Cijena na komad 5,70 EUR) karton 10 kosov / karton 10 komada (Cena za kos / Cijena na komad 8,20 EUR)	3838987 747291 3838987 572220 3838987 747277	130,00 114,00 82,00





Kopalne in masažne kadi

Kade za kupanje i masažne kade

Program:**kolpa·san**
BY KOLPA

Model	Naziv in dimenzija izdelka Naziv i dimenzije produkta	Opis Opis	EAN koda EAN koda	Cena EUR Cijena EUR
Pandora bathtub-FS 173, 163				
	Pandora bathtub-FS 173x78 WHITE	samostoječa kopalna kad, UP&DOWN sistem s sifonom, kad in obloga iz enega dela samostoječa kada, UP&DOWN sustav sa sifonom, kada i obloga su iz jednog dijela	3838987 593157	1.603,00
	Pandora bathtub-FS 163x68 WHITE	samostoječa kopalna kad, UP&DOWN sistem s sifonom, kad in obloga iz enega dela samostoječa kada, UP&DOWN sustav sa sifonom, kada i obloga su iz jednog dijela	3838987 593423	1.572,00
Dodatki za / Dodaci za Pandora bathtub-FS 173, 163				
	HEADREST COAST	vzglavnik naslon za glavu	3838987 593928	108,00
	ANTI-SLIP PREMAZ	protizdrsni premaz za kopalne kadi protiv klizni premaz za kupaonske kade (min. kol. 10 kos)		70,00
	Specialno čištilo KOLPA SAN Specialno sredstvo za čišćenje	karton 20 kosov / karton 20 komada (Cena za kos / Cijena na komad 6,50 EUR)	3838987 747291	130,00
	Specialno čištilo ECO SAN Specialno sredstvo za čišćenje	karton 20 kosov / karton 20 komada (Cena za kos / Cijena na komad 5,70 EUR)	3838987 572220	114,00



Kopalne in masažne kadi Kade za kupanje i masažne kade		Program: kolpa·san®		
Model	Naziv in dimenzija izdelka Naziv i dimenzije produkta	Opis Opis	EAN koda EAN koda	Cena EUR Cijena EUR
Dalia-FS 170x80				
	Dalia-FS 170x80 WHITE	samostoječa kopalna kad s prelivno garnituro, kad in obloga iz enega dela - BELA samostoječa kada s prelivnom garniturom kada i obloga su iz jednog dijela - BIJELA	3838987 561149	1.466,00
	Dalia-FS 170x80 BLACK & WHITE	samostoječa kopalna kad s prelivno garnituro, obloga in kad iz enega dela - ČRNO, SIVO / BELA samostoječa kada s prelivnom garniturom obloga i kada su iz jednog dijela - CRNO, SIVO / BIJELA	3838987 561767	1.525,00
	Dalia-FS 170x80 GREY & WHITE		3838987 927334	1.525,00
Dodatki za / Dodaci za Dalia-FS 170x80				
	HEADREST COAST	vzglavnik naslon za glavu	3838987 593928	108,00
	ANTI-SLIP PREMAZ	protizdrsni premaz za kopalne kadi protiv klizni premaz za kupaonske kade (min. kol. 10 kos)		70,00
	Specialno čistilo KOLPA SAN Specialno sredstvo za čišćenje Specialno čistilo ECO SAN Specialno sredstvo za čišćenje	karton 20 kosov / karton 20 komada (Cena za kos / Cijena na komad 6,50 EUR)	3838987 747291	130,00
		karton 20 kosov / karton 20 komada (Cena za kos / Cijena na komad 5,70 EUR)	3838987 572220	114,00









Lux-FS 170x85



Lux 170x85

Kopalne in masažne kadi
Kade za kupanje i masažne kade















Kopalne in masažne kadi Kade za kupanje i masažne kade		Program: kolpa·san [®]		
Model	Naziv in dimenzija izdelka Naziv i dimenzije produkta	Opis Opis	EAN koda EAN koda	Cena EUR Cijena EUR
Lux-FS 170x85				
	Lux-FS 170x85 WHITE	samostoječa kopalna kad, kad in obloga iz enega dela, odlivna garnitura z UP&DOWN sistemom, barva: BELA Samostoječa kada, kada i obloga su iz jednog dijela, odljevna garnitura sa UP&DOWN sustavom, boja: BIJELA	3838987 922810	1.441,00
Dodatki za / Dodaci za Lux-FS 170x85				
	WATERFALL	enoročna armatura s tuš ročico in izlivom / jednoručna armatura s tuš ručicom i izljevom	3838987 734543	590,00
	GEYSER	enoročna arm. s tuš ročico in polnilno /odlivno prelivno gar. za polnjenje kadi jednoručna arm. s tuš ručicom i priljev/odljev prelivnom garnituro za punjenje kadi	3838987 506287	633,00
	RAINDROP	enoročna armatura s tuš ročico in izlivom / jednoručna armatura s tuš ručicom i izljevom	3838987 726500	620,00
	HEADREST COAST	vzglavnik naslon za glavu	3838987 593928	108,00
	ANTI-SLIP PREMAZ	protizdrsni premaz za kopalne kadi protiv klizni premaz za kupaonske kade (min. kol. 10 kos)		70,00
	Specialno čistilo KOLPA SAN Specialno sredstvo za čišćenje Specialno čistilo ECO SAN Specialno sredstvo za čišćenje	karton 20 kosov / karton 20 komada (Cena za kos / Cijena na komad 6,50 EUR) karton 20 kosov / karton 20 komada (Cena za kos / Cijena na komad 5,70 EUR)	3838987 747291 3838987 572220	130,00 114,00





Kopalne in masažne kadi

Kade za kupanje i masažne kade

Program:**kolpa·san**
BY PROKOL

Model	Naziv in dimenzija izdelka Naziv i dimenzije produkta	Opis Opis	EAN koda EAN koda	Cena EUR Cijena EUR
Lux 170x85				
	Lux 170x85 WHITE	kopalna kad za vgradnjo kada za ugradnju	3838987 922834	357,00
Dodatki za / Dodaci za Lux 170x85				
	WATERFALL 	enoročna armatura s tuš ročico in izlivom / jednoručna armatura s tuš ručicom i izljevom	3838987 734543	590,00
	GEYSER 	enoročna arm. s tuš ročico in polnilno /odlivno prelivno gar. za polnjenje kadi jednoručna arm. s tuš ručicom i priljev/odljev prelivnom garniturom za punjenje kada	3838987 506287	633,00
	RAINDROP 	enoročna armatura s tuš ročico in izlivom / jednoručna armatura s tuš ručicom i izljevom	3838987 726500	620,00
	UP&DOWN, WHITE	prelivna garnitura s sifonom, bela prelivna garnitura sa sifonom, bijela	3838987 922759	65,00
	HEADREST COAST	vzglavnik naslon za glavu	3838987 593928	108,00
	Servisno prezračevalni pokrov z rešetko Servisno ventilacijski pokrov s rešetkom	za masažne kadi za vgradnjo (45x45 cm) za masažne kade za ugradnju (45x45 cm)	3838987 534808	95,00
	PKK 501	podnožje kopalne kadi za vgradnjo podnožje kupaonske kade za ugradnju	3838987 764878	29,00
	ANTI-SLIP PREMAZ	protizdrsni premaz za kopalne kadi protiv klizni premaz za kupaonske kade (min. kol. 10 kos)		70,00
	Specialno čistilo KOLPA SAN Specialno sredstvo za čišćenje Specialno čistilo ECO SAN Specialno sredstvo za čišćenje	karton 20 kosov / karton 20 komada (Cena za kos / Cijena na komad 6,50 EUR) karton 20 kosov / karton 20 komada (Cena za kos / Cijena na komad 5,70 EUR)	3838987 747291 3838987 572220	130,00 114,00





















Kopalne in masažne kadi Kade za kupanje i masažne kade		Program: kolpa·san [®]		
Model	Naziv in dimenzija izdelka Naziv i dimenzije produkta	Opis Opis	EAN koda EAN koda	Cena EUR Cijena EUR
Elektra-SP 185, 175				
	Elektra-SP 185x85	kopalna kad s prelivno garnituro	3838987 513469	1.322,00
	Elektra-SP 175x75	- kad in obloga iz enega dela kada s prelevnom garniturom - kada i obloga su iz jednog dijela	3838987 513490	1.278,00
Dodatki za / Dodaci za Elektra-SP 185, 175				
	HEADREST SOFT	vzglavnik naslon za glavu	3838987 593942	83,00
	HEADREST COAST		3838987 593928	108,00
	Suhomontažna zaključna letev Završna letva u sistemu suhe montaže	karton 25 kosov / karton 25 komada (Cena za kos / Cijena na komad 32,00 EUR)	3838987 903116	800,00
	ANTI-SLIP PREMAZ	protizdrsni premaz za kopalne kadi protiv klizni premaz za kupaonske kade (min. kol. 10 kos)		70,00
	Specialno čistilo KOLPA SAN Specialno sredstvo za čišćenje	karton 20 kosov / karton 20 komada (Cena za kos / Cijena na komad 6,50 EUR)	3838987 747291	130,00
	Specialno čistilo ECO SAN Specialno sredstvo za čišćenje	karton 20 kosov / karton 20 komada (Cena za kos / Cijena na komad 5,70 EUR)	3838987 572220	114,00

Kopalne in masažne kadi

Kade za kupanje i masažne kade

Program:

kolpa·san
BY KOLPA











Model	Naziv in dimenzija izdelka Naziv i dimenzije produkta	Opis Opis	EAN koda EAN koda	Cena EUR Cijena EUR
Dream-SP 180, 170				
	Dream-SP 180x80 Dream-SP 170x75	kopalna kad s prelivno garnituro - kad in obloga iz enega dela kada s preljevnom garniturom - kada i obloga su iz jednog dijela	3838987 570394 3838987 570554	1.140,00 1.089,00
	Zračni masažni sistem Zračni masažni sistem ELEKTRONSKI Dream-SP 180x80/MO	kopalna kad s prelivno garnituro - kad in obloga iz enega dela kada s preljevnom garniturom - kada i obloga su iz jednog dijela	3838987 576921	2.181,00
	Zračni masažni sistem Zračni masažni sistem ELEKTRONSKI Dream-SP 170x75/MO	kopalna kad s prelivno garnituro - kad in obloga iz enega dela kada s preljevnom garniturom - kada i obloga su iz jednog dijela	3838987 577195	2.101,00
Dodatki za / Dodaci za				
Dream-SP 180x80, 170x75				
 	180x80 170x75	WATERFALL 	enoročna armatura s tuš ročico in izlivom / jednoručna armatura s tuš ručicom i izljevom	3838987 734543 590,00
 	180x80 170x75	GEYSER 	enoročna arm. s tuš ročico in polnilno /odlivno prelivno gar. za polnjenje kadi jednoručna arm. s tuš ručicom i priljev/odljev preljevnom garniturom za punjenje kada	3838987 506287 633,00
 	180x80 170x75	RAINDROP 	enoročna armatura s tuš ročico in izlivom / jednoručna armatura s tuš ručicom i izljevom	3838987 726500 620,00
 		HEADREST SOFT HEADREST COAST	vzglavnik naslon za glavu	3838987 593942 83,00 3838987 593928 108,00
		Suhomontažna zaključna letva Završna letva u sistemu suhe montaže	karton 25 kosov / karton 25 komada (Cena za kos / Cijena na komad 32,00 EUR)	3838987 903116 800,00
		Chromoterapia (CTL) Chromoterapia (CTL)	2 LED lučki s samostojno tipkovnicu 2 LED svjetla sa samostalnom tipkovnicom	401,00
		ANTI-SLIP PREMAZ	protizdrsni premaz za kopalne kadi protiv klizni premaz za kupaonske kade (min. kol. 10 kos)	70,00
		Specialno čištilo KOLPA SAN Specialno sredstvo za čišćenje Specialno čištilo ECO SAN Specialno sredstvo za čišćenje Čištilo za masažne sisteme Sredstvo za čišćenje masažnih sistema	karton 20 kosov / karton 20 komada (Cena za kos / Cijena na komad 6,50 EUR) karton 20 kosov / karton 20 komada (Cena za kos / Cijena na komad 5,70 EUR) karton 10 kosov / karton 10 komada (Cena za kos / Cijena na komad 8,20 EUR)	130,00 114,00 82,00



Kopalne in masažne kadi

Kade za kupanje i masažne kade









Program:kolpa·san[®]

Model	Naziv in dimenzija izdelka Naziv i dimenzije produkta	Opis Opis	EAN koda EAN koda	Cena EUR Cijena EUR
Opera 180				
	Vital masažni sistem + mikrošobe Vital masažni sistem ELEKTRONSKI Opera 180	okrogla masažna kopalna kad z ročajem za vgradnjo / ugradna okrogla masažna kupaonska kada sa ručicom okrogla masažna kopalna kad z ročajem in z oblogo / okrogla masažna kupaonska kada sa ručicom i oblogom	3838987 571902 3838987 571919	4.279,00 4.744,00
Dodatki za / Dodaci za Opera 180				
	WATERFALL 	enoročna armatura s tuš ročico in izlivom / jednoručna armatura s tuš ručicom i izljevom	3838987 734543	590,00
	GEYSER 	enoročna arm. s tuš ročico in polnilno /odlivno prelivno gar. za polnjenje kadi / jednoručna arm. s tuš ručicom i priljev/odljev prelivnom garniturom za punjenje kada	3838987 506287	633,00
	RAINDROP 	enoročna armatura s tuš ročico in izlivom / jednoručna armatura s tuš ručicom i izljevom	3838987 726500	620,00
	HEADREST COAST	vzglavnik naslon za glavu	3838987 593928	108,00
	Servisno prezračevalni pokrov z rešetko Servisno ventilacijski pokrov s rešetkom	za masažne kadi za vgradnjo (45x45 cm) za masažne kade za ugradnju (45x45 cm)	3838987 534808	95,00
	Specialno čistilo KOLPA SAN Specialno sredstvo za čiščenje	karton 20 kosov / karton 20 komada (Cena za kos / Cijena na komad 6,50 EUR)	3838987 747291	130,00
	Specialno čistilo ECO SAN Specialno sredstvo za čiščenje	karton 20 kosov / karton 20 komada (Cena za kos / Cijena na komad 5,70 EUR)	3838987 572220	114,00
	Čistilo za masažne sisteme Sredstvo za čiščenje masažnih sistema	karton 10 kosov / karton 10 komada (Cena za kos / Cijena na komad 8,20 EUR)	3838987 747277	82,00

Kopalne in masažne kadi

Kade za kupanje i masažne kade

Program:**kolpa·san**
by KOLPA







Model	Naziv in dimenzija izdelka Naziv i dimenzije produkta	Opis Opis	EAN koda EAN koda	Cena EUR Cijena EUR
Gaia 160x160				
	Vital masažni sistem + mikrošobe Vital masažni sistem ELEKTRONSKI Gaia 160x160	kotna masažna kopalna kad za vgradnjo, z enoročno armaturo in tuš ročico WATERFALL ugradna kutna masažna kupaonska kada, jednoručna armatura i tuš ručka WATERFALL	3838987 513872	4.760,00
	Vital masažni sistem + mikrošobe Vital masažni sistem ELEKTRONSKI Gaia 160/0	kotna masažna kopalna kad z oblogo, enoročno armaturo in tuš ročico WATERFALL kutna masažna kupaonska kada s oblogom, jednoručna armatura i tuš ručka WATERFALL	3838987 513919	4.955,00
	Vital masažni sistem + mikrošobe Vital masažni sistem ELEKTRONSKI Gaia 160x160 - polnjenje kadi preko preliva - punjenje kade preko preljeva	kotna masažna kopalna kad za vgradnjo, z enoročno armaturo in tuš ročico GEYSER ugradna kutna masažna kupaonska kada, jednoručna armatura i tuš ručka GEYSER	3838987 513889	4.730,00
	Vital masažni sistem + mikrošobe Vital masažni sistem ELEKTRONSKI Gaia 160/0 - polnjenje kadi preko preliva - punjenje kade preko preljeva	kotna masažna kopalna kad z oblogo, enoročno armaturo in tuš ročico GEYSER kutna masažna kupaonska kada s oblogom, jednoručna armatura i tuš ručka GEYSER	3838987 513926	4.931,00
Dodatki za / Dodaci za Gaia 160x160				
	Stopnica Gaia stepenica Gaia	- bela / bijela	3838987 903314	196,00
	Zidni montažni set Zidni montažni set	za kopalne in tuš kadi za vgradnjo za kupaonske i tuš kade za ugradnju	3838987 704362	12,00
	Suhomontažna zaključna letva Završna letva u sistemu suhe montaže	karton 25 kosov / karton 25 komada (Cena za kos / Cijena na komad 32,00 EUR)	3838987 903116	800,00
	Servisno prezračevalni pokrov z rešetko Servisno ventilacijski pokrov s rešetkom	za masažne kadi za vgradnjo (45x45 cm) za masažne kade za ugradnju (45x45 cm)	3838987 534808	95,00
	Specialno čistilo KOLPA SAN Specialno sredstvo za čišćenje	karton 20 kosov / karton 20 komada (Cena za kos / Cijena na komad 6,50 EUR)	3838987 747291	130,00
	Specialno čistilo ECO SAN Specialno sredstvo za čišćenje	karton 20 kosov / karton 20 komada (Cena za kos / Cijena na komad 5,70 EUR)	3838987 572220	114,00
	Čistilo za masažne sisteme Sredstvo za čišćenje masažnih sistema	karton 10 kosov / karton 10 komada (Cena za kos / Cijena na komad 8,20 EUR)	3838987 747277	82,00



Kopalne in masažne kadi

Kade za kupanje i masažne kade

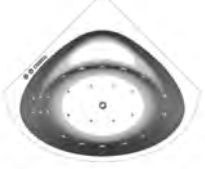
Program:**kolpa·san**
BY KOLPA





Model	Naziv in dimenzija izdelka Naziv i dimenzije produkta	Opis Opis	EAN koda EAN koda	Cena EUR Cijena EUR
Dolores 150x150				
	Dolores 150x150	kopalna kad za vgradnjo kada za ugradnju	3838987 565208	490,00
	Obloga Dolores 150	obloga za kopalno kad obloga za kupaonsku kadu	3838987 565239	272,00
	CKM 120-150	podnožje kopalne kadi za oblogo podnožje kupaonske kade za oblogu	3838987 573043	167,00
	Vodni masažni sistem I. Vodeni masažni sistem I. PNEVMATSKI Dolores 150x150	z oblogo s oblogom z oblogo + mikrošobe s oblogom + mikromlaznice	3838987 927617 3838987 927624	1.908,00 2.474,00
	Kombinirani (vodni in zračni) masažni sistem / Kombinirani (vodeni i zračni) masažni sistem ELEKTRONSKI Dolores 150x150	z oblogo s oblogom z oblogo + mikrošobe s oblogom + mikromlaznice	3838987 927631 3838987 927648	3.124,00 3.690,00
	Vital masažni sistem Vital masažni sistem ELEKTRONSKI Dolores 150x150	z oblogo + mikrošobe s oblogom + mikromlaznice	3838987 927655	4.715,00
Vgradnja mikrošob v kad Ugradnja mikromlaznica u kadu Dolores 150x150				
	Prikaz vgradnje mikrošob Prikaz ugradnje mikromlaznica Dolores 150x150			

Kopalne in masažne kadi

Kade za kupanje i masažne kade

Program:

kolpa·san
BY KOLPA







Model	Naziv in dimenzija izdelka Naziv i dimenzije produkta	Opis Opis	EAN koda EAN koda	Cena EUR Cijena EUR
Dodatki za / Dodaci za Dolores 150x150				
	GEYSER 	enoročna arm. s tuš ročico in polnilno /odlivno prelivno gar. za polnjenje kadi jednoručna arm. s tuš ručicom i priljev/odljev prelivnom garnituroom za punjenje kada	3838987 506287	633,00
	RAINDROP 	enoročna armatura s tuš ročico in izlivom / jednoručna armatura s tuš ručicom i izljevom	3838987 726500	620,00
	UP&DOWN, WHITE	prelivna garnitura s sifonom, bela preljevna garnitura sa sifonom, bijela	3838987 922759	65,00
	PAL 650, CHR	prelivna garnitura s sifonom, krom preljevna garnitura sa sifonom, krom	3838987 746270	58,00
	HEADREST SOFT	vzglavnik naslon za glavu	3838987 593942	83,00
	HEADREST COAST	vzglavnik naslon za glavu	3838987 593928	108,00
	1001/B	podnožje kopalne kadi za vgradnjo podnožje kupaonske kade za ugradnju	3838987 876502	51,00
	Zidni montažni set Zidni montažni set	za kopalne in tuš kadi za vgradnjo za kupaonske i tuš kade za ugradnju	3838987 704362	12,00
	Suhomontažna zaključna letva Završna letva u sistemu suhe montaže	karton 25 kosov / karton 25 komada (Cena za kos / Cijena na komad 32,00 EUR)	3838987 903116	800,00
	Chromoterapia (CTL) Chromoterapia (CTL)	2 LED lučki s samostalno tipkovnicom 2 LED svjetla sa samostalnom tipkovnicom		401,00
	Dve dodatni mikro šobi Dvije dodatne mikro mlaznice	za masažo stopal (kpl) za masažu stopala (kpl)		64,00
	Servisno prezračevalni pokrov z rešetko Servisno ventilacijski pokrov s rešetkom	za masažne kadi za vgradnjo (45x45 cm) za masažne kade za ugradnju (45x45 cm)	3838987 534808	95,00
	ANTI-SLIP PREMAZ	protizdrsni premaz za kopalne kadi protiv klizni premaz za kupaonske kade (min. kol. 10 kos)		70,00
	Specialno čistilo KOLPA SAN Specialno sredstvo za čišćenje	karton 20 kosov / karton 20 komada (Cena za kos / Cijena na komad 6,50 EUR)	3838987 747291	130,00
	Specialno čistilo ECO SAN Specialno sredstvo za čišćenje	karton 20 kosov / karton 20 komada (Cena za kos / Cijena na komad 5,70 EUR)	3838987 572220	114,00
	Čistilo za masažne sisteme Sredstvo za čišćenje masažnih sistema	karton 10 kosov / karton 10 komada (Cena za kos / Cijena na komad 8,20 EUR)	3838987 747277	82,00



Kopalne in masažne kadi

Kade za kupanje i masažne kade

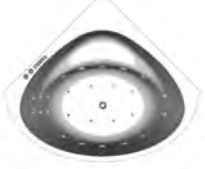
Program:**kolpa·san**
BY KOLPA





Model	Naziv in dimenzija izdelka Naziv i dimenzije produkta	Opis Opis	EAN koda EAN koda	Cena EUR Cijena EUR
Dolores 140x140				
	Dolores 140x140	kopalna kad za vgradnjo kada za ugradnju	3838987 565284	422,00
	Obloga Dolores 140	obloga za kopalno kad obloga za kupaonsku kadu	3838987 565291	245,00
	CKM 120-150	podnožje kopalne kadi za oblogo podnožje kupaonske kade za oblogu	3838987 573043	167,00
	Vodni masažni sistem I. Vodeni masažni sistem I. PNEVMATSKI Dolores 140x140	z oblogo s oblogom z oblogo + mikrošobe s oblogom + mikromlaznice	3838987 927563 3838987 927570	1.847,00 2.413,00
	Kombinirani (vodni in zračni) masažni sistem / Kombinirani (vodeni i zračni) masažni sistem ELEKTRONSKI Dolores 140x140	z oblogo s oblogom z oblogo + mikrošobe s oblogom + mikromlaznice	3838987 927587 3838987 927594	3.063,00 3.629,00
	Vital masažni sistem Vital masažni sistem ELEKTRONSKI Dolores 140x140	z oblogo + mikrošobe s oblogom + mikromlaznice	3838987 927600	4.654,00
Vgradnja mikrošob v kad Ugradnja mikromlaznica u kadu Dolores 140x140				
	Prikaz vgradnje mikrošob Prikaz ugradnje mikromlaznica Dolores 140x140			

Kopalne in masažne kadi

Kade za kupanje i masažne kade

Program:

kolpa·san
BY KOLPA

Model	Naziv in dimenzija izdelka Naziv i dimenzije produkta	Opis Opis	EAN koda EAN koda	Cena EUR Cijena EUR
Dodatki za / Dodaci za Dolores 140x140				
	GEYSER 	enoročna arm. s tuš ročico in polnilno /odlivno prelivno gar. za polnjenje kadi jednoručna arm. s tuš ručicom i priljev/odljev prelivnom garnituroom za punjenje kada	3838987 506287	633,00
	RAINDROP 	enoročna armatura s tuš ročico in izlivom / jednoručna armatura s tuš ručicom i izljevom	3838987 726500	620,00
	UP&DOWN, WHITE	prelivna garnitura s sifonom, bela preljevna garnitura sa sifonom, bijela	3838987 922759	65,00
	PAL 650, CHR	prelivna garnitura s sifonom, krom preljevna garnitura sa sifonom, krom	3838987 746270	58,00
	HEADREST SOFT	vzglavnik naslon za glavu	3838987 593942	83,00
	HEADREST COAST	vzglavnik naslon za glavu	3838987 593928	108,00
	1001/B	podnožje kopalne kadi za vgradnjo podnožje kupaonske kade za ugradnju	3838987 876502	51,00
	Zidni montažni set Zidni montažni set	za kopalne in tuš kadi za vgradnjo za kupaonske i tuš kade za ugradnju	3838987 704362	12,00
	Suhomontažna zaključna letva Završna letva u sistemu suhe montaže	karton 25 kosov / karton 25 komada (Cena za kos / Cijena na komad 32,00 EUR)	3838987 903116	800,00
	Chromotherapy (CTL) Chromotherapy (CTL)	2 LED lučki s samostojno tipkovnicom 2 LED svjetla sa samostalnom tipkovnicom		401,00
	Dve dodatni mikro šobi Dvije dodatne mikro mlaznice	za masažo stopal (kpl) za masažu stopala (kpl)		64,00
	Servisno prezračevalni pokrov z rešetko Servisno ventilacijski pokrov s rešetkom	za masažne kadi za vgradnjo (45x45 cm) za masažne kade za ugradnju (45x45 cm)	3838987 534808	95,00
	ANTI-SLIP PREMAZ	protizdrsni premaz za kopalne kadi protiv klizni premaz za kupaonske kade (min. kol. 10 kos)		70,00
	Specialno čistilo KOLPA SAN Specialno sredstvo za čišćenje	karton 20 kosov / karton 20 komada (Cena za kos / Cijena na komad 6,50 EUR)	3838987 747291	130,00
	Specialno čistilo ECO SAN Specialno sredstvo za čišćenje	karton 20 kosov / karton 20 komada (Cena za kos / Cijena na komad 5,70 EUR)	3838987 572220	114,00
	Čistilo za masažne sisteme Sredstvo za čišćenje masažnih sistema	karton 10 kosov / karton 10 komada (Cena za kos / Cijena na komad 8,20 EUR)	3838987 747277	82,00



Kopalne in masažne kadi
Kade za kupanje i masažne kade



Kopalne in masažne kadi

Kade za kupanje i masažne kade













Program:**kolpa·san**
by KOLPA

Model	Naziv in dimenzija izdelka Naziv i dimenzije produkta	Opis Opis	EAN koda EAN koda	Cena EUR Cijena EUR
Dolores 130x130				
	Dolores 130x130	kopalna kad za vgradnjo kada za ugradnju	3838987 565482	360,00
	Obloga Dolores 130	obloga za kopalno kad obloga za kupaonsku kadu	3838987 565499	209,00
	CKM 120-150	podnožje kopalne kadi za oblogo podnožje kupaonske kade za oblogu	3838987 573043	167,00

Kopalne in masažne kadi

Kade za kupanje i masažne kade

Program:**kolpa·san**
BY KOLPA

Model	Naziv in dimenzija izdelka Naziv i dimenzije produkta	Opis Opis	EAN koda EAN koda	Cena EUR Cijena EUR
Dodatki za / Dodaci za Dolores 130x130				
	GEYSER 	enoročna arm. s tuš ročico in polnilno /odlivno prelivno gar. za polnjenje kadi jednoročna arm. s tuš ručicom i priljev/odljev prelivnom garniturom za punjenje kada	3838987 506287	633,00
	RAINDROP 	enoročna armatura s tuš ročico in izlivom / jednoročna armatura s tuš ručicom i izljevom	3838987 726500	620,00
	UP&DOWN, WHITE	prelivna garnitura s sifonom, bela preljevna garnitura sa sifonom, bijela	3838987 922759	65,00
	PAL 650, CHR	prelivna garnitura s sifonom, krom preljevna garnitura sa sifonom, krom	3838987 746270	58,00
	HEADREST SOFT	vzglavnik naslon za glavu	3838987 593942	83,00
	HEADREST COAST	vzglavnik naslon za glavu	3838987 593928	108,00
	1001/B	podnožje kopalne kadi za vgradnjo podnožje kupaonske kade za ugradnju	3838987 876502	51,00
	Zidni montažni set Zidni montažni set	za kopalne in tuš kadi za vgradnjo za kupaonske i tuš kade za ugradnju	3838987 704362	12,00
	Suhomontažna zaključna letev Završna letva u sistemu suhe montaže	karton 25 kosov / karton 25 komada (Cena za kos / Cijena na komad 32,00 EUR)	3838987 903116	800,00
	Servisno prezračevalni pokrov z rešetko Servisno ventilacijski pokrov s rešetkom	za masažne kadi za vgradnjo (45x45 cm) za masažne kade za ugradnju (45x45 cm)	3838987 534808	95,00
	ANTI-SLIP PREMAZ	protizdrski premaz za kopalne kadi protiv klizni premaz za kupaonske kade (min. kol. 10 kos)		70,00
	Specialno čištilo KOLPA SAN Specialno sredstvo za čišćenje	karton 20 kosov / karton 20 komada (Cena za kos / Cijena na komad 6,50 EUR)	3838987 747291	130,00
	Specialno čištilo ECO SAN Specialno sredstvo za čišćenje	karton 20 kosov / karton 20 komada (Cena za kos / Cijena na komad 5,70 EUR)	3838987 572220	114,00



Kopalne in masažne kadi

Kade za kupanje i masažne kade

Program:**kolpa·san**
BY KOLPA















Model	Naziv in dimenzija izdelka Naziv i dimenzije produkta	Opis Opis	EAN koda EAN koda	Cena EUR Cijena EUR
Divante 140x140				
	Divante 140x140	kopalna kad za vgradnjo kada za ugradnju	3838987 753704	264,00
	Obloga Divante 140	obloga za kopalno kad obloga za kupaonsku kadu	3838987 754022	109,00
	CD 140	podnožje kopalne kadi za oblogo podnožje kupaonske kade za oblogu	3838987 760115	139,00
	Vodni masažni sistem I. Vodeni masažni sistem I. PNEVMATSKI Divante 140x140	z oblogo / s oblogom	3838987 590743	1.085,00

Kopalne in masažne kadi

Kade za kupanje i masažne kade

Program:

kolpa·san
BY KOLPA

Model	Naziv in dimenzija izdelka Naziv i dimenzije produkta	Opis Opis	EAN koda EAN koda	Cena EUR Cijena EUR
Dodatki za / Dodaci za Divante 140x140				
	WATERFALL 	enoročna armatura s tuš ročico in izlivom / jednoručna armatura s tuš ručicom i izljevom	3838987 734543	590,00
	GEYSER 	enoročna arm. s tuš ročico in polnilno /odlivno prelivno gar. za polnjenje kadi jednoručna arm. s tuš ručicom i priljev/odljev prelivnom garnituroom za punjenje kada	3838987 506287	633,00
	RAINDROP 	enoročna armatura s tuš ročico in izlivom / jednoručna armatura s tuš ručicom i izljevom	3838987 726500	620,00
	UP&DOWN, WHITE	prelivna garnitura s sifonom, bela prelivna garnitura sa sifonom, bijela	3838987 922759	65,00
	PAL 450, CHR	prelivna garnitura s sifonom, krom prelivna garnitura sa sifonom, krom	3838987 746263	42,00
	HEADREST SOFT	vzglavnik naslon za glavu	3838987 593942	83,00
	HEADREST COAST		3838987 593928	108,00
	1001/L	podnožje kopalne kadi za vgradnjo podnožje kupaonske kade za ugradnju	3838987 773375	51,00
	TP 102/K UNI SOLE, Silver	dvodelni krilni zaslon za kopalno kad Divante dvodijelni krilni zaslon za kupaonksu kadu Divante	3838987 514800	322,00
	TP 105 QUAT Bela		3838987 314356	165,00
	Zidni montažni set Zidni montažni set	za kopalne in tuš kadi za vgradnjo za kupaonske i tuš kade za ugradnju	3838987 704362	12,00
	Suhomontažna zaključna letva Završna letva u sistemu suhe montaže	karton 25 kosov / karton 25 komada (Cena za kos / Cijena na komad 32,00 EUR)	3838987 903116	800,00
	Servisno prezračevalni pokrov z rešetko Servisno ventilacijski pokrov s rešetkom	za masažne kadi za vgradnjo (45x45 cm) za masažne kade za ugradnju (45x45 cm)	3838987 534808	95,00
	ANTI-SLIP PREMAZ	protizdrsni premaz za kopalne kadi protiv klizni premaz za kupaonske kade (min. kol. 10 kos)		70,00
	Specialno čistoilo KOLPA SAN Specialno sredstvo za čišćenje	karton 20 kosov / karton 20 komada (Cena za kos / Cijena na komad 6,50 EUR)	3838987 747291	130,00
	Specialno čistoilo ECO SAN Specialno sredstvo za čišćenje	karton 20 kosov / karton 20 komada (Cena za kos / Cijena na komad 5,70 EUR)	3838987 572220	114,00
	Čistilo za masažne sisteme Sredstvo za čišćenje masažnih sistema	karton 10 kosov / karton 10 komada (Cena za kos / Cijena na komad 8,20 EUR)	3838987 747277	82,00



Kopalne in masažne kadi

Kade za kupanje i masažne kade











Program:**kolpa·san**
by KOLPA

Model	Naziv in dimenzija izdelka Naziv i dimenzije produkta	Opis Opis	EAN koda EAN koda	Cena EUR Cijena EUR
Royal 130x130				
	Royal 130x130	kotna kopalna kad za vgradnjo kutna kada za ugradnju	3838987 705192	324,00
	Obloga Royal 130	obloga za kopalno kad obloga za kupaonsku kadu	3838987 911906	140,00
	CKM 120-150	podnožje kopalne kadi za oblogo podnožje kupaonske kade za oblogo	3838987 573043	167,00
	Vodni masažni sistem I. Vodeni masažni sistem I. PNEVMATSKI Royal 130x130	z oblogo / s oblogom	3838987 908517	1.493,00
	Kombinirani (vodni in zračni) masažni sistem / Kombinirani (vodeni i zračni) masažni sistem ELEKTRONSKI Royal 130x130	z oblogo / s oblogom	3838987 591474	2.768,00

Kopalne in masažne kadi

Kade za kupanje i masažne kade

Program:**kolpa·san**
BY KOLPA



Model	Naziv in dimenzija izdelka Naziv i dimenzije produkta	Opis Opis	EAN koda EAN koda	Cena EUR Cijena EUR
Dodatki za / Dodaci za Royal 130x130				
	UP&DOWN, WHITE	prelivna garnitura s sifonom, bela preljevna garnitura sa sifonom, bijela	3838987 922759	65,00
	PAL 450, CHR	prelivna garnitura s sifonom, krom preljevna garnitura sa sifonom, krom	3838987 746263	42,00
	HEADREST COAST	vzglavnik naslon za glavu	3838987 593928	108,00
	1001/L	podnožje kopalne kadi za vgradnjo podnožje kupaonske kade za ugradnju	3838987 773375	51,00
	TP 102/K UNI SOLE, Silver	dvodelni krilni zaslon za kopalno kad Royal dvodijelni krilni zaslon za kupaonksu kadu Royal	3838987 514800	322,00
	TP 105 QUAT Bela		3838987 314356	165,00
	Zidni montažni set Zidni montažni set	za kopalne in tuš kadi za vgradnjo za kupaonske i tuš kade za ugradnju	3838987 704362	12,00
	Suhomontažna zaključna letva Završna letva u sistemu suhe montaže	karton 25 kosov / karton 25 komada (Cena za kos / Cijena na komad 32,00 EUR)	3838987 903116	800,00
	Chromotherapie (CTL) Chromotherapie (CTL)	2 LED lučki s samostojno tipkovnico 2 LED svjetla sa samostalnom tipkovnicom		401,00
	Dve dodatni mikro šobi Dvije dodatne mikro mlaznice	za masažo stopal (kpl) za masažu stopala (kpl)		64,00
	Servisno prezračevalni pokrov z rešetko Servisno ventilacijski pokrov s rešetkom	za masažne kadi za vgradnjo (45x45 cm) za masažne kade za ugradnju (45x45 cm)	3838987 534808	95,00
	ANTI-SLIP PREMAZ	protizdrsni premaz za kopalne kadi protiv klizni premaz za kupaonske kade (min. kol. 10 kos)		70,00
	Specialno čistilo KOLPA SAN Specialno sredstvo za čišćenje	karton 20 kosov / karton 20 komada (Cena za kos / Cijena na komad 6,50 EUR)	3838987 747291	130,00
	Specialno čistilo ECO SAN Specialno sredstvo za čišćenje	karton 20 kosov / karton 20 komada (Cena za kos / Cijena na komad 5,70 EUR)	3838987 572220	114,00
	Čistilo za masažne sisteme Sredstvo za čišćenje masažnih sistema	karton 10 kosov / karton 10 komada (Cena za kos / Cijena na komad 8,20 EUR)	3838987 747277	82,00



Kopalne in masažne kadi

Kade za kupanje i masažne kade









Program:**kolpa·san**
by KOLPA

Model	Naziv in dimenzija izdelka Naziv i dimenzije produkta	Opis Opis	EAN koda EAN koda	Cena EUR Cijena EUR
Royal 120x120				
	Royal 120x120	kotna kopalna kad za vgradnjo kutna kada za ugradnju	3838987 731184	316,00
	Obloga Royal 120	obloga za kopalno kad obloga za kupaonsku kadu	3838987 739142	140,00
	CKM 120-150	podnožje kopalne kadi za oblogo podnožje kupaonske kade za oblogu	3838987 573043	167,00







Kopalne in masažne kadi

Kade za kupanje i masažne kade

Program:**kolpa·san**
BY KOLPA

Model	Naziv in dimenzija izdelka Naziv i dimenzije produkta	Opis Opis	EAN koda EAN koda	Cena EUR Cijena EUR
Dodatki za / Dodaci za Royal 120x120				
	UP&DOWN, WHITE	prelivna garnitura s sifonom, bela preljevna garnitura sa sifonom, bijela	3838987 922759	65,00
	PAL 450, CHR	prelivna garnitura s sifonom, krom preljevna garnitura sa sifonom, krom	3838987 746263	42,00
	HEADREST COAST	vzglavnik naslon za glavu	3838987 593928	108,00
	1001/L	podnožje kopalne kadi za vgradnjo podnožje kupaonske kade za ugradnju	3838987 773375	51,00
	TP 102/K UNI SOLE, Silver	dvodelni krilni zaslon za kopalno kad Royal dvodijelni krilni zaslon za kupaonksu kadu Royal	3838987 514800	322,00
	TP 105 QUAT Bela		3838987 314356	165,00
	Zidni montažni set Zidni montažni set	za kopalne in tuš kadi za vgradnjo za kupaonske i tuš kade za ugradnju	3838987 704362	12,00
	Suhomontažna zaključna letva Završna letva u sistemu suhe montaže	karton 25 kosov / karton 25 komada (Cena za kos / Cijena na komad 32,00 EUR)	3838987 903116	800,00
	Servisno prezračevalni pokrov z rešetko Servisno ventilacijski pokrov s rešetkom	za masažne kadi za vgradnjo (45x45 cm) za masažne kade za ugradnju (45x45 cm)	3838987 534808	95,00
	ANTI-SLIP PREMAZ	protizdrsni premaz za kopalne kadi protiv klizni premaz za kupaonske kade (min. kol. 10 kos)		70,00
	Specialno čistilo KOLPA SAN Specialno sredstvo za čišćenje	karton 20 kosov / karton 20 komada (Cena za kos / Cijena na komad 6,50 EUR)	3838987 747291	130,00
	Specialno čistilo ECO SAN Specialno sredstvo za čišćenje	karton 20 kosov / karton 20 komada (Cena za kos / Cijena na komad 5,70 EUR)	3838987 572220	114,00









Kopalne in masažne kadi Kade za kupanje i masažne kade		Program: kolpa·san®		
Model	Naziv in dimenzija izdelka Naziv i dimenzije produkta	Opis Opis	EAN koda EAN koda	Cena EUR Cijena EUR
Elektra-SP-L 185, 175				
	Elektra-SP-L 185x85	kopalna kad s prelivno garnituro - kad in obloga iz enega dela kada s prelivnom garniturom - kada i obloga su iz jednog dijela	3838987 513476	1.256,00
	Elektra-SP-L 175x75	kopalna kad s prelivno garnituro - kad in obloga iz enega dela kada s prelivnom garniturom - kada i obloga su iz jednog dijela	3838987 513506	1.216,00
Dodatki za / Dodaci za Elektra-SP-L 185, 175				
	HEADREST SOFT	vzglavnik naslon za glavu	3838987 593942	83,00
	HEADREST COAST		3838987 593928	108,00
	Suhomontažna zaključna letev Završna letva u sistemu suhe montaže	karton 25 kosov / karton 25 komada (Cena za kos / Cijena na komad 32,00 EUR)	3838987 903116	800,00
	ANTI-SLIP PREMAZ	protizdrsni premaz za kopalne kadi protiv klizni premaz za kupaonske kade (min. kol. 10 kos)		70,00
	Specialno čištilo KOLPA SAN Specialno sredstvo za čišćenje Specialno čištilo ECO SAN Specialno sredstvo za čišćenje	karton 20 kosov / karton 20 komada (Cena za kos / Cijena na komad 6,50 EUR) karton 20 kosov / karton 20 komada (Cena za kos / Cijena na komad 5,70 EUR)	3838987 747291 3838987 572220	130,00 114,00















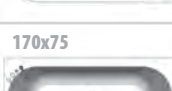

Kopalne in masažne kadi

Kade za kupanje i masažne kade

Program:**kolpa·san**
BY KOLPA

Model	Naziv in dimenzija izdelka Naziv i dimenzije produkta	Opis Opis	EAN koda EAN koda	Cena EUR Cijena EUR
Elektra-SP-D 185, 175				
	Elektra-SP-D 185x85	kopalna kad s prelivno garnituro - kad in obloga iz enega dela kada s preljevnom garniturom - kada i obloga su iz jednog dijela	3838987 513483	1.256,00
	Elektra-SP-D 175x75	kopalna kad s prelivno garnituro - kad in obloga iz enega dela kada s preljevnom garniturom - kada i obloga su iz jednog dijela	3838987 513513	1.216,00
Dodatki za / Dodaci za Elektra-SP-D 185, 175				
	HEADREST SOFT	vzglavnik naslon za glavu	3838987 593942	83,00
	HEADREST COAST		3838987 593928	108,00
	Suhomontažna zaključna letev Završna letva u sistemu suhe montaže	karton 25 kosov / karton 25 komada (Cena za kos / Cijena na komad 32,00 EUR)	3838987 903116	800,00
	ANTI-SLIP PREMAZ	protizdrsni premaz za kopalne kadi protiv klizni premaz za kupaonske kade (min. kol. 10 kos)		70,00
	Specialno čištilo KOLPA SAN Specialno sredstvo za čišćenje	karton 20 kosov / karton 20 komada (Cena za kos / Cijena na komad 6,50 EUR)	3838987 747291	130,00
	Specialno čištilo ECO SAN Specialno sredstvo za čišćenje	karton 20 kosov / karton 20 komada (Cena za kos / Cijena na komad 5,70 EUR)	3838987 572220	114,00



















Kopalne in masažne kadi Kade za kupanje i masažne kade		Program: kolpa·san®		
Model	Naziv in dimenzija izdelka Naziv i dimenzije produkta	Opis Opis	EAN koda EAN koda	Cena EUR Cijena EUR
Dream-SP-L 180, 170				
	Dream-SP-L 180x80	kopalna kad s prelivno garnituro - kad in obloga iz enega dela kada s preljevnom garniturom - kada i obloga su iz jednog dijela	3838987 574361	1.137,00
	Dream-SP-L 170x75	kopalna kad s prelivno garnituro - kad in obloga iz enega dela kada s preljevnom garniturom - kada i obloga su iz jednog dijela	3838987 518037	1.086,00
Dodatki za / Dodaci za				
Dream-SP-L 180, 170				
 	180x80 170x75	WATERFALL 	enoročna armatura s tuš ročico in izlivom / jednoručna armatura s tuš ručicom i izljevom	3838987 734543 590,00
 	180x80 170x75	GEYSER 	enoročna arm. s tuš ročico in polnilno /odlivno prelivno gar. za polnjenje kadi jednoručna arm. s tuš ručicom i priljev/odljev preljevnom garniturom za punjenje kada	3838987 506287 633,00
 	180x80 170x75	RAINDROP 	enoročna armatura s tuš ročico in izlivom / jednoručna armatura s tuš ručicom i izljevom	3838987 726500 620,00
 		HEADREST SOFT HEADREST COAST	vzglavnik naslon za glavu	3838987 593942 83,00
		Suhomontažna zaključna letva Završna letva u sistemu suhe montaže	karton 25 kosov / karton 25 komada (Cena za kos / Cijena na komad 32,00 EUR)	3838987 903116 800,00
		Chromotherapia (CTL) Chromotherapia (CTL)	2 LED lučki s samostojno tipkovnico 2 LED svjetla sa samostalnom tipkovnicom	401,00
		ANTI-SLIP PREMAZ	protizdrsni premaz za kopalne kadi protiv klizni premaz za kupaonske kade (min. kol. 10 kos)	70,00
		Specialno čištilo KOLPA SAN Specialno sredstvo za čišćenje Specialno čištilo ECO SAN Specialno sredstvo za čišćenje	karton 20 kosov / karton 20 komada (Cena za kos / Cijena na komad 6,50 EUR) karton 20 kosov / karton 20 komada (Cena za kos / Cijena na komad 5,70 EUR)	130,00 114,00

Kopalne in masažne kadi

Kade za kupanje i masažne kade

Program:

kolpa·san
BY KOLPA







Model	Naziv in dimenzija izdelka Naziv i dimenzije produkta	Opis Opis	EAN koda EAN koda	Cena EUR Cijena EUR	
Dream-SP-D 180, 170					
	Dream-SP-D 180x80	kopalna kad s prelivno garnituro - kad in obloga iz enega dela kada s preljevnom garniturom - kada i obloga su iz jednog dijela	3838987 574378	1.137,00	
	Dream-SP-D 170x75	kopalna kad s prelivno garnituro - kad in obloga iz enega dela kada s preljevnom garniturom - kada i obloga su iz jednog dijela	3838987 518044	1.086,00	
Dodatki za / Dodaci za Dream-SP-D 180, 170					
<div style="display: flex; justify-content: space-around;"> <div style="text-align: center;"> <p>180x80</p>  </div> <div style="text-align: center;"> <p>170x75</p>  </div> </div>	WATERFALL		enoročna armatura s tuš ročico in izlivom / jednoručna armatura s tuš ručicom i izljevom	3838987 734543	590,00
<div style="display: flex; justify-content: space-around;"> <div style="text-align: center;"> <p>180x80</p>  </div> <div style="text-align: center;"> <p>170x75</p>  </div> </div>	GEYSER		enoročna arm. s tuš ročico in polnilno /odlivno prelivno gar. za polnjenje kadi jednoručna arm. s tuš ručicom i priljev/odljev preljevnom garniturom za punjenje kada	3838987 506287	633,00
<div style="display: flex; justify-content: space-around;"> <div style="text-align: center;"> <p>180x80</p>  </div> <div style="text-align: center;"> <p>170x75</p>  </div> </div>	RAINDROP		enoročna armatura s tuš ročico in izlivom / jednoručna armatura s tuš ručicom i izljevom	3838987 726500	620,00
	HEADREST SOFT		vzglavnik naslon za glavu	3838987 593942	83,00
	HEADREST COAST			3838987 593928	108,00
	Suhomontažna zaključna letva Završna letva u sistemu suhe montaže		karton 25 kosov / karton 25 komada (Cena za kos / Cijena na komad 32,00 EUR)	3838987 903116	800,00
	Chromoterapia (CTL) Chromoterapia (CTL)		2 LED lučki s samostojno tipkovnicom 2 LED svjetla sa samostalnom tipkovnicom		401,00
	ANTI-SLIP PREMAZ		protizdrsni premaz za kopalne kadi protiv klizni premaz za kupaonske kade (min. kol. 10 kos)		70,00
	Specialno čištilo KOLPA SAN Specialno sredstvo za čišćenje Specialno čištilo ECO SAN Specialno sredstvo za čišćenje		karton 20 kosov / karton 20 komada (Cena za kos / Cijena na komad 6,50 EUR) karton 20 kosov / karton 20 komada (Cena za kos / Cijena na komad 5,70 EUR)	3838987 747291 3838987 572220	130,00 114,00



Kopalne in masažne kadi

Kade za kupanje i masažne kade

















Program:**kolpa·san**
BY KOLPA

Model	Naziv in dimenzija izdelka Naziv i dimenzije produkta	Opis Opis	EAN koda EAN koda	Cena EUR Cijena EUR
Libretto-L 170x110				
	Libretto-L 170x110	kopalna kad za vgradnjo kada za ugradnju	3838987 565246	334,00
	Obloga Libretto 170 - L	obloga za kopalno kad - leva obloga za kupaonsku kadu - lijeva	3838987 565260	190,00
	CKM 120-150	podnožje kopalne kadi za oblogo podnožje kupaonske kade za oblogu	3838987 573043	167,00
	Vodni masažni sistem I. Vodeni masažni sistem I. PNEVMATSKI Libretto-L 170x110	z oblogo s oblogom z oblogo + mikrošobe s oblogom + mikromlaznice	3838987 927457 3838987 927464	1.463,00 2.029,00
	Kombinirani (vodni in zračni) masažni sistem / Kombinirani (vodeni i zračni) masažni sistem ELEKTRONSKI Libretto-L 170x110	z oblogo s oblogom z oblogo + mikrošobe s oblogom + mikromlaznice	3838987 927471 3838987 927488	2.742,00 3.308,00
	Vital masažni sistem Vital masažni sistem ELEKTRONSKI Libretto-L 170x110	z oblogo + mikrošobe s oblogom + mikromlaznice	3838987 927495	4.371,00
Vgradnja mikrošob v kad Ugradnja mikromlaznica u kadu Libretto-L 170x110				
	Prikaz vgradnje mikrošob Prikaz ugradnje mikromlaznica Libretto-L 170x110			

Kopalne in masažne kadi
Kade za kupanje i masažne kade

Program:

kolpa·san
BY KOLPA

Model	Naziv in dimenzija izdelka Naziv i dimenzije produkta	Opis Opis	EAN koda EAN koda	Cena EUR Cijena EUR
Dodatki za / Dodaci za Libretto-L 170x110				
	WATERFALL 	enoročna armatura s tuš ročico in izlivom / jednoručna armatura s tuš ručicom i izljevom	3838987 734543	590,00
	GEYSER 	enoročna arm. s tuš ročico in polnilno /odlivno prelivno gar. za polnjenje kadi jednoručna arm. s tuš ručicom i priljev/odljev prelivnom garniturom za punjenje kade	3838987 506287	633,00
	RAINDROP 	enoročna armatura s tuš ročico in izlivom / jednoručna armatura s tuš ručicom i izljevom	3838987 726500	620,00
	UP&DOWN, WHITE	prelivna garnitura s sifonom, bela prelivna garnitura sa sifonom, bijela	3838987 922759	65,00
	PAL 650, CHR	prelivna garnitura s sifonom, krom prelivna garnitura sa sifonom, krom	3838987 746270	58,00
	HEADREST SOFT	vzglavnik naslon za glavu	3838987 593942	83,00
	HEADREST COAST	vzglavnik naslon za glavu	3838987 593928	108,00
	PKK 501	podnožje kopalne kadi za vgradnjo podnožje kupaonske kade za ugradnju	3838987 764878	29,00
	Zidni montažni set Zidni montažni set	za kopalne in tuš kadi za vgradnjo za kupaonske i tuš kade za ugradnju	3838987 704362	12,00
	Suhomontažna zaključna letev Završna letva u sistemu suhe montaže	karton 25 kosov / karton 25 komada (Cena za kos / Cijena na komad 32,00 EUR)	3838987 903116	800,00
	Chromoterapia (CTL) Chromoterapia (CTL)	2 LED lučki s samostojno tipkovnico 2 LED svjetla sa samostalnom tipkovnicom		401,00
	Dve dodatni mikro šobi Dvije dodatne mikro mlaznice	za masažo stopal (kpl) za masažu stopala (kpl)		64,00
	Servisno prezračevalni pokrov z rešetko Servisno ventilacijski pokrov s rešetkom	za masažne kadi za vgradnjo (45x45 cm) za masažne kade za ugradnju (45x45 cm)	3838987 534808	95,00
	ANTI-SLIP PREMAZ	protizdrsni premaz za kopalne kadi protiv klizni premaz za kupaonske kade (min. kol. 10 kos)		70,00
	Specialno čištilo KOLPA SAN Specialno sredstvo za čišćenje	karton 20 kosov / karton 20 komada (Cena za kos / Cijena na komad 6,50 EUR)	3838987 747291	130,00
	Specialno čištilo ECO SAN Specialno sredstvo za čišćenje	karton 20 kosov / karton 20 komada (Cena za kos / Cijena na komad 5,70 EUR)	3838987 572220	114,00
	Čistilo za masažne sisteme Sredstvo za čišćenje masažnih sistema	karton 10 kosov / karton 10 komada (Cena za kos / Cijena na komad 8,20 EUR)	3838987 747277	82,00



Kopalne in masažne kadi
Kade za kupanje i masažne kade

Program:

kolpa·san
BY KOLPA

















Model	Naziv in dimenzija izdelka Naziv i dimenzije produkta	Opis Opis	EAN koda EAN koda	Cena EUR Cijena EUR
Libretto-D 170x110				
	Libretto-D 170x110	kopalna kad za vgradnjo kada za ugradnju	3838987 565253	334,00
	Obloga Libretto 170 -D	obloga za kopalno kad - desna obloga za kupaonsku kadu - desna	3838987 565277	190,00
	CKM 120-150	podnožje kopalne kadi za oblogo podnožje kupaonske kade za oblogu	3838987 573043	167,00
	Vodni masažni sistem I. Vodeni masažni sistem I. PNEVMATSKI Libretto-D 170x110	z oblogo s oblogom z oblogo + mikrošobe s oblogom + mikromlaznice	3838987 927501 3838987 927518	1.463,00 2.029,00
	Kombinirani (vodni in zračni) masažni sistem / Kombinirani (vodeni i zračni) masažni sistem ELEKTRONSKI Libretto-D 170x110	z oblogo s oblogom z oblogo + mikrošobe s oblogom + mikromlaznice	3838987 927525 3838987 927532	2.742,00 3.308,00
	Vital masažni sistem Vital masažni sistem ELEKTRONSKI Libretto-D 170x110	z oblogo + mikrošobe s oblogom + mikromlaznice	3838987 927549	4.371,00
Vgradnja mikrošob v kad Ugradnja mikromlaznica u kadu Libretto-D 170x110				
	Prikaz vgradnje mikrošob Prikaz ugradnje mikromlaznica Libretto-D 170x110			

Kopalne in masažne kadi

Kade za kupanje i masažne kade

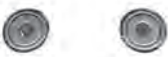
Program:

kolpa·san
BY KOLPA







Model	Naziv in dimenzija izdelka Naziv i dimenzije produkta	Opis Opis	EAN koda EAN koda	Cena EUR Cijena EUR
Dodatki za / Dodaci za Libretto-D 170x110				
	WATERFALL 	enoročna armatura s tuš ročico in izlivom / jednoručna armatura s tuš ručicom i izljevom	3838987 734543	590,00
	GEYSER 	enoročna arm. s tuš ročico in polnilno /odlivno prelivno gar. za polnjenje kadi jednoručna arm. s tuš ručicom i priljev/odljev prelivnom garniturom za punjenje kade	3838987 506287	633,00
	RAINDROP 	enoročna armatura s tuš ročico in izlivom / jednoručna armatura s tuš ručicom i izljevom	3838987 726500	620,00
	UP&DOWN, WHITE	prelivna garnitura s sifonom, bela prelivna garnitura sa sifonom, bijela	3838987 922759	65,00
	PAL 650, CHR	prelivna garnitura s sifonom, krom prelivna garnitura sa sifonom, krom	3838987 746270	58,00
	HEADREST SOFT	vzglavnik naslon za glavu	3838987 593942	83,00
	HEADREST COAST	vzglavnik naslon za glavu	3838987 593928	108,00
	PKK 501	podnožje kopalne kadi za vgradnjo podnožje kupaonske kade za ugradnju	3838987 764878	29,00
	Zidni montažni set Zidni montažni set	za kopalne in tuš kadi za vgradnjo za kupaonske i tuš kade za ugradnju	3838987 704362	12,00
	Suhomontažna zaključna letev Završna letva u sistemu suhe montaže	karton 25 kosov / karton 25 komada (Cena za kos / Cijena na komad 32,00 EUR)	3838987 903116	800,00
	Chromoterapia (CTL) Chromoterapia (CTL)	2 LED lučki s samostojno tipkovnico 2 LED svjetla sa samostalnom tipkovnicom		401,00
	Dve dodatni mikro šobi Dvije dodatne mikro mlaznice	za masažo stopal (kpl) za masažu stopala (kpl)		64,00
	Servisno prezračevalni pokrov z rešetko Servisno ventilacijski pokrov s rešetkom	za masažne kadi za vgradnjo (45x45 cm) za masažne kade za ugradnju (45x45 cm)	3838987 534808	95,00
	ANTI-SLIP PREMAZ	protizdrsni premaz za kopalne kadi protiv klizni premaz za kupaonske kade (min. kol. 10 kos)		70,00
	Specialno čistoilo KOLPA SAN Specialno sredstvo za čišćenje	karton 20 kosov / karton 20 komada (Cena za kos / Cijena na komad 6,50 EUR)	3838987 747291	130,00
	Specialno čistoilo ECO SAN Specialno sredstvo za čišćenje	karton 20 kosov / karton 20 komada (Cena za kos / Cijena na komad 5,70 EUR)	3838987 572220	114,00
	Čistilo za masažne sisteme Sredstvo za čišćenje masažnih sistema	karton 10 kosov / karton 10 komada (Cena za kos / Cijena na komad 8,20 EUR)	3838987 747277	82,00



Kopalne in masažne kadi

Kade za kupanje i masažne kade

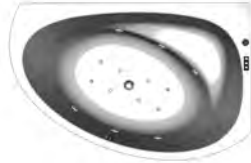
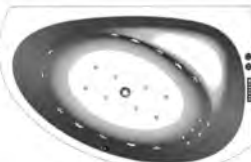
Program:**kolpa·san**
BY KOLPA

















Model	Naziv in dimenzija izdelka Naziv i dimenzije produkta	Opis Opis	EAN koda EAN koda	Cena EUR Cijena EUR
Libretto-L 160x100				
	Libretto-L 160x100	kopalna kad za vgradnjo kada za ugradnju	3838987 574736	319,00
	Obloga Libretto 160 - L	obloga za kopalno kad - leva obloga za kupaonsku kadu - lijeva	3838987 565581	183,00
	CKM 120-150	podnožje kopalne kadi za oblogo podnožje kupaonske kade za oblogu	3838987 573043	167,00
	Vodni masažni sistem I. Vodeni masažni sistem I. PNEVMATSKI Libretto-L 160x100	z oblogo s oblogom z oblogo + mikrošobe s oblogom + mikromlaznice	3838987 927358 3838987 927365	1.449,00 2.016,00
	Kombinirani (vodni in zračni) masažni sistem / Kombinirani (vodeni i zračni) masažni sistem ELEKTRONSKI Libretto-L 160x100	z oblogo s oblogom z oblogo + mikrošobe s oblogom + mikromlaznice	3838987 927372 3838987 927389	2.728,00 3.294,00
	Vital masažni sistem Vital masažni sistem ELEKTRONSKI Libretto-L 160x100	z oblogo + mikrošobe s oblogom + mikromlaznice	3838987 927396	4.359,00
Vgradnja mikrošob v kad Ugradnja mikromlaznica u kadu Libretto-L 160x100				
	Prikaz vgradnje mikrošob Prikaz ugradnje mikromlaznica Libretto-L 160x100			

Kopalne in masažne kadi

Kade za kupanje i masažne kade

Program:

kolpa·san
BY KOLPA

Model	Naziv in dimenzija izdelka Naziv i dimenzije produkta	Opis Opis	EAN koda EAN koda	Cena EUR Cijena EUR
Dodatki za / Dodaci za Libretto-L 160x100				
	WATERFALL 	enoročna armatura s tuš ročico in izlivom / jednoručna armatura s tuš ručicom i izljevom	3838987 734543	590,00
	GEYSER 	enoročna arm. s tuš ročico in polnilno /odlivno prelivno gar. za polnjenje kadi jednoručna arm. s tuš ručicom i priljev/odljev prelivnom garniturom za punjenje kade	3838987 506287	633,00
	RAINDROP 	enoročna armatura s tuš ročico in izlivom / jednoručna armatura s tuš ručicom i izljevom	3838987 726500	620,00
	UP&DOWN, WHITE	prelivna garnitura s sifonom, bela prelivna garnitura sa sifonom, bijela	3838987 922759	65,00
	PAL 650, CHR	prelivna garnitura s sifonom, krom prelivna garnitura sa sifonom, krom	3838987 746270	58,00
	HEADREST SOFT	vzglavnik naslon za glavu	3838987 593942	83,00
	HEADREST COAST	vzglavnik naslon za glavu	3838987 593928	108,00
	PKK 501	podnožje kopalne kadi za vgradnjo podnožje kupaonske kade za ugradnju	3838987 764878	29,00
	Zidni montažni set Zidni montažni set	za kopalne in tuš kadi za vgradnjo za kupaonske i tuš kade za ugradnju	3838987 704362	12,00
	Suhomontažna zaključna letev Završna letva u sistemu suhe montaže	karton 25 kosov / karton 25 komada (Cena za kos / Cijena na komad 32,00 EUR)	3838987 903116	800,00
	Chromoterapia (CTL) Chromoterapia (CTL)	2 LED lučki s samostojno tipkovnico 2 LED svjetla sa samostalnom tipkovnicom		401,00
	Dve dodatni mikro šobi Dvije dodatne mikro mlaznice	za masažo stopal (kpl) za masažu stopala (kpl)		64,00
	Servisno prezračevalni pokrov z rešetko Servisno ventilacijski pokrov s rešetkom	za masažne kadi za vgradnjo (45x45 cm) za masažne kade za ugradnju (45x45 cm)	3838987 534808	95,00
	ANTI-SLIP PREMAZ	protizdrsni premaz za kopalne kadi protiv klizni premaz za kupaonske kade (min. kol. 10 kos)		70,00
	Specialno čistilo KOLPA SAN Specialno sredstvo za čišćenje	karton 20 kosov / karton 20 komada (Cena za kos / Cijena na komad 6,50 EUR)	3838987 747291	130,00
	Specialno čistilo ECO SAN Specialno sredstvo za čišćenje	karton 20 kosov / karton 20 komada (Cena za kos / Cijena na komad 5,70 EUR)	3838987 572220	114,00
	Čistilo za masažne sisteme Sredstvo za čišćenje masažnih sistema	karton 10 kosov / karton 10 komada (Cena za kos / Cijena na komad 8,20 EUR)	3838987 747277	82,00



Kopalne in masažne kadi

Kade za kupanje i masažne kade

Program:**kolpa·san**
BY KOLPA

















Model	Naziv in dimenzija izdelka Naziv i dimenzije produkta	Opis Opis	EAN koda EAN koda	Cena EUR Cijena EUR
Libretto-D 160x100				
	Libretto-D 160x100	kopalna kad za vgradnjo kada za ugradnju	3838987 574743	319,00
	Obloga Libretto 160 -D	obloga za kopalno kad - desna obloga za kupaonsku kadu - desna	3838987 565598	183,00
	CKM 120-150	podnožje kopalne kadi za oblogo podnožje kupaonske kade za oblogu	3838987 573043	167,00
	Vodni masažni sistem I. Vodeni masažni sistem I. PNEVMATSKI Libretto-D 160x100	z oblogo s oblogom z oblogo + mikrošobe s oblogom + mikromlaznice	3838987 927402 3838987 927419	1.449,00 2.016,00
	Kombinirani (vodni in zračni) masažni sistem / Kombinirani (vodeni i zračni) masažni sistem ELEKTRONSKI Libretto-D 160x100	z oblogo s oblogom z oblogo + mikrošobe s oblogom + mikromlaznice	3838987 927426 3838987 927433	2.728,00 3.294,00
	Vital masažni sistem Vital masažni sistem ELEKTRONSKI Libretto-D 160x100	z oblogo + mikrošobe s oblogom + mikromlaznice	3838987 927440	4.359,00
Vgradnja mikrošob v kad Ugradnja mikromlaznica u kadu Libretto-D 160x100				
	Prikaz vgradnje mikrošob Prikaz ugradnje mikromlaznica Libretto-D 160x100			

Kopalne in masažne kadi

Kade za kupanje i masažne kade

Program:

kolpa·san
BY KOLPA







Model	Naziv in dimenzija izdelka Naziv i dimenzije produkta	Opis Opis	EAN koda EAN koda	Cena EUR Cijena EUR
Dodatki za / Dodaci za Libretto-D 160x100				
	WATERFALL 	enoročna armatura s tuš ročico in izlivom / jednoručna armatura s tuš ručicom i izljevom	3838987 734543	590,00
	GEYSER 	enoročna arm. s tuš ročico in polnilno /odlivno prelivno gar. za polnjenje kadi jednoručna arm. s tuš ručicom i priljev/odljev prelivnom garniturom za punjenje kade	3838987 506287	633,00
	RAINDROP 	enoročna armatura s tuš ročico in izlivom / jednoručna armatura s tuš ručicom i izljevom	3838987 726500	620,00
	UP&DOWN, WHITE	prelivna garnitura s sifonom, bela prelivna garnitura sa sifonom, bijela	3838987 922759	65,00
	PAL 650, CHR	prelivna garnitura s sifonom, krom prelivna garnitura sa sifonom, krom	3838987 746270	58,00
	HEADREST SOFT	vzglavnik naslon za glavu	3838987 593942	83,00
	HEADREST COAST	vzglavnik naslon za glavu	3838987 593928	108,00
	PKK 501	podnožje kopalne kadi za vgradnjo podnožje kupaonske kade za ugradnju	3838987 764878	29,00
	Zidni montažni set Zidni montažni set	za kopalne in tuš kadi za vgradnjo za kupaonske i tuš kade za ugradnju	3838987 704362	12,00
	Suhomontažna zaključna letev Završna letva u sistemu suhe montaže	karton 25 kosov / karton 25 komada (Cena za kos / Cijena na komad 32,00 EUR)	3838987 903116	800,00
	Chromoterapia (CTL) Chromoterapia (CTL)	2 LED lučki s samostojno tipkovnico 2 LED svjetla sa samostalnom tipkovnicom		401,00
	Dve dodatni mikro šobi Dvije dodatne mikro mlaznice	za masažo stopal (kpl) za masažu stopala (kpl)		64,00
	Servisno prezračevalni pokrov z rešetko Servisno ventilacijski pokrov s rešetkom	za masažne kadi za vgradnjo (45x45 cm) za masažne kade za ugradnju (45x45 cm)	3838987 534808	95,00
	ANTI-SLIP PREMAZ	protizdrsni premaz za kopalne kadi protiv klizni premaz za kupaonske kade (min. kol. 10 kos)		70,00
	Specialno čistilo KOLPA SAN Specialno sredstvo za čišćenje	karton 20 kosov / karton 20 komada (Cena za kos / Cijena na komad 6,50 EUR)	3838987 747291	130,00
	Specialno čistilo ECO SAN Specialno sredstvo za čišćenje	karton 20 kosov / karton 20 komada (Cena za kos / Cijena na komad 5,70 EUR)	3838987 572220	114,00
	Čistilo za masažne sisteme Sredstvo za čišćenje masažnih sistema	karton 10 kosov / karton 10 komada (Cena za kos / Cijena na komad 8,20 EUR)	3838987 747277	82,00



Kopalne in masažne kadi
Kade za kupanje i masažne kade

Program:









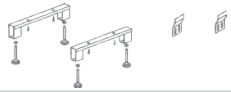

kolpa·san
BY KOLPA

Model	Naziv in dimenzija izdelka Naziv i dimenzije produkta	Opis Opis	EAN koda EAN koda	Cena EUR Cijena EUR
Beatrice-L 170x110(70)				
	Beatrice-L 170x110(70)	kopalna kad za vgradnjo kada za ugradnju - leva izvedba - lijeva varijanta	3838987 771043	331,00
	Beatrice-L 170/0	kopalna kad z oblogo kupaonska kada s oblogom - leva izvedba - lijeva varijanta	3838987 771340	752,00
	Vodni masažni sistem I. Vodeni masažni sistem I. PNEVMATSKI Beatrice-L 170x110(70)	z oblogo s oblogom z oblogo + mikrošobe s oblogom + mikromlaznice	3838987 524625 3838987 524656	1.587,00 2.153,00
	Kombinirani (vodni in zračni) masažni sistem / Kombinirani (vodeni i zračni) masažni sistem ELEKTRONSKI Beatrice-L 170x110(70)	z oblogo s oblogom z oblogo + mikrošobe s oblogom + mikromlaznice	3838987 590897 3838987 590903	2.865,00 3.430,00
	Vital masažni sistem Vital masažni sistem ELEKTRONSKI Beatrice-L 170x110(70)	z oblogo + mikrošobe s oblogom + mikromlaznice	3838987 527749	4.482,00
Vgradnja mikrošob v kad Ugradnja mikromlaznica u kado Beatrice-L 170x110(70)				
	Prikaz vgradnje mikrošob Prikaz ugradnje mikromlaznica Beatrice-L 170x110(70)			

Kopalne in masažne kadi

Kade za kupanje i masažne kade

Program:**kolpa·san**
BY KOLPA







Model	Naziv in dimenzija izdelka Naziv i dimenzije produkta	Opis Opis	EAN koda EAN koda	Cena EUR Cijena EUR
Dodatki za / Dodaci za Beatrice-L 170x110(70)				
	UP&DOWN, WHITE	prelivna garnitura s sifonom, bela prelivna garnitura sa sifonom, bijela	3838987 922759	65,00
	PAL 650, CHR	prelivna garnitura s sifonom, krom prelivna garnitura sa sifonom, krom	3838987 746270	58,00
	HEADREST SOFT	vzglavnik naslon za glavu	3838987 593942	83,00
	HEADREST COAST		3838987 593928	108,00
	1001/L	podnožje kopalne kadi za vgradnjo podnožje kupaonske kade za ugradnju	3838987 773375	51,00
	Zidni montažni set Zidni montažni set	za kopalne in tuš kadi za vgradnjo za kupaonske i tuš kade za ugradnju	3838987 704362	12,00
	Suhomontažna zaključna letva Završna letva u sistemu suhe montaže	karton 25 kosov / karton 25 komada (Cena za kos / Cijena na komad 32,00 EUR)	3838987 903116	800,00
	Chromotherapy (CTL) Chromotherapy (CTL)	2 LED lučki s samostojno tipkovnicom 2 LED svjetla sa samostalnom tipkovnicom		401,00
	Dve dodatni mikro šobi Dvije dodatne mikro mlaznice	za masažo stopal (kpl) za masažu stopala (kpl)		64,00
	Servisno prezračevalni pokrov z rešetko Servisno ventilacijski pokrov s rešetkom	za masažne kadi za vgradnjo (45x45 cm) za masažne kade za ugradnju (45x45 cm)	3838987 534808	95,00
	ANTI-SLIP PREMAZ	protizdrsni premaz za kopalne kadi protiv klizni premaz za kupaonske kade (min. kol. 10 kos)		70,00
	Specialno čistilo KOLPA SAN Specialno sredstvo za čišćenje	karton 20 kosov / karton 20 komada (Cena za kos / Cijena na komad 6,50 EUR)	3838987 747291	130,00
	Specialno čistilo ECO SAN Specialno sredstvo za čišćenje	karton 20 kosov / karton 20 komada (Cena za kos / Cijena na komad 5,70 EUR)	3838987 572220	114,00
	Čistilo za masažne sisteme Sredstvo za čišćenje masažnih sistema	karton 10 kosov / karton 10 komada (Cena za kos / Cijena na komad 8,20 EUR)	3838987 747277	82,00



Kopalne in masažne kadi

Kade za kupanje i masažne kade









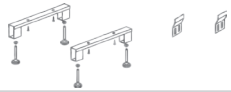

Program:**kolpa·san**
BY KOLPA

Model	Naziv in dimenzija izdelka Naziv i dimenzije produkta	Opis Opis	EAN koda EAN koda	Cena EUR Cijena EUR
Beatrice-D 170x110(70)				
	Beatrice-D 170x110(70)	kopalna kad za vgradnjo kada za ugradnju - desna izvedba - desna varijanta	3838987 771050	331,00
	Beatrice-D 170/0	kopalna kad z oblogo kupaonska kada s oblogom - desna izvedba - desna varijanta	3838987 771364	752,00
	Vodni masažni sistem I. Vodeni masažni sistem I. PNEVMATSKI Beatrice-D 170x110(70)	z oblogo s oblogom z oblogo + mikrošobe s oblogom + mikromlaznice	3838987 524762 3838987 524793	1.587,00 2.153,00
	Kombinirani (vodni in zračni) masažni sistem / Kombinirani (vodni i zračni) masažni sistem ELEKTRONSKI Beatrice-D 170x110(70)	z oblogo s oblogom z oblogo + mikrošobe s oblogom + mikromlaznice	3838987 590934 3838987 590941	2.865,00 3.430,00
	Vital masažni sistem Vital masažni sistem ELEKTRONSKI Beatrice-D 170x110(70)	z oblogo + mikrošobe s oblogom + mikromlaznice	3838987 527732	4.482,00
Vgradnja mikrošob v kad Ugradnja mikromlaznica u kado Beatrice-D 170x110(70)				
	Prikaz vgradnje mikrošob Prikaz ugradnje mikromlaznica Beatrice-D 170x110(70)			

Kopalne in masažne kadi

Kade za kupanje i masažne kade

Program:**kolpa·san**
BY KOLPA





Model	Naziv in dimenzija izdelka Naziv i dimenzije produkta	Opis Opis	EAN koda EAN koda	Cena EUR Cijena EUR
Dodatki za / Dodaci za Beatrice-D 170x110(70)				
	UP&DOWN, WHITE	prelivna garnitura s sifonom, bela preljevna garnitura sa sifonom, bijela	3838987 922759	65,00
	PAL 650, CHR	prelivna garnitura s sifonom, krom preljevna garnitura sa sifonom, krom	3838987 746270	58,00
	HEADREST SOFT	vzglavnik naslon za glavu	3838987 593942	83,00
	HEADREST COAST		3838987 593928	108,00
	1001/L	podnožje kopalne kadi za vgradnjo podnožje kupaonske kade za ugradnju	3838987 773375	51,00
	Zidni montažni set Zidni montažni set	za kopalne in tuš kadi za vgradnjo za kupaonske i tuš kade za ugradnju	3838987 704362	12,00
	Suhomontažna zaključna letva Završna letva u sistemu suhe montaže	karton 25 kosov / karton 25 komada (Cena za kos / Cijena na komad 32,00 EUR)	3838987 903116	800,00
	Chromotherapy (CTL) Chromotherapy (CTL)	2 LED lučki s samostojno tipkovnicom 2 LED svjetla sa samostalnom tipkovnicom		401,00
	Dve dodatni mikro šobi Dvije dodatne mikro mlaznice	za masažo stopal (kpl) za masažu stopala (kpl)		64,00
	Servisno prezračevalni pokrov z rešetko Servisno ventilacijski pokrov s rešetkom	za masažne kadi za vgradnjo (45x45 cm) za masažne kade za ugradnju (45x45 cm)	3838987 534808	95,00
	ANTI-SLIP PREMAZ	protizdrsni premaz za kopalne kadi protiv klizni premaz za kupaonske kade (min. kol. 10 kos)		70,00
	Specialno čistilo KOLPA SAN Specialno sredstvo za čišćenje	karton 20 kosov / karton 20 komada (Cena za kos / Cijena na komad 6,50 EUR)	3838987 747291	130,00
	Specialno čistilo ECO SAN Specialno sredstvo za čišćenje	karton 20 kosov / karton 20 komada (Cena za kos / Cijena na komad 5,70 EUR)	3838987 572220	114,00
	Čistilo za masažne sisteme Sredstvo za čišćenje masažnih sistema	karton 10 kosov / karton 10 komada (Cena za kos / Cijena na komad 8,20 EUR)	3838987 747277	82,00



Kopalne in masažne kadi

Kade za kupanje i masažne kade















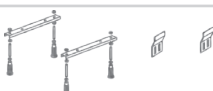

Program:**kolpa·san**
BY KOLPA

Model	Naziv in dimenzija izdelka Naziv i dimenzije produkta	Opis Opis	EAN koda EAN koda	Cena EUR Cijena EUR
Calando-L 160x90				
	Calando-L 160x90	kopalna kad za vgradnjo kada za ugradnju	3838987 570783	273,00
	Obloga Calando 160	obloga za kopalno kad obloga za kupaonsku kado	3838987 539681	128,00
	CAM 150-180	podnožje kopalne kadi za oblogo podnožje kupaonske kade za oblogo	3838987 573029	140,00
	Vodni masažni sistem I. Vodeni masažni sistem I. PNEVMATSKI Calando-L 160x90	z oblogo s oblogom	3838987 571933	1.409,00
	Kombinirani (vodni in zračni) masažni sistem / Kombinirani (vodeni i zračni) masažni sistem ELEKTRONSKI Calando-L 160x90	z oblogo s oblogom	3838987 590972	2.685,00

Kopalne in masažne kadi
Kade za kupanje i masažne kade

Program:

kolpa·san
BY KOLPA





Model	Naziv in dimenzija izdelka Naziv i dimenzije produkta	Opis Opis	EAN koda EAN koda	Cena EUR Cijena EUR
Dodatki za / Dodaci za Calando-L 160x90				
	WATERFALL 	enoročna armatura s tuš ročico in izlivom / jednoručna armatura s tuš ručicom i izljevom	3838987 734543	590,00
	GEYSER 	enoročna arm. s tuš ročico in polnilno /odlivno prelivno gar. za polnjenje kadi jednoručna arm. s tuš ručicom i priljev/odljev prelivnom garnituroom za punjenje kada	3838987 506287	633,00
	RAINDROP 	enoročna armatura s tuš ročico in izlivom / jednoručna armatura s tuš ručicom i izljevom	3838987 726500	620,00
	UP&DOWN, WHITE	prelivna garnitura s sifonom, bela prelivna garnitura sa sifonom, bijela	3838987 922759	65,00
	PAL 450, CHR	prelivna garnitura s sifonom, krom prelivna garnitura sa sifonom, krom	3838987 746263	42,00
	HEADREST SOFT	vzglavnik naslon za glavu	3838987 593942	83,00
	HEADREST COAST		3838987 593928	108,00
	PKK 501	podnožje kopalne kadi za vgradnjo podnožje kupaonske kade za ugradnju	3838987 764878	29,00
	TP 104/K UNI SOLE Silver	dvodelni krilni zaslon za kop. kad CALANDO, h=140 dvodijelni krilni zaslon za kup. kadu CALANDO, h=140	3838987 514817	324,00
	TP 108 QUAT Bela		3838987 726753	170,00
	Zidni montažni set Zidni montažni set	za kopalne in tuš kadi za vgradnjo za kupaonske i tuš kade za ugradnju	3838987 704362	12,00
	Suhomontažna zaključna letva Završna letva u sistemu suhe montaže	karton 25 kosov / karton 25 komada (Cena za kos / Cijena na komad 32,00 EUR)	3838987 903116	800,00
	Chromoterapia (CTL) Chromoterapia (CTL)	2 LED lučki s samostojno tipkovnico 2 LED svjetla sa samostalnom tipkovnicom		401,00
	Servisno prezračevalni pokrov z rešetko Servisno ventilacijski pokrov s rešetkom	za masažne kadi za vgradnjo (45x45 cm) za masažne kade za ugradnju (45x45 cm)	3838987 534808	95,00
	ANTI-SLIP PREMAZ	protizdrsni premaz za kopalne kadi protiv klizni premaz za kupaonske kade (min. kol. 10 kos)		70,00
	Specialno čistilo KOLPA SAN Specialno sredstvo za čišćenje	karton 20 kosov / karton 20 komada (Cena za kos / Cijena na komad 6,50 EUR)	3838987 747291	130,00
	Specialno čistilo ECO SAN Specialno sredstvo za čišćenje	karton 20 kosov / karton 20 komada (Cena za kos / Cijena na komad 5,70 EUR)	3838987 572220	114,00
	Čistilo za masažne sisteme Sredstvo za čišćenje masažnih sistema	karton 10 kosov / karton 10 komada (Cena za kos / Cijena na komad 8,20 EUR)	3838987 747277	82,00



Kopalne in masažne kadi

Kade za kupanje i masažne kade

















Program:**kolpa·san**
BY KOLPA

Model	Naziv in dimenzija izdelka Naziv i dimenzije produkta	Opis Opis	EAN koda EAN koda	Cena EUR Cijena EUR
Calando-D 160x90				
	Calando-D 160x90	kopalna kad za vgradnjo kada za ugradnju	3838987 570769	273,00
	Obloga Calando 160	obloga za kopalno kad obloga za kupaonsku kado	3838987 539681	128,00
	CAM 150-180	podnožje kopalne kadi za oblogo podnožje kupaonske kade za oblogo	3838987 573029	140,00
	Vodni masažni sistem I. Vodeni masažni sistem I. PNEVMATSKI Calando-D 160x90	z oblogo s oblogom	3838987 527763	1.409,00
	Kombinirani (vodni in zračni) masažni sistem / Kombinirani (vodeni i zračni) masažni sistem ELEKTRONSKI Calando-D 160x90	z oblogo s oblogom	3838987 591016	2.685,00

Kopalne in masažne kadi

Kade za kupanje i masažne kade

Program:**kolpa·san**
BY KOLPA





Model	Naziv in dimenzija izdelka Naziv i dimenzije produkta	Opis Opis	EAN koda EAN koda	Cena EUR Cijena EUR
Dodatki za / Dodaci za Calando-D 160x90				
	WATERFALL 	enoročna armatura s tuš ročico in izlivom / jednoručna armatura s tuš ručicom i izljevom	3838987 734543	590,00
	GEYSER 	enoročna arm. s tuš ročico in polnilno /odlivno prelivno gar. za polnjenje kadi jednoručna arm. s tuš ručicom i priljev/odljev preljevnom garnituroom za punjenje kada	3838987 506287	633,00
	RAINDROP 	enoročna armatura s tuš ročico in izlivom / jednoručna armatura s tuš ručicom i izljevom	3838987 726500	620,00
	UP&DOWN, WHITE	prelivna garnitura s sifonom, bela preljevna garnitura sa sifonom, bijela	3838987 922759	65,00
	PAL 450, CHR	prelivna garnitura s sifonom, krom preljevna garnitura sa sifonom, krom	3838987 746263	42,00
	HEADREST SOFT	vzglavnik naslon za glavu	3838987 593942	83,00
	HEADREST COAST		3838987 593928	108,00
	PKK 501	podnožje kopalne kadi za vgradnjo podnožje kupaonske kade za ugradnju	3838987 764878	29,00
	TP 104/K UNI SOLE Silver	dvodelni krilni zaslon za kop. kad CALANDO, h=140	3838987 514817	324,00
	TP 108 QUAT Bela	dvodijelni krilni zaslon za kup. kadu CALANDO, h=140	3838987 726753	170,00
	Zidni montažni set Zidni montažni set	za kopalne in tuš kadi za vgradnjo za kupaonske i tuš kade za ugradnju	3838987 704362	12,00
	Suhomontažna zaključna letva Završna letva u sistemu suhe montaže	karton 25 kosov / karton 25 komada (Cena za kos / Cijena na komad 32,00 EUR)	3838987 903116	800,00
	Chromoterapia (CTL) Chromoterapia (CTL)	2 LED lučki s samostojno tipkovnicom 2 LED svjetla sa samostalnom tipkovnicom		401,00
	Servisno prezračevalni pokrov z rešetko Servisno ventilacijski pokrov s rešetkom	za masažne kadi za vgradnjo (45x45 cm) za masažne kade za ugradnju (45x45 cm)	3838987 534808	95,00
	ANTI-SLIP PREMAZ	protizdrsni premaz za kopalne kadi protiv klizni premaz za kupaonske kade (min. kol. 10 kos)		70,00
	Specialno čistilo KOLPA SAN Specialno sredstvo za čišćenje	karton 20 kosov / karton 20 komada (Cena za kos / Cijena na komad 6,50 EUR)	3838987 747291	130,00
	Specialno čistilo ECO SAN Specialno sredstvo za čišćenje	karton 20 kosov / karton 20 komada (Cena za kos / Cijena na komad 5,70 EUR)	3838987 572220	114,00
	Čistilo za masažne sisteme Sredstvo za čišćenje masažnih sistema	karton 10 kosov / karton 10 komada (Cena za kos / Cijena na komad 8,20 EUR)	3838987 747277	82,00



Kopalne in masažne kadi

Kade za kupanje i masažne kade

Program:**kolpa·san**
BY KOLPA

















Model	Naziv in dimenzija izdelka Naziv i dimenzije produkta	Opis Opis	EAN koda EAN koda	Cena EUR Cijena EUR
Calando-L 150x85				
	Calando-L 150x85	kopalna kad za vgradnjo kada za ugradnju	3838987 592983	256,00
	Obloga Calando 150	obloga za kopalno kad obloga za kupaonsku kado	3838987 563198	128,00
	CAM 150-180	podnožje kopalne kadi za oblogo podnožje kupaonske kade za oblogo	3838987 573029	140,00
	Vodni masažni sistem I. Vodeni masažni sistem I. PNEVMATSKI Calando-L 150x85	z oblogo s oblogom	3838987 576884	1.392,00
	Kombinirani (vodni in zračni) masažni sistem / Kombinirani (vodeni i zračni) masažni sistem ELEKTRONSKI Calando-L 150x85	z oblogo s oblogom	3838987 576907	2.670,00

Kopalne in masažne kadi

Kade za kupanje i masažne kade

Program:

kolpa·san
BY KOLPA



Model	Naziv in dimenzija izdelka Naziv i dimenzije produkta	Opis Opis	EAN koda EAN koda	Cena EUR Cijena EUR
Dodatki za / Dodaci za Calando-L 150x85				
	WATERFALL 	enoročna armatura s tuš ročico in izlivom / jednoručna armatura s tuš ručicom i izljevom	3838987 734543	590,00
	GEYSER 	enoročna arm. s tuš ročico in polnilno /odlivno prelivno gar. za polnjenje kadi jednoručna arm. s tuš ručicom i priljev/odljev preljevnom garnituroom za punjenje kada	3838987 506287	633,00
	RAINDROP 	enoročna armatura s tuš ročico in izlivom / jednoručna armatura s tuš ručicom i izljevom	3838987 726500	620,00
	UP&DOWN, WHITE	prelivna garnitura s sifonom, bela preljevna garnitura sa sifonom, bijela	3838987 922759	65,00
	PAL 450, CHR	prelivna garnitura s sifonom, krom preljevna garnitura sa sifonom, krom	3838987 746263	42,00
	HEADREST SOFT	vzglavnik naslon za glavu	3838987 593942	83,00
	HEADREST COAST		3838987 593928	108,00
	PKK 501	podnožje kopalne kadi za vgradnjo podnožje kupaonske kade za ugradnju	3838987 764878	29,00
	TP 104/K UNI SOLE Silver	dvodelni krilni zaslon za kop. kad CALANDO, h=140 dvodijelni krilni zaslon za kup. kadu CALANDO, h=140	3838987 514817	324,00
	TP 108 QUAT Bela		3838987 726753	170,00
	Zidni montažni set Zidni montažni set	za kopalne in tuš kadi za vgradnjo za kupaonske i tuš kade za ugradnju	3838987 704362	12,00
	Suhomontažna zaključna letva Završna letva u sistemu suhe montaže	karton 25 kosov / karton 25 komada (Cena za kos / Cijena na komad 32,00 EUR)	3838987 903116	800,00
	Chromoterapia (CTL) Chromoterapia (CTL)	2 LED lučki s samostojno tipkovnicom 2 LED svjetla sa samostalnom tipkovnicom		401,00
	Servisno prezračevalni pokrov z rešetko Servisno ventilacijski pokrov s rešetkom	za masažne kadi za vgradnjo (45x45 cm) za masažne kade za ugradnju (45x45 cm)	3838987 534808	95,00
	ANTI-SLIP PREMAZ	protizdrsni premaz za kopalne kadi protiv klizni premaz za kupaonske kade (min. kol. 10 kos)		70,00
	Specialno čištilo KOLPA SAN Specialno sredstvo za čišćenje	karton 20 kosov / karton 20 komada (Cena za kos / Cijena na komad 6,50 EUR)	3838987 747291	130,00
	Specialno čištilo ECO SAN Specialno sredstvo za čišćenje	karton 20 kosov / karton 20 komada (Cena za kos / Cijena na komad 5,70 EUR)	3838987 572220	114,00
	Čištilo za masažne sisteme Sredstvo za čišćenje masažnih sistema	karton 10 kosov / karton 10 komada (Cena za kos / Cijena na komad 8,20 EUR)	3838987 747277	82,00



Kopalne in masažne kadi

Kade za kupanje i masažne kade

















Program:**kolpa·san**
BY KOLPA

Model	Naziv in dimenzija izdelka Naziv i dimenzije produkta	Opis Opis	EAN koda EAN koda	Cena EUR Cijena EUR
Calando-D 150x85				
	Calando-D 150x85	kopalna kad za vgradnjo kada za ugradnju	3838987 592976	256,00
	Obloga Calando 150	obloga za kopalno kad obloga za kupaonsku kado	3838987 563198	128,00
	CAM 150-180	podnožje kopalne kadi za oblogo podnožje kupaonske kade za oblogo	3838987 573029	140,00
	Vodni masažni sistem I. Vodeni masažni sistem I. PNEVMATSKI Calando-D 150x85	z oblogo s oblogom	3838987 576808	1.392,00
	Kombinirani (vodni in zračni) masažni sistem / Kombinirani (vodeni i zračni) masažni sistem ELEKTRONSKI Calando-D 150x85	z oblogo s oblogom	3838987 576822	2.670,00

Kopalne in masažne kadi

Kade za kupanje i masažne kade

Program:**kolpa·san**
BY KOLPA









Model	Naziv in dimenzija izdelka Naziv i dimenzije produkta	Opis Opis	EAN koda EAN koda	Cena EUR Cijena EUR
Dodatki za / Dodaci za Calando-D 150x85				
	WATERFALL 	enoročna armatura s tuš ročico in izlivom / jednoručna armatura s tuš ručicom i izljevom	3838987 734543	590,00
	GEYSER 	enoročna arm. s tuš ročico in polnilno /odlivno prelivno gar. za polnjenje kadi jednoručna arm. s tuš ručicom i priljev/odljev preljevnom garnituroom za punjenje kada	3838987 506287	633,00
	RAINDROP 	enoročna armatura s tuš ročico in izlivom / jednoručna armatura s tuš ručicom i izljevom	3838987 726500	620,00
	UP&DOWN, WHITE	prelivna garnitura s sifonom, bela preljevna garnitura sa sifonom, bijela	3838987 922759	65,00
	PAL 450, CHR	prelivna garnitura s sifonom, krom preljevna garnitura sa sifonom, krom	3838987 746263	42,00
	HEADREST SOFT	vzglavnik naslon za glavu	3838987 593942	83,00
	HEADREST COAST		3838987 593928	108,00
	PKK 501	podnožje kopalne kadi za vgradnjo podnožje kupaonske kade za ugradnju	3838987 764878	29,00
	TP 104/K UNI SOLE Silver	dvodelni krilni zaslon za kop. kad CALANDO, h=140	3838987 514817	324,00
	TP 108 QUAT Bela	dvodijelni krilni zaslon za kup. kadu CALANDO, h=140	3838987 726753	170,00
	Zidni montažni set Zidni montažni set	za kopalne in tuš kadi za vgradnjo za kupaonske i tuš kade za ugradnju	3838987 704362	12,00
	Suhomontažna zaključna letva Završna letva u sistemu suhe montaže	karton 25 kosov / karton 25 komada (Cena za kos / Cijena na komad 32,00 EUR)	3838987 903116	800,00
	Chromoterapia (CTL) Chromoterapia (CTL)	2 LED lučki s samostojno tipkovnico 2 LED svjetla sa samostalnom tipkovnicom		401,00
	Servisno prezračevalni pokrov z rešetko Servisno ventilacijski pokrov s rešetkom	za masažne kadi za vgradnjo (45x45 cm) za masažne kade za ugradnju (45x45 cm)	3838987 534808	95,00
	ANTI-SLIP PREMAZ	protizdrski premaz za kopalne kadi protiv klizni premaz za kupaonske kade (min. kol. 10 kos)		70,00
	Specialno čistilo KOLPA SAN Specialno sredstvo za čišćenje	karton 20 kosov / karton 20 komada (Cena za kos / Cijena na komad 6,50 EUR)	3838987 747291	130,00
	Specialno čistilo ECO SAN Specialno sredstvo za čišćenje	karton 20 kosov / karton 20 komada (Cena za kos / Cijena na komad 5,70 EUR)	3838987 572220	114,00
	Čistilo za masažne sisteme Sredstvo za čišćenje masažnih sistema	karton 10 kosov / karton 10 komada (Cena za kos / Cijena na komad 8,20 EUR)	3838987 747277	82,00



Kopalne in masažne kadi
Kade za kupanje i masažne kade

Program:

kolpa·san
BY KOLPA















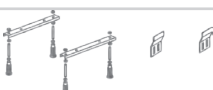

Model	Naziv in dimenzija izdelka Naziv i dimenzije produkta	Opis Opis	EAN koda EAN koda	Cena EUR Cijena EUR
Betty 200x90				
	Betty 200x90	kopalna kad za vgradnjo kada za ugradnju	3838987 565406	467,00
	A 200/63	dolga obloga duga obloga	3838987 565420	91,00
	A 90/63	kratka obloga kratka obloga	3838987 565413	58,00
	CM 180-200	podnožje kopalne kadi za oblogo podnožje kupaonske kade za oblogu	3838987 573012	125,00
	Vodni masažni sistem I. Vodeni masažni sistem I. PNEVMATSKI Betty 200x90	z oblogo s oblogom	3838987 513650	1.537,00
		z oblogo + mikrošobe s oblogom + mikromlaznice	3838987 513667	2.103,00
	Kombinirani (vodni in zračni) masažni sistem / Kombinirani (vodeni i zračni) masažni sistem ELEKTRONSKI Betty 200x90	z oblogo s oblogom	3838987 513674	2.784,00
		z oblogo + mikrošobe s oblogom + mikromlaznice	3838987 513681	3.351,00
	Vital masažni sistem Vital masažni sistem ELEKTRONSKI Betty 200x90	z oblogo + mikrošobe s oblogom + mikromlaznice	3838987 513698	4.356,00
Vgradnja mikrošob v kad Ugradnja mikromlaznica u kadu Betty 200x90				
	Prikaz vgradnje mikrošob Prikaz ugradnje mikromlaznica Betty 200x90			

Kopalne in masažne kadi

Kade za kupanje i masažne kade

Program:

kolpa·san
BY KOLPA









Model	Naziv in dimenzija izdelka Naziv i dimenzije produkta	Opis Opis	EAN koda EAN koda	Cena EUR Cijena EUR
Dodatki za / Dodaci za Betty 200x90				
	WATERFALL 	enoročna armatura s tuš ročico in izlivom / jednoručna armatura s tuš ručicom i izljevom	3838987 734543	590,00
	GEYSER 	enoročna arm. s tuš ročico in polnilno /odlivno prelivno gar. za polnjenje kadi jednoručna arm. s tuš ručicom i priljev/odljev prelivnom garniturom za punjenje kade	3838987 506287	633,00
	RAINDROP 	enoročna armatura s tuš ročico in izlivom / jednoručna armatura s tuš ručicom i izljevom	3838987 726500	620,00
	UP&DOWN, WHITE	prelivna garnitura s sifonom, bela prelivna garnitura sa sifonom, bijela	3838987 922759	65,00
	PAL 650, CHR	prelivna garnitura s sifonom, krom prelivna garnitura sa sifonom, krom	3838987 746270	58,00
	HEADREST SOFT	vzglavnik naslon za glavu	3838987 593942	83,00
	HEADREST COAST	vzglavnik naslon za glavu	3838987 593928	108,00
	PKK 501	podnožje kopalne kadi za vgradnjo podnožje kupaonske kade za ugradnju	3838987 764878	29,00
	Zidni montažni set Zidni montažni set	za kopalne in tuš kadi za vgradnjo za kupaonske i tuš kade za ugradnju	3838987 704362	12,00
	Montažni set za oblogo /magnet Montažni set za oblogo / magnet	za kopalne kadi (v primeru dodatne kratke obloge) / za kupaonske kade (u primeru dodatne kratke obloge)	3838987 590750	29,00
	Suhomontažna zaključna letev Završna letva u sistemu suhe montaže	karton 25 kosov / karton 25 komada (Cena za kos / Cijena na komad 32,00 EUR)	3838987 903116	800,00
	Chromoterapia (CTL) Chromoterapia (CTL)	2 LED lučki s samostojno tipkovnico 2 LED svjetla sa samostalnom tipkovnicom		401,00
	Dve dodatni mikro šobi Dvije dodatne mikro mlaznice	za masažo stopal (kpl) za masažu stopala (kpl)		64,00
	Servisno prezračevalni pokrov z rešetko Servisno ventilacijski pokrov s rešetkom	za masažne kadi za vgradnjo (45x45 cm) za masažne kade za ugradnju (45x45 cm)	3838987 534808	95,00
	ANTI-SLIP PREMAZ	protizdrsni premaz za kopalne kadi protiv klizni premaz za kupaonske kade (min. kol. 10 kos)		70,00
	Specialno čistilo KOLPA SAN Specialno sredstvo za čišćenje	karton 20 kosov / karton 20 komada (Cena za kos / Cijena na komad 6,50 EUR)	3838987 747291	130,00
	Specialno čistilo ECO SAN Specialno sredstvo za čišćenje	karton 20 kosov / karton 20 komada (Cena za kos / Cijena na komad 5,70 EUR)	3838987 572220	114,00
	Čistilo za masažne sisteme Sredstvo za čišćenje masažnih sistema	karton 10 kosov / karton 10 komada (Cena za kos / Cijena na komad 8,20 EUR)	3838987 747277	82,00



Kopalne in masažne kadi

Kade za kupanje i masažne kade

















Program:**kolpa·san**
BY KOLPA

Model	Naziv in dimenzija izdelka Naziv i dimenzije produkta	Opis Opis	EAN koda EAN koda	Cena EUR Cijena EUR
Betty 190x90				
	Betty 190x90	kopalna kad za vgradnjo kada za ugradnju	3838987 565451	396,00
	A 190/63	dolga obloga duga obloga	3838987 565468	91,00
	A 90/63	kratka obloga kratka obloga	3838987 565413	58,00
	CM 180-200	podnožje kopalne kadi za oblogo podnožje kupaonske kade za oblogu	3838987 573012	125,00
	Vodni masažni sistem I. Vodeni masažni sistem I. PNEVMATSKI Betty 190x90	z oblogo s oblogom z oblogo + mikrošobe s oblogom + mikromlaznice	3838987 513704 3838987 513711	1.472,00 2.038,00
	Kombinirani (vodni in zračni) masažni sistem / Kombinirani (vodeni i zračni) masažni sistem ELEKTRONSKI Betty 190x90	z oblogo s oblogom z oblogo + mikrošobe s oblogom + mikromlaznice	3838987 513728 3838987 513735	2.718,00 3.285,00
	Vital masažni sistem Vital masažni sistem ELEKTRONSKI Betty 190x90	z oblogo + mikrošobe s oblogom + mikromlaznice	3838987 513742	4.291,00
Vgradnja mikrošob v kad Ugradnja mikromlaznica u kadu Betty 190x90				
	Prikaz vgradnje mikrošob Prikaz ugradnje mikromlaznica Betty 190x90			

Kopalne in masažne kadi

Kade za kupanje i masažne kade

Program:**kolpa·san**
BY KOLPA









Model	Naziv in dimenzija izdelka Naziv i dimenzije produkta	Opis Opis	EAN koda EAN koda	Cena EUR Cijena EUR
Dodatki za / Dodaci za Betty 190x90				
	WATERFALL 	enoročna armatura s tuš ročico in izlivom / jednoručna armatura s tuš ručicom i izljevom	3838987 734543	590,00
	GEYSER 	enoročna arm. s tuš ročico in polnilno /odlivno prelivno gar. za polnjenje kadi jednoručna arm. s tuš ručicom i priljev/odljev prelivnom garniturom za punjenje kade	3838987 506287	633,00
	RAINDROP 	enoročna armatura s tuš ročico in izlivom / jednoručna armatura s tuš ručicom i izljevom	3838987 726500	620,00
	UP&DOWN, WHITE	prelivna garnitura s sifonom, bela prelivna garnitura sa sifonom, bijela	3838987 922759	65,00
	PAL 650, CHR	prelivna garnitura s sifonom, krom prelivna garnitura sa sifonom, krom	3838987 746270	58,00
	HEADREST SOFT	vzglavnik naslon za glavu	3838987 593942	83,00
	HEADREST COAST	vzglavnik naslon za glavu	3838987 593928	108,00
	PKK 501	podnožje kopalne kadi za vgradnjo podnožje kupaonske kade za ugradnju	3838987 764878	29,00
	Zidni montažni set Zidni montažni set	za kopalne in tuš kadi za vgradnjo za kupaonske i tuš kade za ugradnju	3838987 704362	12,00
	Montažni set za oblogo /magnet Montažni set za oblogo / magnet	za kopalne kadi (v primeru dodatne kratke obloge) / za kupaonske kade (u primeru dodatne kratke obloge)	3838987 590750	29,00
	Suhomontažna zaključna letev Završna letva u sistemu suhe montaže	karton 25 kosov / karton 25 komada (Cena za kos / Cijena na komad 32,00 EUR)	3838987 903116	800,00
	Chromoterapia (CTL) Chromoterapia (CTL)	2 LED lučki s samostojno tipkovnico 2 LED svjetla sa samostalnom tipkovnicom		401,00
	Dve dodatni mikro šobi Dvije dodatne mikro mlaznice	za masažo stopal (kpl) za masažu stopala (kpl)		64,00
	Servisno prezračevalni pokrov z rešetko Servisno ventilacijski pokrov s rešetkom	za masažne kadi za vgradnjo (45x45 cm) za masažne kade za ugradnju (45x45 cm)	3838987 534808	95,00
	ANTI-SLIP PREMAZ	protizdrsni premaz za kopalne kadi protiv klizni premaz za kupaonske kade (min. kol. 10 kos)		70,00
	Specialno čistilo KOLPA SAN Specialno sredstvo za čiščenje	karton 20 kosov / karton 20 komada (Cena za kos / Cijena na komad 6,50 EUR)	3838987 747291	130,00
	Specialno čistilo ECO SAN Specialno sredstvo za čiščenje	karton 20 kosov / karton 20 komada (Cena za kos / Cijena na komad 5,70 EUR)	3838987 572220	114,00
	Čistilo za masažne sisteme Sredstvo za čiščenje masažnih sistema	karton 10 kosov / karton 10 komada (Cena za kos / Cijena na komad 8,20 EUR)	3838987 747277	82,00



Kopalne in masažne kadi
Kade za kupanje i masažne kade

Program:













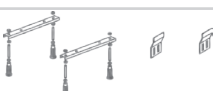

kolpa·san
BY KOLPA

Model	Naziv in dimenzija izdelka Naziv i dimenzije produkta	Opis Opis	EAN koda EAN koda	Cena EUR Cijena EUR
Betty 180x80				
	Betty 180x80	kopalna kad za vgradnjo kada za ugradnju	3838987 565192	307,00
	A 180/63	dolga obloga duga obloga	3838987 565215	77,00
	A 80/63	kratka obloga kratka obloga	3838987 565222	51,00
	CM 180-200	podnožje kopalne kadi za oblogo podnožje kupaonske kade za oblogu	3838987 573012	125,00
	Betty E2 180x80	kopalna kad za vgradnjo kada za ugradnju višina roba kadi = 20 mm visina ruba kade = 20 mm * Ni možnosti v kombinaciji z oblogo, niti z masažnim sistemom	3838987 705338	337,00
	Vodni masažni sistem I. Vodeni masažni sistem I. PNEVMATSKI Betty 180x80	z oblogo s oblogom	3838987 513803	1.391,00
		z oblogo + mikrošobe s oblogom + mikromlaznice	3838987 513810	1.957,00
	Kombinirani (vodni in zračni) masažni sistem / Kombinirani (vodeni i zračni) masažni sistem ELEKTRONSKI Betty 180x80	z oblogo s oblogom	3838987 513827	2.638,00
		z oblogo + mikrošobe s oblogom + mikromlaznice	3838987 513834	3.205,00
	Vital masažni sistem Vital masažni sistem ELEKTRONSKI Betty 180x80	z oblogo + mikrošobe s oblogom + mikromlaznice	3838987 513841	4.211,00
Vgradnja mikrošob v kad Ugradnja mikromlaznica u kadu Betty 180x80				
	Prikaz vgradnje mikrošob Prikaz ugradnje mikromlaznica Betty 180x80			

Kopalne in masažne kadi

Kade za kupanje i masažne kade

Program:**kolpa·san**
BY KOLPA









Model	Naziv in dimenzija izdelka Naziv i dimenzije produkta	Opis Opis	EAN koda EAN koda	Cena EUR Cijena EUR
Dodatki za / Dodaci za Betty 180x80				
	GEYSER 	enoročna arm. s tuš ročico in polnilno /odlivno prelivno gar. za polnjenje kadi jednoročna arm. s tuš ručicom i priljev/odljev prelivnom garniturom za punjenje kada	3838987 506287	633,00
	RAINDROP 	enoročna armatura s tuš ročico in izlivom / jednoročna armatura s tuš ručicom i izljevom	3838987 726500	620,00
	UP&DOWN, WHITE	prelivna garnitura s sifonom, bela prelivna garnitura sa sifonom, bijela	3838987 922759	65,00
	PAL 650, CHR	prelivna garnitura s sifonom, krom prelivna garnitura sa sifonom, krom	3838987 746270	58,00
	HEADREST SOFT	vzglavnik naslon za glavu	3838987 593942	83,00
	HEADREST COAST	vzglavnik naslon za glavu	3838987 593928	108,00
	PKK 501	podnožje kopalne kadi za vgradnjo podnožje kupaonske kade za ugradnju	3838987 764878	29,00
	Zidni montažni set Zidni montažni set	za kopalne in tuš kadi za vgradnjo za kupaonske i tuš kade za ugradnju	3838987 704362	12,00
	Montažni set za oblogo /magnet Montažni set za oblogu / magnet	za kopalne kadi (v primeru dodatne kratke obloge) / za kupaonske kade (u primeru dodatne kratke obloge)	3838987 590750	29,00
	Suhomontažna zaključna letev Završna letva u sistemu suhe montaže	karton 25 kosov / karton 25 komada (Cena za kos / Cijena na komad 32,00 EUR)	3838987 903116	800,00
	Chromotherapie (CTL) Chromotherapie (CTL)	2 LED lučki s samostojno tipkovnico 2 LED svjetla sa samostalnom tipkovnicom		401,00
	Dve dodatni mikro šobi Dvije dodatne mikro mlaznice	za masažo stopal (kpl) za masažu stopala (kpl)		64,00
	Servisno prezračevalni pokrov z rešetko Servisno ventilacijski pokrov s rešetkom	za masažne kadi za vgradnjo (45x45 cm)	3838987 534808	95,00
	ANTI-SLIP PREMAZ	protizdrsni premaz za kopalne kadi protiv klizni premaz za kupaonske kade (min. kol. 10 kos)		70,00
	Specialno čistilo KOLPA SAN Specialno sredstvo za čiščenje	karton 20 kosov / karton 20 komada (Cena za kos / Cijena na komad 6,50 EUR)	3838987 747291	130,00
	Specialno čistilo ECO SAN Specialno sredstvo za čiščenje	karton 20 kosov / karton 20 komada (Cena za kos / Cijena na komad 5,70 EUR)	3838987 572220	114,00
	Čistilo za masažne sisteme Sredstvo za čiščenje masažnih sistema	karton 10 kosov / karton 10 komada (Cena za kos / Cijena na komad 8,20 EUR)	3838987 747277	82,00



Kopalne in masažne kadi
Kade za kupanje i masažne kade

Program:













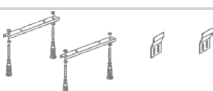

kolpa·san
BY KOLPA

Model	Naziv in dimenzija izdelka Naziv i dimenzije produkta	Opis Opis	EAN koda EAN koda	Cena EUR Cijena EUR
Betty 170x80				
	Betty 170x80	kopalna kad za vgradnjo kada za ugradnju	3838987 565925	292,00
	A 170/63	dolga obloga duga obloga	3838987 565376	77,00
	A 80/63	kratka obloga kratka obloga	3838987 565222	51,00
	CM 160-170	podnožje kopalne kadi za oblogo podnožje kupaonske kade za oblogu	3838987 573005	125,00
	Betty E2 170x80	kopalna kad za vgradnjo kada za ugradnju višina roba kadi = 20 mm visina ruba kade = 20 mm * Ni možnosti v kombinaciji z oblogo, niti z masažnim sistemom	3838987 705321	321,00
	Vodni masažni sistem I. Vodeni masažni sistem I. PNEVMATSKI Betty 170x80	z oblogo s oblogom	3838987 513759	1.378,00
		z oblogo + mikrošobe s oblogom + mikromlaznice	3838987 513766	1.944,00
	Kombinirani (vodni in zračni) masažni sistem / Kombinirani (vodni i zračni) masažni sistem ELEKTRONSKI Betty 170x80	z oblogo s oblogom	3838987 513773	2.625,00
		z oblogo + mikrošobe s oblogom + mikromlaznice	3838987 513780	3.191,00
	Vital masažni sistem Vital masažni sistem ELEKTRONSKI Betty 170x80	z oblogo + mikrošobe s oblogom + mikromlaznice	3838987 513797	4.198,00
Vgradnja mikrošob v kad Ugradnja mikromlaznica u kadi Betty 170x80				
	Prikaz vgradnje mikrošob Prikaz ugradnje mikromlaznica Betty 170x80			

Kopalne in masažne kadi

Kade za kupanje i masažne kade

Program:**kolpa·san**
BY KOLPA









Model	Naziv in dimenzija izdelka Naziv i dimenzije produkta	Opis Opis	EAN koda EAN koda	Cena EUR Cijena EUR
Dodatki za / Dodaci za Betty 170x80				
	GEYSER 	enoročna arm. s tuš ročico in polnilno /odlivno prelivno gar. za polnjenje kadi jednoročna arm. s tuš ručicom i priljev/odljev prelivnom garnituroom za punjenje kada	3838987 506287	633,00
	RAINDROP 	enoročna armatura s tuš ročico in izlivom / jednoročna armatura s tuš ručicom i izljevom	3838987 726500	620,00
	UP&DOWN, WHITE	prelivna garnitura s sifonom, bela prelivna garnitura sa sifonom, bijela	3838987 922759	65,00
	PAL 650, CHR	prelivna garnitura s sifonom, krom prelivna garnitura sa sifonom, krom	3838987 746270	58,00
	HEADREST SOFT	vzglavnik naslon za glavu	3838987 593942	83,00
	HEADREST COAST	vzglavnik naslon za glavu	3838987 593928	108,00
	PKK 501	podnožje kopalne kadi za vgradnjo podnožje kupaonske kade za ugradnju	3838987 764878	29,00
	Zidni montažni set Zidni montažni set	za kopalne in tuš kadi za vgradnjo za kupaonske i tuš kade za ugradnju	3838987 704362	12,00
	Montažni set za oblogo /magnet Montažni set za oblogu / magnet	za kopalne kadi (v primeru dodatne kratke obloge) / za kupaonske kade (u primeru dodatne kratke obloge)	3838987 590750	29,00
	Suhomontažna zaključna letev Završna letva u sistemu suhe montaže	karton 25 kosov / karton 25 komada (Cena za kos / Cijena na komad 32,00 EUR)	3838987 903116	800,00
	Chromoterapia (CTL) Chromoterapia (CTL)	2 LED lučki s samostojno tipkovnico 2 LED svjetla sa samostalnom tipkovnicom		401,00
	Dve dodatni mikro šobi Dvije dodatne mikro mlaznice	za masažo stopal (kpl) za masažu stopala (kpl)		64,00
	Servisno prezračevalni pokrov z rešetko Servisno ventilacijski pokrov s rešetkom	za masažne kadi za vgradnjo (45x45 cm) za masažne kade za ugradnju (45x45 cm)	3838987 534808	95,00
	ANTI-SLIP PREMAZ	protizdrsni premaz za kopalne kadi protiv klizni premaz za kupaonske kade (min. kol. 10 kos)		70,00
	Specialno čistilo KOLPA SAN Specialno sredstvo za čiščenje	karton 20 kosov / karton 20 komada (Cena za kos / Cijena na komad 6,50 EUR)	3838987 747291	130,00
	Specialno čistilo ECO SAN Specialno sredstvo za čiščenje	karton 20 kosov / karton 20 komada (Cena za kos / Cijena na komad 5,70 EUR)	3838987 572220	114,00
	Čistilo za masažne sisteme Sredstvo za čiščenje masažnih sistema	karton 10 kosov / karton 10 komada (Cena za kos / Cijena na komad 8,20 EUR)	3838987 747277	82,00



Kopalne in masažne kadi

Kade za kupanje i masažne kade

















Program:**kolpa·san**
BY KOLPA

Model	Naziv in dimenzija izdelka Naziv i dimenzije produkta	Opis Opis	EAN koda EAN koda	Cena EUR Cijena EUR
Betty 170x75				
	Betty 170x75	kopalna kad za vgradnjo kada za ugradnju	3838987 565352	273,00
	A 170/63	dolga obloga duga obloga	3838987 565376	77,00
	A 75/63	kratka obloga kratka obloga	3838987 565369	47,00
	CM 160-170	podnožje kopalne kadi za oblogo podnožje kupaonske kade za oblogu	3838987 573005	125,00
	Betty E2 170x75	kopalna kad za vgradnjo kada za ugradnju višina roba kadi = 20 mm visina ruba kade = 20 mm * Ni možnosti v kombinaciji z oblogo, niti z masažnim sistemom	3838987 705345	300,00
	Vodni masažni sistem I. Vodeni masažni sistem I. PNEVMATSKI Betty 170x75	z oblogo s oblogom z oblogo + mikrošobe s oblogom + mikromlaznice	3838987 513605 3838987 513612	1.361,00 1.927,00
	Kombinirani (vodni in zračni) masažni sistem / Kombinirani (vodeni i zračni) masažni sistem ELEKTRONSKI Betty 170x75	z oblogo s oblogom z oblogo + mikrošobe s oblogom + mikromlaznice	3838987 513629 3838987 513636	2.607,00 3.174,00
	Vital masažni sistem Vital masažni sistem ELEKTRONSKI Betty 170x75	z oblogo + mikrošobe s oblogom + mikromlaznice	3838987 513643	4.180,00
Vgradnja mikrošob v kad Ugradnja mikromlaznica u kado Betty 170x75				
	Prikaz vgradnje mikrošob Prikaz ugradnje mikromlaznica Betty 170x75			

Kopalne in masažne kadi
Kade za kupanje i masažne kade

Program:

kolpa·san
BY KOLPA









Model	Naziv in dimenzija izdelka Naziv i dimenzije produkta	Opis Opis	EAN koda EAN koda	Cena EUR Cijena EUR
Dodatki za / Dodaci za Betty 170x75				
	GEYSER 	enoročna arm. s tuš ročico in polnilno /odlivno prelivno gar. za polnjenje kadi jednoročna arm. s tuš ručicom i priljev/odljev prelivnom garniturom za punjenje kada	3838987 506287	633,00
	RAINDROP 	enoročna armatura s tuš ročico in izlivom / jednoročna armatura s tuš ručicom i izljevom	3838987 726500	620,00
	UP&DOWN, WHITE	prelivna garnitura s sifonom, bela prelivna garnitura sa sifonom, bijela	3838987 922759	65,00
	PAL 650, CHR	prelivna garnitura s sifonom, krom prelivna garnitura sa sifonom, krom	3838987 746270	58,00
	HEADREST SOFT	vzglavnik naslon za glavu	3838987 593942	83,00
	HEADREST COAST	vzglavnik naslon za glavu	3838987 593928	108,00
	SKK	sedež za kopalno kad sjedalo za kupaonsku kadu	3838987 950943	106,00
	PKK 501	podnožje kopalne kadi za vgradnjo podnožje kupaonske kade za ugradnju	3838987 764878	29,00
	Zidni montažni set Zidni montažni set	za kopalne in tuš kadi za vgradnjo za kupaonske i tuš kade za ugradnju	3838987 704362	12,00
	Montažni set za oblogo /magnet Montažni set za oblogu / magnet	za kopalne kadi (v primeru dodatne kratke obloge) / za kupaonske kade (u primeru dodatne kratke obloge)	3838987 590750	29,00
	Suhomontažna zaključna letva Završna letva u sistemu suhe montaže	karton 25 kosov / karton 25 komada (Cena za kos / Cijena na komad 32,00 EUR)	3838987 903116	800,00
	Chromotherapie (CTL) Chromotherapie (CTL)	2 LED lučki s samostojno tipkovnico 2 LED svjetla sa samostalnom tipkovnicom		401,00
	Dve dodatni mikro šobi Dvije dodatne mikro mlaznice	za masažo stopal (kpl) za masažu stopala (kpl)		64,00
	Servisno prezračevalni pokrov z rešetko Servisno ventilacijski pokrov s rešetkom	za masažne kadi za vgradnjo (45x45 cm) za masažne kade za ugradnju (45x45 cm)	3838987 534808	95,00
	ANTI-SLIP PREMAZ	protizdrsni premaz za kopalne kadi protiv klizni premaz za kupaonske kade (min. kol. 10 kos)		70,00
	Specialno čistilo KOLPA SAN Specialno sredstvo za čišćenje	karton 20 kosov / karton 20 komada (Cena za kos / Cijena na komad 6,50 EUR)	3838987 747291	130,00
	Specialno čistilo ECO SAN Specialno sredstvo za čišćenje	karton 20 kosov / karton 20 komada (Cena za kos / Cijena na komad 5,70 EUR)	3838987 572220	114,00
	Čistilo za masažne sisteme Sredstvo za čišćenje masažnih sistema	karton 10 kosov / karton 10 komada (Cena za kos / Cijena na komad 8,20 EUR)	3838987 747277	82,00



Kopalne in masažne kadi
Kade za kupanje i masažne kade

Program:

kolpa·san
BY KOLPA















Model	Naziv in dimenzija izdelka Naziv i dimenzije produkta	Opis Opis	EAN koda EAN koda	Cena EUR Cijena EUR
Betty 170x70				
	Betty 170x70	kopalna kad za vgradnjo kada za ugradnju	3838987 565383	273,00
	A 170/63	dolga obloga duga obloga	3838987 565376	77,00
	A 70/63	kratka obloga kratka obloga	3838987 565390	47,00
	CM 160-170	podnožje kopalne kadi za oblogo podnožje kupaonske kade za oblogu	3838987 573005	125,00
	Betty E2 170x70	kopalna kad za vgradnjo kada za ugradnju višina roba kadi = 20 mm visina ruba kade = 20 mm * Ni možnosti v kombinaciji z oblogo, niti z masažnim sistemom	3838987 705352	300,00
	Vodni masažni sistem I. Vodeni masažni sistem I. PNEVMATSKI Betty 170x70	z oblogo s oblogom	3838987 513568	1.361,00
		z oblogo + mikrošobe s oblogom + mikromlaznice	3838987 513575	1.927,00
	Kombinirani (vodni in zračni) masažni sistem / Kombinirani (vodeni i zračni) masažni sistem ELEKTRONSKI Betty 170x70	z oblogo s oblogom	3838987 513582	2.607,00
		z oblogo + mikrošobe s oblogom + mikromlaznice	3838987 513590	3.174,00
Vgradnja mikrošob v kad Ugradnja mikromlaznica u kadu Betty 170x70				
	Prikaz vgradnje mikrošob Prikaz ugradnje mikromlaznica Betty 170x70			

Kopalne in masažne kadi

Kade za kupanje i masažne kade

Program:

kolpa·san
BY KOLPA







Model	Naziv in dimenzija izdelka Naziv i dimenzije produkta	Opis Opis	EAN koda EAN koda	Cena EUR Cijena EUR
Dodatki za / Dodaci za Betty 170x70				
	GEYSER 	enoročna arm. s tuš ročico in polnilno /odlivno prelivno gar. za polnjenje kadi jednoročna arm. s tuš ručicom i priljev/odljev prelivnom garniturom za punjenje kada	3838987 506287	633,00
	RAINDROP 	enoročna armatura s tuš ročico in izlivom / jednoročna armatura s tuš ručicom i izljevom	3838987 726500	620,00
	UP&DOWN, WHITE	prelivna garnitura s sifonom, bela prelivna garnitura sa sifonom, bijela	3838987 922759	65,00
	PAL 650, CHR	prelivna garnitura s sifonom, krom prelivna garnitura sa sifonom, krom	3838987 746270	58,00
	HEADREST SOFT	vzglavnik naslon za glavu	3838987 593942	83,00
	HEADREST COAST	vzglavnik naslon za glavu	3838987 593928	108,00
	SKK	sedež za kopalno kad sjedalo za kupaonsku kadu	3838987 950943	106,00
	PKK 501	podnožje kopalne kadi za vgradnjo podnožje kupaonske kade za ugradnju	3838987 764878	29,00
	Zidni montažni set Zidni montažni set	za kopalne in tuš kadi za vgradnjo za kupaonske i tuš kade za ugradnju	3838987 704362	12,00
	Montažni set za oblogo /magnet Montažni set za oblogu / magnet	za kopalne kadi (v primeru dodatne kratke obloge) / za kupaonske kade (u primeru dodatne kratke obloge)	3838987 590750	29,00
	Suhomontažna zaključna letva Završna letva u sistemu suhe montaže	karton 25 kosov / karton 25 komada (Cena za kos / Cijena na komad 32,00 EUR)	3838987 903116	800,00
	Chromotherapie (CTL) Chromotherapie (CTL)	2 LED lučki s samostojno tipkovnico 2 LED svjetla sa samostalnom tipkovnicom		401,00
	Servisno prezračevalni pokrov z rešetko Servisno ventilacijski pokrov s rešetkom	za masažne kadi za vgradnjo (45x45 cm) za masažne kade za ugradnju (45x45 cm)	3838987 534808	95,00
	ANTI-SLIP PREMAZ	protizdrsni premaz za kopalne kadi protiv klizni premaz za kupaonske kade (min. kol. 10 kos)		70,00
	Specialno čistilo KOLPA SAN Specialno sredstvo za čišćenje	karton 20 kosov / karton 20 komada (Cena za kos / Cijena na komad 6,50 EUR)	3838987 747291	130,00
	Specialno čistilo ECO SAN Specialno sredstvo za čišćenje	karton 20 kosov / karton 20 komada (Cena za kos / Cijena na komad 5,70 EUR)	3838987 572220	114,00
	Čistilo za masažne sisteme Sredstvo za čišćenje masažnih sistema	karton 10 kosov / karton 10 komada (Cena za kos / Cijena na komad 8,20 EUR)	3838987 747277	82,00



Kopalne in masažne kadi
Kade za kupanje i masažne kade

Program:

kolpa·san
BY KOLPA















Model	Naziv in dimenzija izdelka Naziv i dimenzije produkta	Opis Opis	EAN koda EAN koda	Cena EUR Cijena EUR
Betty 160x70				
	Betty 160x70	kopalna kad za vgradnjo kada za ugradnju	3838987 565437	273,00
	A 160/63	dolga obloga duga obloga	3838987 565444	77,00
	A 70/63	kratka obloga kratka obloga	3838987 565390	47,00
	CM 160-170	podnožje kopalne kadi za oblogo podnožje kupaonske kade za oblogu	3838987 573005	125,00
	Vodni masažni sistem I. Vodeni masažni sistem I. PNEVMATSKI Betty 160x70	z oblogo s oblogom z oblogo + mikrošobe s oblogom + mikromlaznice	3838987 513520 3838987 513537	1.361,00 1.927,00
	Kombinirani (vodni in zračni) masažni sistem / Kombinirani (vodeni i zračni) masažni sistem ELEKTRONSKI Betty 160x70	z oblogo s oblogom z oblogo + mikrošobe s oblogom + mikromlaznice	3838987 513544 3838987 513551	2.607,00 3.174,00
Vgradnja mikrošob v kad Ugradnja mikromlaznica u kadu Betty 160x70				
	Prikaz vgradnje mikrošob Prikaz ugradnje mikromlaznica Betty 160x70			

Kopalne in masažne kadi

Kade za kupanje i masažne kade

Program:

kolpa·san
BY KOLPA





Model	Naziv in dimenzija izdelka Naziv i dimenzije produkta	Opis Opis	EAN koda EAN koda	Cena EUR Cijena EUR
Dodatki za / Dodaci za Betty 160x70				
	GEYSER 	enoročna arm. s tuš ročico in polnilno /odlivno prelivno gar. za polnjenje kadi jednoročna arm. s tuš ročicom i priljev/odljev prelivnom garnituroom za punjenje kada	3838987 506287	633,00
	RAINDROP 	enoročna armatura s tuš ročico in izlivom / jednoročna armatura s tuš ročicom i izlivom	3838987 726500	620,00
	UP&DOWN, WHITE	prelivna garnitura s sifonom, bela prelivna garnitura sa sifonom, bijela	3838987 922759	65,00
	PAL 650, CHR	prelivna garnitura s sifonom, krom prelivna garnitura sa sifonom, krom	3838987 746270	58,00
	HEADREST SOFT	vzglavnik naslon za glavu	3838987 593942	83,00
	HEADREST COAST	vzglavnik naslon za glavu	3838987 593928	108,00
	SKK	sedež za kopalno kad sjedalo za kupaonsku kadu	3838987 950943	106,00
	PKK 501	podnožje kopalne kadi za vgradnjo podnožje kupaonske kade za ugradnju	3838987 764878	29,00
	Zidni montažni set Zidni montažni set	za kopalne in tuš kadi za vgradnjo za kupaonske i tuš kade za ugradnju	3838987 704362	12,00
	Montažni set za oblogo /magnet Montažni set za oblogo / magnet	za kopalne kadi (v primeru dodatne kratke obloge) / za kupaonske kade (u primeru dodatne kratke obloge)	3838987 590750	29,00
	Suhomontažna zaključna letva Završna letva u sistemu suhe montaže	karton 25 kosov / karton 25 komada (Cena za kos / Cijena na komad 32,00 EUR)	3838987 903116	800,00
	Chromotherapia (CTL) Chromotherapia (CTL)	2 LED lučki s samostojno tipkovnico 2 LED svjetla sa samostalnom tipkovnicom		401,00
	Servisno prezračevalni pokrov z rešetko Servisno ventilacijski pokrov s rešetkom	za masažne kadi za vgradnjo (45x45 cm) za masažne kade za ugradnju (45x45 cm)	3838987 534808	95,00
	ANTI-SLIP PREMAZ	protizdrsni premaz za kopalne kadi protiv klizni premaz za kupaonske kade (min. kol. 10 kos)		70,00
	Specialno čištilo KOLPA SAN Specialno sredstvo za čiščenje	karton 20 kosov / karton 20 komada (Cena za kos / Cijena na komad 6,50 EUR)	3838987 747291	130,00
	Specialno čištilo ECO SAN Specialno sredstvo za čiščenje	karton 20 kosov / karton 20 komada (Cena za kos / Cijena na komad 5,70 EUR)	3838987 572220	114,00
	Čištilo za masažne sisteme Sredstvo za čiščenje masažnih sistema	karton 10 kosov / karton 10 komada (Cena za kos / Cijena na komad 8,20 EUR)	3838987 747277	82,00



Kopalne in masažne kadi

Kade za kupanje i masažne kade















Program:**kolpa·san**
by KOLPA

Model	Naziv in dimenzija izdelka Naziv i dimenzije produkta	Opis Opis	EAN koda EAN koda	Cena EUR Cijena EUR
Betty 150x70				
	Betty 150x70	kopalna kad za vgradnjo kada za ugradnju	3838987 565505	259,00
	A 150/63	dolga obloga duga obloga	3838987 565543	68,00
	A 70/63	kratka obloga kratka obloga	3838987 565390	47,00
	CM 120-150	podnožje kopalne kadi za oblogo podnožje kupaonske kade za oblogu	3838987 572992	125,00

Kopalne in masažne kadi
Kade za kupanje i masažne kade

Program:

kolpa·san
BY KOLPA





Model	Naziv in dimenzija izdelka Naziv i dimenzije produkta	Opis Opis	EAN koda EAN koda	Cena EUR Cijena EUR
Dodatki za / Dodaci za Betty 150x70				
	GEYSER 	enoročna arm. s tuš ročico in polnilno /odlivno prelivno gar. za polnjenje kadi jednoročna arm. s tuš ručicom i priljev/odljev prelivnom garniturom za punjenje kada	3838987 506287	633,00
	RAINDROP 	enoročna armatura s tuš ročico in izlivom / jednoročna armatura s tuš ručicom i izljevom	3838987 726500	620,00
	UP&DOWN, WHITE	prelivna garnitura s sifonom, bela prelivna garnitura sa sifonom, bijela	3838987 922759	65,00
	PAL 650, CHR	prelivna garnitura s sifonom, krom prelivna garnitura sa sifonom, krom	3838987 746270	58,00
	HEADREST SOFT	vzglavnik naslon za glavu	3838987 593942	83,00
	HEADREST COAST	vzglavnik naslon za glavu	3838987 593928	108,00
	SKK	sedež za kopalno kad sjedalo za kupaonsku kadu	3838987 950943	106,00
	PKK 501	podnožje kopalne kadi za vgradnjo podnožje kupaonske kade za ugradnju	3838987 764878	29,00
	Zidni montažni set Zidni montažni set	za kopalne in tuš kadi za vgradnjo za kupaonske i tuš kade za ugradnju	3838987 704362	12,00
	Montažni set za oblogo /magnet Montažni set za oblogu / magnet	za kopalne kadi (v primeru dodatne kratke obloge) / za kupaonske kade (u primeru dodatne kratke obloge)	3838987 590750	29,00
	Suhomontažna zaključna letva Završna letva u sistemu suhe montaže	karton 25 kosov / karton 25 komada (Cena za kos / Cijena na komad 32,00 EUR)	3838987 903116	800,00
	Servisno prezračevalni pokrov z rešetko Servisno ventilacijski pokrov s rešetkom	za masažne kadi za vgradnjo (45x45 cm) za masažne kade za ugradnju (45x45 cm)	3838987 534808	95,00
	ANTI-SLIP PREMAZ	protizdrsni premaz za kopalne kadi protiv klizni premaz za kupaonske kade (min. kol. 10 kos)		70,00
	Specialno čistilo KOLPA SAN Specialno sredstvo za čišćenje	karton 20 kosov / karton 20 komada (Cena za kos / Cijena na komad 6,50 EUR)	3838987 747291	130,00
	Specialno čistilo ECO SAN Specialno sredstvo za čišćenje	karton 20 kosov / karton 20 komada (Cena za kos / Cijena na komad 5,70 EUR)	3838987 572220	114,00



Kopalne in masažne kadi

Kade za kupanje i masažne kade















Program:**kolpa·san**
by KOLPA

Model	Naziv in dimenzija izdelka Naziv i dimenzije produkta	Opis Opis	EAN koda EAN koda	Cena EUR Cijena EUR
Betty 140x70				
	Betty 140x70	kopalna kad za vgradnjo kada za ugradnju	3838987 565512	245,00
	A 140/63	dolga obloga duga obloga	3838987 565550	68,00
	A 70/63	kratka obloga kratka obloga	3838987 565390	47,00
	CM 120-150	podnožje kopalne kadi za oblogo podnožje kupaonske kade za oblogu	3838987 572992	125,00

Kopalne in masažne kadi
Kade za kupanje i masažne kade

Program:

kolpa·san
BY KOLPA





Model	Naziv in dimenzija izdelka Naziv i dimenzije produkta	Opis Opis	EAN koda EAN koda	Cena EUR Cijena EUR
Dodatki za / Dodaci za Betty 140x70				
	GEYSER 	enoročna arm. s tuš ročico in polnilno /odlivno prelivno gar. za polnjenje kadi jednoročna arm. s tuš ručicom i priljev/odljev prelivnom garniturom za punjenje kada	3838987 506287	633,00
	RAINDROP 	enoročna armatura s tuš ročico in izlivom / jednoročna armatura s tuš ručicom i izljevom	3838987 726500	620,00
	UP&DOWN, WHITE	prelivna garnitura s sifonom, bela prelivna garnitura sa sifonom, bijela	3838987 922759	65,00
	PAL 650, CHR	prelivna garnitura s sifonom, krom prelivna garnitura sa sifonom, krom	3838987 746270	58,00
	HEADREST SOFT	vzglavnik naslon za glavu	3838987 593942	83,00
	HEADREST COAST	vzglavnik naslon za glavu	3838987 593928	108,00
	SKK	sedež za kopalno kad sjedalo za kupaonsku kadu	3838987 950943	106,00
	PKK 501	podnožje kopalne kadi za vgradnjo podnožje kupaonske kade za ugradnju	3838987 764878	29,00
	Zidni montažni set Zidni montažni set	za kopalne in tuš kadi za vgradnjo za kupaonske i tuš kade za ugradnju	3838987 704362	12,00
	Montažni set za oblogo /magnet Montažni set za oblogu / magnet	za kopalne kadi (v primeru dodatne kratke obloge) / za kupaonske kade (u primeru dodatne kratke obloge)	3838987 590750	29,00
	Suhomontažna zaključna letva Završna letva u sistemu suhe montaže	karton 25 kosov / karton 25 komada (Cena za kos / Cijena na komad 32,00 EUR)	3838987 903116	800,00
	Servisno prezračevalni pokrov z rešetko Servisno ventilacijski pokrov s rešetkom	za masažne kadi za vgradnjo (45x45 cm) za masažne kade za ugradnju (45x45 cm)	3838987 534808	95,00
	ANTI-SLIP PREMAZ	protizdrsni premaz za kopalne kadi protiv klizni premaz za kupaonske kade (min. kol. 10 kos)		70,00
	Specialno čistilo KOLPA SAN Specialno sredstvo za čiščenje	karton 20 kosov / karton 20 komada (Cena za kos / Cijena na komad 6,50 EUR)	3838987 747291	130,00
	Specialno čistilo ECO SAN Specialno sredstvo za čiščenje	karton 20 kosov / karton 20 komada (Cena za kos / Cijena na komad 5,70 EUR)	3838987 572220	114,00



Kopalne in masažne kadi

Kade za kupanje i masažne kade











Program:**kolpa·san**
by KOLPA

Model	Naziv in dimenzija izdelka Naziv i dimenzije produkta	Opis Opis	EAN koda EAN koda	Cena EUR Cijena EUR
Betty 130x70				
	Betty 130x70	kopalna kad za vgradnjo kada za ugradnju	3838987 565529	245,00
	A 130/63	dolga obloga duga obloga	3838987 565567	68,00
	A 70/63	kratka obloga kratka obloga	3838987 565390	47,00
	CM 120-150	podnožje kopalne kadi za oblogo podnožje kupaonske kade za oblogu	3838987 572992	125,00

Kopalne in masažne kadi

Kade za kupanje i masažne kade

Program:**kolpa·san**
BY KOLPA





Model	Naziv in dimenzija izdelka Naziv i dimenzije produkta	Opis Opis	EAN koda EAN koda	Cena EUR Cijena EUR
Dodatki za / Dodaci za Betty 130x70				
	UP&DOWN, WHITE	prelivna garnitura s sifonom, bela prelivna garnitura sa sifonom, bijela	3838987 922759	65,00
	PAL 650, CHR	prelivna garnitura s sifonom, krom prelivna garnitura sa sifonom, krom	3838987 746270	58,00
	HEADREST SOFT	vzglavnik naslon za glavu	3838987 593942	83,00
	HEADREST COAST	vzglavnik naslon za glavu	3838987 593928	108,00
	SKK	sedež za kopalno kad sjedalo za kupaonsku kadu	3838987 950943	106,00
	PKK 501	podnožje kopalne kadi za vgradnjo podnožje kupaonske kade za ugradnju	3838987 764878	29,00
	Zidni montažni set Zidni montažni set	za kopalne in tuš kadi za vgradnjo za kupaonske i tuš kade za ugradnju	3838987 704362	12,00
	Montažni set za oblogo /magnet Montažni set za oblogo / magnet	za kopalne kadi (v primeru dodatne kratke obloge) / za kupaonske kade (u primeru dodatne kratke obloge)	3838987 590750	29,00
	Suhomontažna zaključna letva Završna letva u sistemu suhe montaže	karton 25 kosov / karton 25 komada (Cena za kos / Cijena na komad 32,00 EUR)	3838987 903116	800,00
	Servisno prezračevalni pokrov z rešetko Servisno ventilacijski pokrov s rešetkom	za masažne kadi za vgradnjo (45x45 cm) za masažne kade za ugradnju (45x45 cm)	3838987 534808	95,00
	ANTI-SLIP PREMAZ	protizdrsni premaz za kopalne kadi protiv klizni premaz za kupaonske kade (min. kol. 10 kos)		70,00
	Specialno čistilo KOLPA SAN Specialno sredstvo za čiščenje	karton 20 kosov / karton 20 komada (Cena za kos / Cijena na komad 6,50 EUR)	3838987 747291	130,00
	Specialno čistilo ECO SAN Specialno sredstvo za čiščenje	karton 20 kosov / karton 20 komada (Cena za kos / Cijena na komad 5,70 EUR)	3838987 572220	114,00



Kopalne in masažne kadi

Kade za kupanje i masažne kade











Program:**kolpa·san**
BY KOLPA

Model	Naziv in dimenzija izdelka Naziv i dimenzije produkta	Opis Opis	EAN koda EAN koda	Cena EUR Cijena EUR
Betty 120x70				
	Betty 120x70	kopalna kad za vgradnjo kada za ugradnju	3838987 565536	245,00
	A 120/63	dolga obloga duga obloga	3838987 565574	68,00
	A 70/63	kratka obloga kratka obloga	3838987 565390	47,00
	CM 120-150	podnožje kopalne kadi za oblogo podnožje kupaonske kade za oblogu	3838987 572992	125,00

Kopalne in masažne kadi

Kade za kupanje i masažne kade

Program:**kolpa·san**
BY KOLPA







Model	Naziv in dimenzija izdelka Naziv i dimenzije produkta	Opis Opis	EAN koda EAN koda	Cena EUR Cijena EUR
Dodatki za / Dodaci za Betty 120x70				
	UP&DOWN, WHITE	prelivna garnitura s sifonom, bela prelivna garnitura sa sifonom, bijela	3838987 922759	65,00
	PAL 650, CHR	prelivna garnitura s sifonom, krom prelivna garnitura sa sifonom, krom	3838987 746270	58,00
	HEADREST SOFT	vzglavnik naslon za glavu	3838987 593942	83,00
	HEADREST COAST	vzglavnik naslon za glavu	3838987 593928	108,00
	SKK	sedež za kopalno kad sjedalo za kupaonsku kado	3838987 950943	106,00
	PKK 501	podnožje kopalne kadi za vgradnjo podnožje kupaonske kade za ugradnju	3838987 764878	29,00
	Zidni montažni set Zidni montažni set	za kopalne in tuš kadi za vgradnjo za kupaonske i tuš kade za ugradnju	3838987 704362	12,00
	Montažni set za oblogo /magnet Montažni set za oblogo / magnet	za kopalne kadi (v primeru dodatne kratke obloge) / za kupaonske kade (u primeru dodatne kratke obloge)	3838987 590750	29,00
	Suhomontažna zaključna letev Završna letva u sistemu suhe montaže	karton 25 kosov / karton 25 komada (Cena za kos / Cijena na komad 32,00 EUR)	3838987 903116	800,00
	Servisno prezračevalni pokrov z rešetko Servisno ventilacijski pokrov s rešetkom	za masažne kadi za vgradnjo (45x45 cm) za masažne kade za ugradnju (45x45 cm)	3838987 534808	95,00
	ANTI-SLIP PREMAZ	protizdrsni premaz za kopalne kadi protiv klizni premaz za kupaonske kade (min. kol. 10 kos)		70,00
	Specialno čistilo KOLPA SAN Specialno sredstvo za čišćenje	karton 20 kosov / karton 20 komada (Cena za kos / Cijena na komad 6,50 EUR)	3838987 747291	130,00
	Specialno čistilo ECO SAN Specialno sredstvo za čišćenje	karton 20 kosov / karton 20 komada (Cena za kos / Cijena na komad 5,70 EUR)	3838987 572220	114,00



Kopalne in masažne kadi

Kade za kupanje i masažne kade















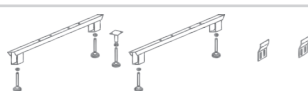

Program:**kolpa·san**
BY KOLPA

Model	Naziv in dimenzija izdelka Naziv i dimenzije produkta	Opis Opis	EAN koda EAN koda	Cena EUR Cijena EUR
Adam & Eva 195x125				
	Adam & Eva 195x125	kopalna kad za vgradnjo kada za ugradnju	3838987 593201	585,00
	Adam & Eva 195x125/20	kopalna kad z oblogo kada s oblogom	3838987 593218	1.110,00
	Vodni masažni sistem I. Vodeni masažni sistem I. PNEVMATSKI Adam & Eva 195x125	z oblogo s oblogom z oblogo + mikrošobe s oblogom + mikromlaznice	3838987 576655 3838987 576662	1.911,00 2.475,00
	Kombinirani (vodni in zračni) masažni sistem / Kombinirani (vodeni i zračni) masažni sistem ELEKTRONSKI Adam & Eva 195x125	z oblogo s oblogom z oblogo + mikrošobe s oblogom + mikromlaznice	3838987 576679 3838987 576686	3.188,00 3.754,00
	Vital masažni sistem Vital masažni sistem ELEKTRONSKI Adam & Eva 195x125	z oblogo + mikrošobe s oblogom + mikromlaznice	3838987 576693	4.808,00
Vgradnja mikrošob v kad Ugradnja mikromlaznica u kadu Adam & Eva 195x125				
	Prikaz vgradnje mikrošob Prikaz ugradnje mikromlaznica Adam & Eva 195x125			

Kopalne in masažne kadi

Kade za kupanje i masažne kade

Program:**kolpa·san**
BY KOLPA





Model	Naziv in dimenzija izdelka Naziv i dimenzije produkta	Opis Opis	EAN koda EAN koda	Cena EUR Cijena EUR
Dodatki za / Dodaci za Adam & Eva 195x125				
	WATERFALL 	enoročna armatura s tuš ročico in izlivom / jednoručna armatura s tuš ručicom i izlivom	3838987 734543	590,00
	GEYSER 	enoročna arm. s tuš ročico in polnilno /odlivno prelivno gar. za polnjenje kadi jednoručna arm. s tuš ručicom i priljev/odljev prelivnom garnituroom za punjenje kada	3838987 506287	633,00
	RAINDROP 	enoročna armatura s tuš ročico in izlivom / jednoručna armatura s tuš ručicom i izlivom	3838987 726500	620,00
	UP&DOWN, WHITE	prelivna garnitura s sifonom, bela prelivna garnitura sa sifonom, bijela	3838987 922759	65,00
	PAL 650, CHR	prelivna garnitura s sifonom, krom prelivna garnitura sa sifonom, krom	3838987 746270	58,00
	HEADREST COAST	vzglavnik naslon za glavu	3838987 593928	108,00
	PKK 800	podnožje kopalne kadi za vgradnjo podnožje kupaonske kade za ugradnju	3838987 795100	49,00
	Zidni montažni set Zidni montažni set	za kopalne in tuš kadi za vgradnjo za kupaonske i tuš kade za ugradnju	3838987 704362	12,00
	Montažni set za oblogo /magnet Montažni set za oblogo / magnet	za kopalne kadi (v primeru dodatne kratke obloge) / za kupaonske kade (u primeru dodatne kratke obloge)	3838987 590750	29,00
	Suhomontažna zaključna letva Završna letva u sistemu suhe montaže	karton 25 kosov / karton 25 komada (Cena za kos / Cijena na komad 32,00 EUR)	3838987 903116	800,00
	Chromoterapia (CTL) Chromoterapia (CTL)	2 LED lučki s samostojno tipkovnico 2 LED svjetla sa samostalnom tipkovnicom		401,00
	Dve dodatni mikro šobi Dvije dodatne mikro mlaznice	za masažo stopal (kpl) za masažu stopala (kpl)		64,00
	Servisno prezračevalni pokrov z rešetko Servisno ventilacijski pokrov s rešetkom	za masažne kadi za vgradnjo (45x45 cm) za masažne kade za ugradnju (45x45 cm)	3838987 534808	95,00
	ANTI-SLIP PREMAZ	protizdrsni premaz za kopalne kadi protiv klizni premaz za kupaonske kade (min. kol. 10 kos)		70,00
	Specialno čistilo KOLPA SAN Specialno sredstvo za čišćenje	karton 20 kosov / karton 20 komada (Cena za kos / Cijena na komad 6,50 EUR)	3838987 747291	130,00
	Specialno čistilo ECO SAN Specialno sredstvo za čišćenje	karton 20 kosov / karton 20 komada (Cena za kos / Cijena na komad 5,70 EUR)	3838987 572220	114,00
	Čistilo za masažne sisteme Sredstvo za čišćenje masažnih sistema	karton 10 kosov / karton 10 komada (Cena za kos / Cijena na komad 8,20 EUR)	3838987 747277	82,00

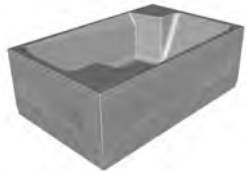

Kopalne in masažne kadi

Kade za kupanje i masažne kade

















Program:**kolpa·san**
BY KOLPA

Model	Naziv in dimenzija izdelka Naziv i dimenzije produkta	Opis Opis	EAN koda EAN koda	Cena EUR Cijena EUR
Nabucco 190x120				
	Nabucco 190x120	kopalna kad za vgradnjo kada za ugradnju	3838987 740360	610,00
	Nabucco 190/0	kopalna kad z oblogo kada s oblogom	3838987 787419	1.085,00
	Vodni masažni sistem I. Vodeni masažni sistem I. PNEVMATSKI Nabucco 190x120	z oblogo s oblogom z oblogo + mikrošobe s oblogom + mikromlaznice	3838987 794783 3838987 913276	1.873,00 2.437,00
	Kombinirani (vodni in zračni) masažni sistem / Kombinirani (vodeni i zračni) masažni sistem ELEKTRONSKI Nabucco 190x120	z oblogo s oblogom z oblogo + mikrošobe s oblogom + mikromlaznice	3838987 960034 3838987 718758	3.151,00 3.717,00
	Vital masažni sistem Vital masažni sistem ELEKTRONSKI Nabucco 190x120	z oblogo + mikrošobe s oblogom + mikromlaznice	3838987 571698	4.768,00
Vgradnja mikrošob v kad Ugradnja mikromlaznica u kadu Nabucco 190x120				
	Prikaz vgradnje mikrošob Prikaz ugradnje mikromlaznica Nabucco 190x120			

Kopalne in masažne kadi
Kade za kupanje i masažne kade

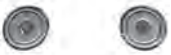
Program:

kolpa·san
BY KOLPA









Model	Naziv in dimenzija izdelka Naziv i dimenzije produkta	Opis Opis	EAN koda EAN koda	Cena EUR Cijena EUR
Dodatki za / Dodaci za Nabucco 190x120				
	WATERFALL 	enoročna armatura s tuš ročico in izlivom / jednoručna armatura s tuš ručicom i izljevom	3838987 734543	590,00
	GEYSER 	enoročna arm. s tuš ročico in polnilno /odlivno prelivno gar. za polnjenje kadi jednoručna arm. s tuš ručicom i priljev/odljev prelivnom garnituroom za punjenje kada	3838987 506287	633,00
	RAINDROP 	enoročna armatura s tuš ročico in izlivom / jednoručna armatura s tuš ručicom i izljevom	3838987 726500	620,00
	UP&DOWN, WHITE	prelivna garnitura s sifonom, bela prelivna garnitura sa sifonom, bijela	3838987 922759	65,00
	PAL 650, CHR	prelivna garnitura s sifonom, krom prelivna garnitura sa sifonom, krom	3838987 746270	58,00
	HEADREST SOFT	vzglavnik naslon za glavu	3838987 593942	83,00
	HEADREST COAST		3838987 593928	108,00
	PKK 800	podnožje kopalne kadi za vgradnjo podnožje kupaonske kade za ugradnju	3838987 795100	49,00
	Zidni montažni set Zidni montažni set	za kopalne in tuš kadi za vgradnjo za kupaonske i tuš kade za ugradnju	3838987 704362	12,00
	Montažni set za oblogo /magnet Montažni set za oblogo / magnet	za kopalne kadi (v primeru dodatne kratke obloge) / za kupaonske kade (u primeru dodatne kratke obloge)	3838987 590750	29,00
	Suhomontažna zaključna letev Završna letva u sistemu suhe montaže	karton 25 kosov / karton 25 komada (Cena za kos / Cijena na komad 32,00 EUR)	3838987 903116	800,00
	Chromoterapia (CTL) Chromoterapia (CTL)	2 LED lučki s samostojno tipkovnicom 2 LED svjetla sa samostalnom tipkovnicom		401,00
	Dve dodatni mikro šobi Dvije dodatne mikro mlaznice	za masažo stopal (kpl) za masažu stopala (kpl)		64,00
	Servisno prezračevalni pokrov z rešetko Servisno ventilacijski pokrov s rešetkom	za masažne kadi za vgradnjo (45x45 cm) za masažne kade za ugradnju (45x45 cm)	3838987 534808	95,00
	ANTI-SLIP PREMAZ	protizdrsni premaz za kopalne kadi protiv klizni premaz za kupaonske kade (min. kol. 10 kos)		70,00
	Specialno čistilo KOLPA SAN Specialno sredstvo za čišćenje	karton 20 kosov / karton 20 komada (Cena za kos / Cijena na komad 6,50 EUR)	3838987 747291	130,00
	Specialno čistilo ECO SAN Specialno sredstvo za čišćenje	karton 20 kosov / karton 20 komada (Cena za kos / Cijena na komad 5,70 EUR)	3838987 572220	114,00
	Čistilo za masažne sisteme Sredstvo za čišćenje masažnih sistema	karton 10 kosov / karton 10 komada (Cena za kos / Cijena na komad 8,20 EUR)	3838987 747277	82,00



Kopalne in masažne kadi

Kade za kupanje i masažne kade











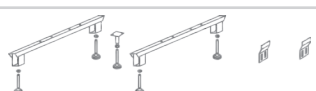

Program:**kolpa·san**
BY KOLPA

Model	Naziv in dimenzija izdelka Naziv i dimenzije produkta	Opis Opis	EAN koda EAN koda	Cena EUR Cijena EUR
Elektra 190x90				
	Elektra 190x90	kopalna kad za vgradnjo kada za ugradnju	3838987 740629	449,00
	A 190/63	dolga obloga duga obloga	3838987 565468	91,00
	A 90/63	kratka obloga kratka obloga	3838987 565413	58,00
	CM 180-200	podnožje kopalne kadi za oblogo podnožje kupaonske kade za oblogu	3838987 573012	125,00
	Vodni masažni sistem I. Vodeni masažni sistem I. PNEVMATSKI Elektra 190x90	z oblogo s oblogom	3838987 703334	1.525,00
		z oblogo + mikrošobe s oblogom + mikromlaznice	3838987 703358	2.088,00
	Kombinirani (vodni in zračni) masažni sistem / Kombinirani (vodeni i zračni) masažni sistem ELEKTRONSKI Elektra 190x90	z oblogo s oblogom	3838987 991397	2.799,00
		z oblogo + mikrošobe s oblogom + mikromlaznice	3838987 591276	3.366,00
	Vital masažni sistem Vital masažni sistem ELEKTRONSKI Elektra 190x90	z oblogo + mikrošobe s oblogom + mikromlaznice	3838987 703471	4.418,00
Vgradnja mikrošob v kad Ugradnja mikromlaznica u kadu Elektra 190x90				
	Prikaz vgradnje mikrošob Prikaz ugradnje mikromlaznica Elektra 190x90			

Kopalne in masažne kadi

Kade za kupanje i masažne kade

Program:**kolpa·san**
BY KOLPA









Model	Naziv in dimenzija izdelka Naziv i dimenzije produkta	Opis Opis	EAN koda EAN koda	Cena EUR Cijena EUR
Dodatki za / Dodaci za Elektra 190x90				
	UP&DOWN, WHITE	prelivna garnitura s sifonom, bela preljevna garnitura sa sifonom, bijela	3838987 922759	65,00
	PAL 650, CHR	prelivna garnitura s sifonom, krom preljevna garnitura sa sifonom, krom	3838987 746270	58,00
	HEADREST SOFT	vzglavnik naslon za glavu	3838987 593942	83,00
	HEADREST COAST		3838987 593928	108,00
	PKK 800	podnožje kopalne kadi za vgradnjo podnožje kupaonske kade za ugradnju	3838987 795100	49,00
	Zidni montažni set Zidni montažni set	za kopalne in tuš kadi za vgradnjo za kupaonske i tuš kade za ugradnju	3838987 704362	12,00
	Montažni set za oblogo /magnet Montažni set za oblogo / magnet	za kopalne kadi (v primeru dodatne kratke obloge) / za kupaonske kade (u primeru dodatne kratke obloge)	3838987 590750	29,00
	Suhomontažna zaključna letva Završna letva u sistemu suhe montaže	karton 25 kosov / karton 25 komada (Cena za kos / Cijena na komad 32,00 EUR)	3838987 903116	800,00
	Chromoterapia (CTL) Chromoterapia (CTL)	2 LED lučki s samostojno tipkovnico 2 LED svjetla sa samostalnom tipkovnicom		401,00
	Dve dodatni mikro šobi Dvije dodatne mikro mlaznice	za masažo stopal (kpl) za masažu stopala (kpl)		64,00
	Servisno prezračevalni pokrov z rešetko Servisno ventilacijski pokrov s rešetkom	za masažne kadi za vgradnjo (45x45 cm) za masažne kade za ugradnju (45x45 cm)	3838987 534808	95,00
	ANTI-SLIP PREMAZ	protizdrsni premaz za kopalne kadi protiv klizni premaz za kupaonske kade (min. kol. 10 kos)		70,00
	Specialno čistilo KOLPA SAN Specialno sredstvo za čišćenje	karton 20 kosov / karton 20 komada (Cena za kos / Cijena na komad 6,50 EUR)	3838987 747291	130,00
	Specialno čistilo ECO SAN Specialno sredstvo za čišćenje	karton 20 kosov / karton 20 komada (Cena za kos / Cijena na komad 5,70 EUR)	3838987 572220	114,00
	Čistilo za masažne sisteme Sredstvo za čišćenje masažnih sistema	karton 10 kosov / karton 10 komada (Cena za kos / Cijena na komad 8,20 EUR)	3838987 747277	82,00



Kopalne in masažne kadi

Kade za kupanje i masažne kade











Program:kolpa·san[®]
BY KOLPA

Model	Naziv in dimenzija izdelka Naziv i dimenzije produkta	Opis Opis	EAN koda EAN koda	Cena EUR Cijena EUR
Elektra 180x80				
	Elektra 180x80	kopalna kad za vgradnjo kupaonska kada za ugradnju	3838987 739135	373,00
	A 180/63	dolga obloga duga obloga	3838987 565215	77,00
	A 80/63	kratka obloga kratka obloga	3838987 565222	51,00
	CM 180-200	podnožje kopalne kadi za oblogo podnožje kupaonske kade za oblogu	3838987 573012	125,00
	Vodni masažni sistem I. Vodeni masažni sistem I. PNEVMATSKI Elektra 180x80	z oblogo s oblogom z oblogo + mikrošobe s oblogom + mikromlaznice	3838987 703075 3838987 703150	1.457,00 2.022,00
	Kombinirani (vodni in zračni) masažni sistem / Kombinirani (vodeni i zračni) masažni sistem ELEKTRONSKI Elektra 180x80	z oblogo s oblogom z oblogo + mikrošobe s oblogom + mikromlaznice	3838987 735366 3838987 706199	2.735,00 3.300,00
	Vital masažni sistem Vital masažni sistem ELEKTRONSKI Elektra 180x80	z oblogo + mikrošobe s oblogom + mikromlaznice	3838987 725442	4.351,00
Vgradnja mikrošob v kad Ugradnja mikromlaznica u kadu Elektra 180x80				
	Prikaz vgradnje mikrošob Prikaz ugradnje mikromlaznica Elektra 180x80			

Kopalne in masažne kadi

Kade za kupanje i masažne kade

Program:**kolpa·san**
BY KOLPA







Model	Naziv in dimenzija izdelka Naziv i dimenzije produkta	Opis Opis	EAN koda EAN koda	Cena EUR Cijena EUR
Dodatki za / Dodaci za Elektra 180x80				
	UP&DOWN, WHITE	prelivna garnitura s sifonom, bela prelivna garnitura sa sifonom, bijela	3838987 922759	65,00
	PAL 650, CHR	prelivna garnitura s sifonom, krom prelivna garnitura sa sifonom, krom	3838987 746270	58,00
	HEADREST SOFT	vzglavnik naslon za glavu	3838987 593942	83,00
	HEADREST COAST		3838987 593928	108,00
	PKK 501	podnožje kopalne kadi za vgradnjo podnožje kupaonske kade za ugradnju	3838987 764878	29,00
	Zidni montažni set Zidni montažni set	za kopalne in tuš kadi za vgradnjo za kupaonske i tuš kade za ugradnju	3838987 704362	12,00
	Montažni set za oblogo /magnet Montažni set za oblogo / magnet	za kopalne kadi (v primeru dodatne kratke obloge) / za kupaonske kade (u primeru dodatne kratke obloge)	3838987 590750	29,00
	Suhomontažna zaključna letev Završna letva u sistemu suhe montaže	karton 25 kosov / karton 25 komada (Cena za kos / Cijena na komad 32,00 EUR)	3838987 903116	800,00
	Chromoterapia (CTL) Chromoterapia (CTL)	2 LED lučki s samostojno tipkovnico 2 LED svjetla sa samostalnom tipkovnicom		401,00
	Dve dodatni mikro šobi Dvije dodatne mikro mlaznice	za masažo stopal (kpl) za masažu stopala (kpl)		64,00
	Servisno prezračevalni pokrov z rešetko Servisno ventilacijski pokrov s rešetkom	za masažne kadi za vgradnjo (45x45 cm) za masažne kade za ugradnju (45x45 cm)	3838987 534808	95,00
	ANTI-SLIP PREMAZ	protizdrsni premaz za kopalne kadi protiv klizni premaz za kupaonske kade (min. kol. 10 kos)		70,00
	Specialno čistilo KOLPA SAN Specialno sredstvo za čišćenje	karton 20 kosov / karton 20 komada (Cena za kos / Cijena na komad 6,50 EUR)	3838987 747291	130,00
	Specialno čistilo ECO SAN Specialno sredstvo za čišćenje	karton 20 kosov / karton 20 komada (Cena za kos / Cijena na komad 5,70 EUR)	3838987 572220	114,00
	Čistilo za masažne sisteme Sredstvo za čišćenje masažnih sistema	karton 10 kosov / karton 10 komada (Cena za kos / Cijena na komad 8,20 EUR)	3838987 747277	82,00



Kopalne in masažne kadi
Kade za kupanje i masažne kade

Program:



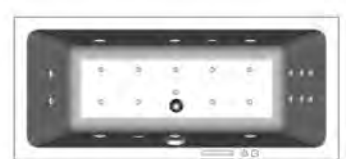
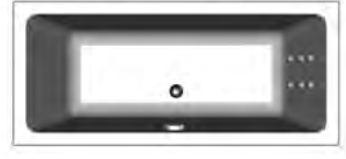









kolpa·san
BY KOLPA

Model	Naziv in dimenzija izdelka Naziv i dimenzije produkta	Opis Opis	EAN koda EAN koda	Cena EUR Cijena EUR
Elektra 170x80				
	Elektra 170x80	kopalna kad za vgradnjo kada za ugradnju	3838987 740667	362,00
	A 170/63	dolga obloga duga obloga	3838987 565376	77,00
	A 80/63	kratka obloga kratka obloga	3838987 565222	51,00
	CM 160-170	podnožje kopalne kadi za oblogo podnožje kupaonske kade za oblogu	3838987 573005	125,00
	Vodni masažni sistem I. Vodeni masažni sistem I. PNEVMATSKI Elektra 170x80	z oblogo s oblogom z oblogo + mikrošobe s oblogom + mikromlaznice	3838987 702771 3838987 702801	1.446,00 2.012,00
	Kombinirani (vodni in zračni) masažni sistem / Kombinirani (vodeni i zračni) masažni sistem ELEKTRONSKI Elektra 170x80	z oblogo s oblogom z oblogo + mikrošobe s oblogom + mikromlaznice	3838987 591207 3838987 591214	2.724,00 3.289,00
	Vital masažni sistem Vital masažni sistem ELEKTRONSKI Elektra 170x80	z oblogo + mikrošobe s oblogom + mikromlaznice	3838987 702931	4.341,00
Vgradnja mikrošob v kad Ugradnja mikromlaznica u kadu Elektra 170x80				
	Prikaz vgradnje mikrošob Prikaz ugradnje mikromlaznica Elektra 170x80			

Kopalne in masažne kadi

Kade za kupanje i masažne kade

Program:**kolpa·san**
BY KOLPA









Model	Naziv in dimenzija izdelka Naziv i dimenzije produkta	Opis Opis	EAN koda EAN koda	Cena EUR Cijena EUR
Dodatki za / Dodaci za Elektra 170x80	 UP&DOWN, WHITE	prelivna garnitura s sifonom, bela preljevna garnitura sa sifonom, bijela	3838987 922759	65,00
	 PAL 650, CHR	prelivna garnitura s sifonom, krom preljevna garnitura sa sifonom, krom	3838987 746270	58,00
	HEADREST SOFT	vzglavnik naslon za glavu	3838987 593942	83,00
	HEADREST COAST		3838987 593928	108,00
	PKK 501	podnožje kopalne kadi za vgradnjo podnožje kupaonske kade za ugradnju	3838987 764878	29,00
	Zidni montažni set Zidni montažni set	za kopalne in tuš kadi za vgradnjo za kupaonske i tuš kade za ugradnju	3838987 704362	12,00
	Montažni set za oblogo / magnet Montažni set za oblogu / magnet	za kopalne kadi (v primeru dodatne kratke obloge) / za kupaonske kade (u primeru dodatne kratke obloge)	3838987 590750	29,00
	Suhomontažna zaključna letev Završna letva u sistemu suhe montaže	karton 25 kosov / karton 25 komada (Cena za kos / Cijena na komad 32,00 EUR)	3838987 903116	800,00
	Chromoterapia (CTL) Chromoterapia (CTL)	2 LED lučki s samostojno tipkovnicom 2 LED svjetla sa samostalnom tipkovnicom		401,00
	Dve dodatni mikro šobi Dvije dodatne mikro mlaznice	za masažo stopal (kpl) za masažu stopala (kpl)		64,00
	Servisno prezračevalni pokrov z rešetko Servisno ventilacijski pokrov s rešetkom	za masažne kadi za vgradnjo (45x45 cm) za masažne kade za ugradnju (45x45 cm)	3838987 534808	95,00
	ANTI-SLIP PREMAZ	protizdrsni premaz za kopalne kadi protiv klizni premaz za kupaonske kade (min. kol. 10 kos)		70,00
	Specialno čistoilo KOLPA SAN Specialno sredstvo za čišćenje	karton 20 kosov / karton 20 komada (Cena za kos / Cijena na komad 6,50 EUR)	3838987 747291	130,00
	Specialno čistoilo ECO SAN Specialno sredstvo za čišćenje	karton 20 kosov / karton 20 komada (Cena za kos / Cijena na komad 5,70 EUR)	3838987 572220	114,00
	Čistilo za masažne sisteme Sredstvo za čišćenje masažnih sistema	karton 10 kosov / karton 10 komada (Cena za kos / Cijena na komad 8,20 EUR)	3838987 747277	82,00



Kopalne in masažne kadi

Kade za kupanje i masažne kade

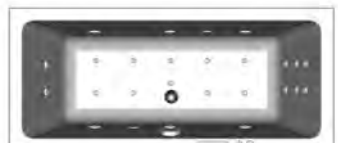











Program:**kolpa·san**
BY KOLPA

Model	Naziv in dimenzija izdelka Naziv i dimenzije produkta	Opis Opis	EAN koda EAN koda	Cena EUR Cijena EUR
Elektra 170x75				
	Elektra 170x75	kopalna kad za vgradnjo kada za ugradnju	3838987 740674	343,00
	A 170/63	dolga obloga duga obloga	3838987 565376	77,00
	A 75/63	kratka obloga kratka obloga	3838987 565369	47,00
	CM 160-170	podnožje kopalne kadi za oblogo podnožje kupaonske kade za oblogu	3838987 573005	125,00
	Vodni masažni sistem I. Vodeni masažni sistem I. PNEVMATSKI Elektra 170x75	z oblogo s oblogom z oblogo + mikrošobe s oblogom + mikromlaznice	3838987 931454 3838987 931478	1.434,00 2.000,00
	Kombinirani (vodni in zračni) masažni sistem / Kombinirani (vodeni i zračni) masažni sistem ELEKTRONSKI Elektra 170x75	z oblogo s oblogom z oblogo + mikrošobe s oblogom + mikromlaznice	3838987 757696 3838987 952534	2.712,00 3.279,00
	Vital masažni sistem Vital masažni sistem ELEKTRONSKI Elektra 170x75	z oblogo + mikrošobe s oblogom + mikromlaznice	3838987 950752	4.331,00
Vgradnja mikrošob v kad Ugradnja mikromlaznica u kadu Elektra 170x75				
	Prikaz vgradnje mikrošob Prikaz ugradnje mikromlaznica Elektra 170x75			

Kopalne in masažne kadi

Kade za kupanje i masažne kade

Program:**kolpa·san**
BY KOLPA





Model	Naziv in dimenzija izdelka Naziv i dimenzije produkta	Opis Opis	EAN koda EAN koda	Cena EUR Cijena EUR
Dodatki za / Dodaci za Elektra 170x75	 UP&DOWN, WHITE	prelivna garnitura s sifonom, bela prelivna garnitura sa sifonom, bijela	3838987 922759	65,00
	 PAL 650, CHR	prelivna garnitura s sifonom, krom prelivna garnitura sa sifonom, krom	3838987 746270	58,00
	HEADREST SOFT	vzglavnik naslon za glavu	3838987 593942	83,00
	HEADREST COAST		3838987 593928	108,00
	SKK	sedež za kopalno kad sjedalo za kupaonsku kadu	3838987 950943	106,00
	PKK 501	podnožje kopalne kadi za vgradnjo podnožje kupaonske kade za ugradnju	3838987 764878	29,00
	Zidni montažni set Zidni montažni set	za kopalne in tuš kadi za vgradnjo za kupaonske i tuš kade za ugradnju	3838987 704362	12,00
	Montažni set za oblogo / magnet Montažni set za oblogo / magnet	za kopalne kadi (v primeru dodatne kratke obloge) / za kupaonske kade (u primeru dodatne kratke obloge)	3838987 590750	29,00
	Suhomontažna zaključna letva Završna letva u sistemu suhe montaže	karton 25 kosov / karton 25 komada (Cena za kos / Cijena na komad 32,00 EUR)	3838987 903116	800,00
	Chromoterapia (CTL) Chromoterapia (CTL)	2 LED lučki s samostojno tipkovnico 2 LED svjetla sa samostalnom tipkovnicom		401,00
	Dve dodatni mikro šobi Dvije dodatne mikro mlaznice	za masažo stopal (kpl) za masažu stopala (kpl)		64,00
	Servisno prezračevalni pokrov z rešetko Servisno ventilacijski pokrov s rešetkom	za masažne kadi za vgradnjo (45x45 cm) za masažne kade za ugradnju (45x45 cm)	3838987 534808	95,00
	ANTI-SLIP PREMAZ	protizdrsni premaz za kopalne kadi protiv klizni premaz za kupaonske kade (min. kol. 10 kos)		70,00
	Specialno čistilo KOLPA SAN Specialno sredstvo za čiščenje	karton 20 kosov / karton 20 komada (Cena za kos / Cijena na komad 6,50 EUR)	3838987 747291	130,00
	Specialno čistilo ECO SAN Specialno sredstvo za čiščenje	karton 20 kosov / karton 20 komada (Cena za kos / Cijena na komad 5,70 EUR)	3838987 572220	114,00
	Čistilo za masažne sisteme Sredstvo za čiščenje masažnih sistema	karton 10 kosov / karton 10 komada (Cena za kos / Cijena na komad 8,20 EUR)	3838987 747277	82,00



Kopalne in masažne kadi
Kade za kupanje i masažne kade

Program:











kolpa·san
BY KOLPA

Model	Naziv in dimenzija izdelka Naziv i dimenzije produkta	Opis Opis	EAN koda EAN koda	Cena EUR Cijena EUR
Elektra 170x70				
	Elektra 170x70	kopalna kad za vgradnjo kada za ugradnju	3838987 740681	337,00
	A 170/63	dolga obloga duga obloga	3838987 565376	77,00
	A 70/63	kratka obloga kratka obloga	3838987 565390	47,00
	CM 160-170	podnožje kopalne kadi za oblogo podnožje kupaonske kade za oblogu	3838987 573005	125,00

Kopalne in masažne kadi

Kade za kupanje i masažne kade

Program:kolpa·san[®]







Model	Naziv in dimenzija izdelka Naziv i dimenzije produkta	Opis Opis	EAN koda EAN koda	Cena EUR Cijena EUR
Dodatki za / Dodaci za Elektra 170x70	 UP&DOWN, WHITE	prelivna garnitura s sifonom, bela prelivna garnitura sa sifonom, bijela	3838987 922759	65,00
	 PAL 650, CHR	prelivna garnitura s sifonom, krom prelivna garnitura sa sifonom, krom	3838987 746270	58,00
	HEADREST SOFT	vzglavnik naslon za glavu	3838987 593942	83,00
	HEADREST COAST		3838987 593928	108,00
	SKK	sedež za kopalno kad sjedalo za kupaonsku kadu	3838987 950943	106,00
	PKK 501	podnožje kopalne kadi za vgradnjo podnožje kupaonske kade za ugradnju	3838987 764878	29,00
	Zidni montažni set Zidni montažni set	za kopalne in tuš kadi za vgradnjo za kupaonske i tuš kade za ugradnju	3838987 704362	12,00
	Montažni set za oblogo / magnet Montažni set za oblogu / magnet	za kopalne kadi (v primeru dodatne kratke obloge) / za kupaonske kade (u primeru dodatne kratke obloge)	3838987 590750	29,00
	Suhomontažna zaključna letva Završna letva u sistemu suhe montaže	karton 25 kosov / karton 25 komada (Cena za kos / Cijena na komad 32,00 EUR)	3838987 903116	800,00
	Servisno prezračevalni pokrov z rešetko Servisno ventilacijski pokrov s rešetkom	za kopalne kadi za vgradnjo (45x45 cm) za kupaonske kade za ugradnju (45x45 cm)	3838987 534808	95,00
	ANTI-SLIP PREMAZ	protizdrsni premaz za kopalne kadi protiv klizni premaz za kupaonske kade (min. kol. 10 kos)		70,00
	Specialno čistilo KOLPA SAN Specialno sredstvo za čišćenje	karton 20 kosov / karton 20 komada (Cena za kos / Cijena na komad 6,50 EUR)	3838987 747291	130,00
	Specialno čistilo ECO SAN Specialno sredstvo za čišćenje	karton 20 kosov / karton 20 komada (Cena za kos / Cijena na komad 5,70 EUR)	3838987 572220	114,00



Kopalne in masažne kadi
Kade za kupanje i masažne kade

Program:



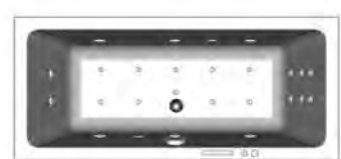
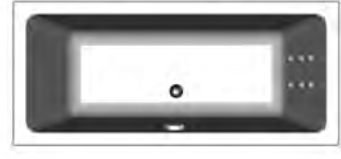









kolpa·san
BY KOLPA

Model	Naziv in dimenzija izdelka Naziv i dimenzije produkta	Opis Opis	EAN koda EAN koda	Cena EUR Cijena EUR
Elektra 160x75				
	Elektra 160x75	kopalna kad za vgradnjo kada za ugradnju	3838987 740704	337,00
	A 160/63	dolga obloga duga obloga	3838987 565444	77,00
	A 75/63	kratka obloga kratka obloga	3838987 565369	47,00
	CM 160-170	podnožje kopalne kadi za oblogo podnožje kupaonske kade za oblogu	3838987 573005	125,00
	Vodni masažni sistem I. Vodeni masažni sistem I. PNEVMATSKI Elektra 160x75	z oblogo s oblogom	3838987 931683	1.428,00
		z oblogo + mikrošobe s oblogom + mikromlaznice	3838987 931720	1.994,00
	Kombinirani (vodni in zračni) masažni sistem / Kombinirani (vodeni i zračni) masažni sistem ELEKTRONSKI Elektra 160x75	z oblogo s oblogom	3838987 591146	2.707,00
		z oblogo + mikrošobe s oblogom + mikromlaznice	3838987 591153	3.273,00
	Vital masažni sistem Vital masažni sistem ELEKTRONSKI Elektra 160x75	z oblogo + mikrošobe s oblogom + mikromlaznice	3838987 950776	4.324,00
Vgradnja mikrošob v kad Ugradnja mikromlaznica u kadu Elektra 160x75				
	Prikaz vgradnje mikrošob Prikaz ugradnje mikromlaznica Elektra 160x75			

Kopalne in masažne kadi

Kade za kupanje i masažne kade

Program:**kolpa·san**
BY KOLPA



Model	Naziv in dimenzija izdelka Naziv i dimenzije produkta	Opis Opis	EAN koda EAN koda	Cena EUR Cijena EUR
Dodatki za / Dodaci za Elektra 160x75	 UP&DOWN, WHITE	prelivna garnitura s sifonom, bela prelivna garnitura sa sifonom, bijela	3838987 922759	65,00
	 PAL 650, CHR	prelivna garnitura s sifonom, krom prelivna garnitura sa sifonom, krom	3838987 746270	58,00
	HEADREST SOFT	vzglavnik naslon za glavu	3838987 593942	83,00
	HEADREST COAST		3838987 593928	108,00
	SKK	sedež za kopalno kad sjedalo za kupaonsku kado	3838987 950943	106,00
	PKK 501	podnožje kopalne kadi za vgradnjo podnožje kupaonske kade za ugradnju	3838987 764878	29,00
	Zidni montažni set Zidni montažni set	za kopalne in tuš kadi za vgradnjo za kupaonske i tuš kade za ugradnju	3838987 704362	12,00
	Montažni set za oblogo / magnet Montažni set za oblogu / magnet	za kopalne kadi (v primeru dodatne kratke obloge) / za kupaonske kade (u primeru dodatne kratke obloge)	3838987 590750	29,00
	Suhomontažna zaključna letva Završna letva u sistemu suhe montaže	karton 25 kosov / karton 25 komada (Cena za kos / Cijena na komad 32,00 EUR)	3838987 903116	800,00
	Chromotherapia (CTL) Chromotherapia (CTL)	2 LED lučki s samostojno tipkovnico 2 LED svjetla sa samostalnom tipkovnicom		401,00
	Dve dodatni mikro šobi Dvije dodatne mikro mlaznice	za masažo stopal (kpl) za masažu stopala (kpl)		64,00
	Servisno prezračevalni pokrov z rešetko Servisno ventilacijski pokrov s rešetkom	za masažne kadi za vgradnjo (45x45 cm) za masažne kade za ugradnju (45x45 cm)	3838987 534808	95,00
	ANTI-SLIP PREMAZ	protizdrsni premaz za kopalne kadi protiv klizni premaz za kupaonske kade (min. kol. 10 kos)		70,00
	Specialno čištilo KOLPA SAN Specialno sredstvo za čišćenje	karton 20 kosov / karton 20 komada (Cena za kos / Cijena na komad 6,50 EUR)	3838987 747291	130,00
	Specialno čištilo ECO SAN Specialno sredstvo za čišćenje	karton 20 kosov / karton 20 komada (Cena za kos / Cijena na komad 5,70 EUR)	3838987 572220	114,00
	Čistilo za masažne sisteme Sredstvo za čišćenje masažnih sistema	karton 10 kosov / karton 10 komada (Cena za kos / Cijena na komad 8,20 EUR)	3838987 747277	82,00



Kopalne in masažne kadi

Kade za kupanje i masažne kade



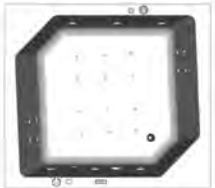
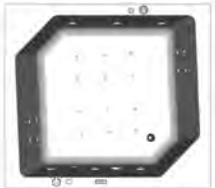
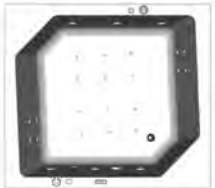
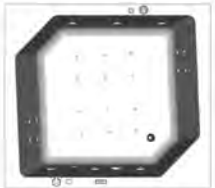
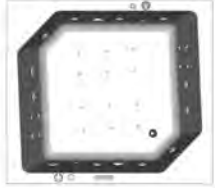
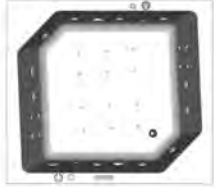
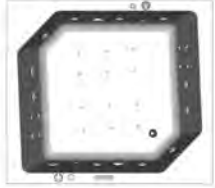











Program:**kolpa·san**
BY KOLPA

Model	Naziv in dimenzija izdelka Naziv i dimenzije produkta	Opis Opis	EAN koda EAN koda	Cena EUR Cijena EUR
Samson 180x160				
	Samson 180x160	kopalna kad za vgradnjo kada za ugradnju	3838987 740346	723,00
	Samson 180x160/20	kopalna kad z dvema oblogama kupaonska kada s dvije obloge	3838987 710004	1.215,00
	Samson 180x160/40	kopalna kad s štirim oblogami kupaonska kada sa četiri obloge	3838987 722250	1.528,00
	Kombinirani (vodni in zračni) masažni sistem Kombinirani (vodeni i zračni) masažni sistem ELEKTRONSKI Samson 180x160	masažna kopalna kad za vgradnjo masažna kada za ugradnju	3838987 731344	3.744,00
	Samson 180/20	masažna kad z dvema oblogama masažna kada sa dvije obloge	3838987 995470	4.002,00
	Samson 180/40	masažna kad s štirim oblogami masažna kada sa četiri obloge	3838987 995487	4.141,00
	Vital masažni sistem + mikrošobe Vital masažni sistem ELEKTRONSKI Samson 180x160	masažna kopalna kad za vgradnjo masažna kada za ugradnju	3838987 513933	4.955,00
	Samson 180/20	masažna kad z dvema oblogama masažna kada sa dvije obloge	3838987 513902	5.105,00
	Samson 180/40	masažna kad s štirim oblogami masažna kada sa četiri obloge	3838987 513896	5.303,00

Kopalne in masažne kadi

Kade za kupanje i masažne kade

Program:**kolpa·san**
BY KOLPA







Model	Naziv in dimenzija izdelka Naziv i dimenzije produkta	Opis Opis	EAN koda EAN koda	Cena EUR Cijena EUR
Dodatki za / Dodaci za Samson 180x160				
	WATERFALL 	enoročna armatura s tuš ročico in izlivom / jednoručna armatura s tuš ručicom i izljevom	3838987 734543	590,00
	GEYSER 	enoročna arm. s tuš ročico in polnilno /odlivno prelivno gar. za polnjenje kadi jednoručna arm. s tuš ručicom i priljev/odljev prelivnom garnituroom za punjenje kada	3838987 506287	633,00
	RAINDROP 	enoročna armatura s tuš ročico in izlivom / jednoručna armatura s tuš ručicom i izljevom	3838987 726500	620,00
	UP&DOWN, WHITE	prelivna garnitura s sifonom, bela prelivna garnitura sa sifonom, bijela	3838987 922759	65,00
	PAL 650, CHR	prelivna garnitura s sifonom, krom prelivna garnitura sa sifonom, krom	3838987 746270	58,00
	2x PKK 800	podnožje kopalne kadi za vgradnjo podnožje kupaonske kade za ugradnju cena za 1 kos / cijena za 1 komad	2x 3838987 795100	2x 49,00
	HEADREST SOFT	vzglavnik naslon za glavu	3838987 593942	83,00
	HEADREST COAST		3838987 593928	108,00
	Zidni montažni set Zidni montažni set	za kopalne in tuš kadi za vgradnjo za kupaonske i tuš kade za ugradnju	3838987 704362	12,00
	Suhomontažna zaključna letev Završna letva u sistemu suhe montaže	karton 25 kosov / karton 25 komada (Cena za kos / Cijena na komad 32,00 EUR)	3838987 903116	800,00
	Servisno prezračevalni pokrov z rešetko Servisno ventilacijski pokrov s rešetkom	za masažne kadi za vgradnjo (45x45 cm) za masažne kade za ugradnju (45x45 cm)	3838987 534808	95,00
	ANTI-SLIP PREMAZ	protizdrsnni premaz za kopalne kadi protiv klizni premaz za kupaonske kade (min. kol. 10 kos)		70,00
	Specialno čištilo KOLPA SAN Specialno sredstvo za čišćenje	karton 20 kosov / karton 20 komada (Cena za kos / Cijena na komad 6,50 EUR)	3838987 747291	130,00
	Specialno čištilo ECO SAN Specialno sredstvo za čišćenje	karton 20 kosov / karton 20 komada (Cena za kos / Cijena na komad 5,70 EUR)	3838987 572220	114,00
	Čištilo za masažne sisteme Sredstvo za čišćenje masažnih sistema	karton 10 kosov / karton 10 komada (Cena za kos / Cijena na komad 8,20 EUR)	3838987 747277	82,00



Kopalne in masažne kadi

Kade za kupanje i masažne kade

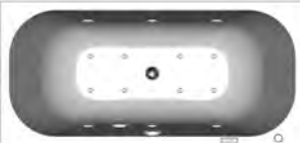















Program:**kolpa·san**
BY KOLPA

Model	Naziv in dimenzija izdelka Naziv i dimenzije produkta	Opis Opis	EAN koda EAN koda	Cena EUR Cijena EUR
Pandora bathtub 180x85				
	Pandora bathtub 180x85	kopalna kad za vgradnjo kada za ugradnju	3838987 593133	337,00
	A 180/63	dolga obloga duga obloga	3838987 565215	77,00
	A 85/63	kratka obloga kratka obloga	3838987 565475	51,00
	CM 180-200	podnožje kopalne kadi za oblogo podnožje kupaonske kade za oblogu	3838987 573012	125,00
	Vodni masažni sistem I. Vodeni masažni sistem I. PNEVMATSKI Pandora bathtub 180x85	z oblogo s oblogom	3838987 576594	1.424,00
		z oblogo + mikrošobe s oblogom + mikromlaznice	3838987 576600	1.989,00
	Kombinirani (vodni in zračni) masažni sistem / Kombinirani (vodeni i zračni) masažni sistem ELEKTRONSKI Pandora bathtub 180x85	z oblogo s oblogom	3838987 577034	2.702,00
		z oblogo + mikrošobe s oblogom + mikromlaznice	3838987 577058	3.266,00
Vgradnja mikrošob v kad Ugradnja mikromlaznica u kadu Pandora 180x85				
	Prikaz vgradnje mikrošob Prikaz ugradnje mikromlaznica Pandora bathtub 180x85			

Kopalne in masažne kadi
Kade za kupanje i masažne kade

Program:

kolpa·san
BY KOLPA







Model	Naziv in dimenzija izdelka Naziv i dimenzije produkta	Opis Opis	EAN koda EAN koda	Cena EUR Cijena EUR
Dodatki za / Dodaci za Pandora bathtub 180x85				
	WATERFALL 	enoročna armatura s tuš ročico in izlivom / jednoručna armatura s tuš ručicom i izljevom	3838987 734543	590,00
	GEYSER 	enoročna arm. s tuš ročico in polnilno /odlivno prelivno gar. za polnjenje kadi jednoručna arm. s tuš ručicom i priljev/odljev prelivnom garnituro za punjenje kada	3838987 506287	633,00
	RAINDROP 	enoročna armatura s tuš ročico in izlivom / jednoručna armatura s tuš ručicom i izljevom	3838987 726500	620,00
	UP&DOWN, WHITE	prelivna garnitura s sifonom, bela prelivna garnitura sa sifonom, bijela	3838987 922759	65,00
	PAL 650, CHR	prelivna garnitura s sifonom, krom prelivna garnitura sa sifonom, krom	3838987 746270	58,00
	HEADREST SOFT	vzglavnik naslon za glavu	3838987 593942	83,00
	HEADREST COAST		3838987 593928	108,00
	PKK 501	podnožje kopalne kadi za vgradnjo podnožje kupaonske kade za ugradnju	3838987 764878	29,00
	Zidni montažni set Zidni montažni set	za kopalne in tuš kadi za vgradnjo za kupaonske i tuš kade za ugradnju	3838987 704362	12,00
	Montažni set za oblogo /magnet Montažni set za oblogo / magnet	za kopalne kadi (v primeru dodatne kratke obloge) / za kupaonske kade (u primeru dodatne kratke obloge)	3838987 590750	29,00
	Suhomontažna zaključna letva Završna letva u sistemu suhe montaže	karton 25 kosov / karton 25 komada (Cena za kos / Cijena na komad 32,00 EUR)	3838987 903116	800,00
	Chromoterapia (CTL) Chromoterapia (CTL)	2 LED lučki s samostojno tipkovnico 2 LED svjetla sa samostalnom tipkovnicom		401,00
	Servisno prezračevalni pokrov z rešetko Servisno ventilacijski pokrov s rešetkom	za masažne kadi za vgradnjo (45x45 cm) za masažne kade za ugradnju (45x45 cm)	3838987 534808	95,00
	ANTI-SLIP PREMAZ	protizdrsni premaz za kopalne kadi protiv klizni premaz za kupaonske kade (min. kol. 10 kos)		70,00
	Specialno čištilo KOLPA SAN Specialno sredstvo za čišćenje	karton 20 kosov / karton 20 komada (Cena za kos / Cijena na komad 6,50 EUR)	3838987 747291	130,00
	Specialno čištilo ECO SAN Specialno sredstvo za čišćenje	karton 20 kosov / karton 20 komada (Cena za kos / Cijena na komad 5,70 EUR)	3838987 572220	114,00
	Čištilo za masažne sisteme Sredstvo za čišćenje masažnih sistema	karton 10 kosov / karton 10 komada (Cena za kos / Cijena na komad 8,20 EUR)	3838987 747277	82,00



Kopalne in masažne kadi

Kade za kupanje i masažne kade

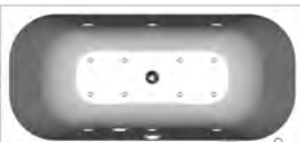















Program:**kolpa·san**
BY KOLPA

Model	Naziv in dimenzija izdelka Naziv i dimenzije produkta	Opis Opis	EAN koda EAN koda	Cena EUR Cijena EUR
Pandora bathtub 170x75				
	Pandora bathtub 170x75	kopalna kad za vgradnjo kada za ugradnju	3838987 593119	326,00
	A 170/63	dolga obloga duga obloga	3838987 565376	77,00
	A 75/63	kratka obloga kratka obloga	3838987 565369	47,00
	CM 160-170	podnožje kopalne kadi za oblogo podnožje kupaonske kade za oblogu	3838987 573005	125,00
	Vodni masažni sistem I. Vodeni masažni sistem I. <small>PNEVMATSKI</small> Pandora bathtub 170x75	z oblogo s oblogom z oblogo + mikrošobe s oblogom + mikromlaznice	3838987 576556 3838987 576563	1.414,00 1.978,00
	Kombinirani (vodni in zračni) masažni sistem / Kombinirani (vodeni i zračni) masažni sistem <small>ELEKTRONSKI</small> Pandora bathtub 170x75	z oblogo s oblogom z oblogo + mikrošobe s oblogom + mikromlaznice	3838987 577010 3838987 593195	2.691,00 3.256,00
Vgradnja mikrošob v kad Ugradnja mikromlaznica u kado Pandora 170x75				
	Prikaz vgradnje mikrošob Prikaz ugradnje mikromlaznica Pandora bathtub 170x75			

Kopalne in masažne kadi
Kade za kupanje i masažne kade

Program:

kolpa·san
BY KOLPA

Model	Naziv in dimenzija izdelka Naziv i dimenzije produkta	Opis Opis	EAN koda EAN koda	Cena EUR Cijena EUR
Dodatki za / Dodaci za Pandora bathtub 170x75				
	WATERFALL 	enoročna armatura s tuš ročico in izlivom / jednoručna armatura s tuš ručicom i izljevom	3838987 734543	590,00
	GEYSER 	enoročna arm. s tuš ročico in polnilno /odlivno prelivno gar. za polnjenje kadi jednoručna arm. s tuš ručicom i priljev/odljev prelivnom garnituroom za punjenje kada	3838987 506287	633,00
	RAINDROP 	enoročna armatura s tuš ročico in izlivom / jednoručna armatura s tuš ručicom i izljevom	3838987 726500	620,00
	UP&DOWN, WHITE	prelivna garnitura s sifonom, bela prelivna garnitura sa sifonom, bijela	3838987 922759	65,00
	PAL 650, CHR	prelivna garnitura s sifonom, krom prelivna garnitura sa sifonom, krom	3838987 746270	58,00
	HEADREST SOFT	vzglavnik naslon za glavu	3838987 593942	83,00
	HEADREST COAST		3838987 593928	108,00
	PKK 501	podnožje kopalne kadi za vgradnjo podnožje kupaonske kade za ugradnju	3838987 764878	29,00
	Zidni montažni set Zidni montažni set	za kopalne in tuš kadi za vgradnjo za kupaonske i tuš kade za ugradnju	3838987 704362	12,00
	Montažni set za oblogo /magnet Montažni set za oblogo / magnet	za kopalne kadi (v primeru dodatne kratke obloge) / za kupaonske kade (u primeru dodatne kratke obloge)	3838987 590750	29,00
	Suhomontažna zaključna letva Završna letva u sistemu suhe montaže	karton 25 kosov / karton 25 komada (Cena za kos / Cijena na komad 32,00 EUR)	3838987 903116	800,00
	Chromoterapia (CTL) Chromoterapia (CTL)	2 LED lučki s samostojno tipkovnico 2 LED svjetla sa samostalnom tipkovnicom		401,00
	Servisno prezračevalni pokrov z rešetko Servisno ventilacijski pokrov s rešetkom	za masažne kadi za vgradnjo (45x45 cm) za masažne kade za ugradnju (45x45 cm)	3838987 534808	95,00
	ANTI-SLIP PREMAZ	protizdrsni premaz za kopalne kadi protiv klizni premaz za kupaonske kade (min. kol. 10 kos)		70,00
	Specialno čistilo KOLPA SAN Specialno sredstvo za čišćenje	karton 20 kosov / karton 20 komada (Cena za kos / Cijena na komad 6,50 EUR)	3838987 747291	130,00
	Specialno čistilo ECO SAN Specialno sredstvo za čišćenje	karton 20 kosov / karton 20 komada (Cena za kos / Cijena na komad 5,70 EUR)	3838987 572220	114,00
	Čistilo za masažne sisteme Sredstvo za čišćenje masažnih sistema	karton 10 kosov / karton 10 komada (Cena za kos / Cijena na komad 8,20 EUR)	3838987 747277	82,00















Kopalne in masažne kadi

Kade za kupanje i masažne kade

Program:













kolpa·san
BY KOLPA

Model	Naziv in dimenzija izdelka Naziv i dimenzije produkta	Opis Opis	EAN koda EAN koda	Cena EUR Cijena EUR
Evelin bathtub 170x75				
	Evelin bathtub 170x75 KOS/KOMAD na paleti = 15	kopalna kad za vgradnjo kada za ugradnju	3838987 593072	175,00
	Obloga s podnožjem Evelin / Tamia 170x75	kratka in dolga obloga s podnožjem kratka i duga obloga sa podnožjem	3838987 571285	217,00
	Vodni masažni sistem I. Vodeni masažni sistem I. PNEVMATSKI Evelin bathtub 170x75	z oblogo / s oblogom	3838987 576488	978,00
Dodatki za / Dodaci za Evelin bathtub 170x75				
	UP&DOWN, WHITE	prelivna garnitura s sifonom, bela preljevna garnitura sa sifonom, bijela	3838987 922759	65,00
	PAL 650, CHR	prelivna garnitura s sifonom, krom preljevna garnitura sa sifonom, krom	3838987 746270	58,00
	HEADREST COAST	vzglavnik naslon za glavu	3838987 593928	108,00
	SKK	sedež za kopalno kad sjedalo za kupaonsku kadu	3838987 950943	106,00
	PKK 501	podnožje kopalne kadi za vgradnjo podnožje kupaonske kade za ugradnju	3838987 764878	29,00
	Zidni montažni set Zidni montažni set	za kopalne in tuš kadi za vgradnjo za kupaonske i tuš kade za ugradnju	3838987 704362	12,00
	Montažni set za oblogo Montažni set za oblogu	za kopalno kad Tamia (v primeru dodatne kratke obloge) / za kupaonsku kadu Tamia (u primeru dodatne kratke obloge)	3838987 994787	29,00
	Suhomontažna zaključna letva Završna letva u sistemu suhe montaže	karton 25 kosov / karton 25 komada (Cena za kos / Cijena na komad 32,00 EUR)	3838987 903116	800,00
	Servisno prezračevalni pokrov z rešetko Servisno ventilacijski pokrov s rešetkom	za masažne kadi za vgradnjo (45x45 cm) za masažne kade za ugradnju (45x45 cm)	3838987 534808	95,00
	ANTI-SLIP PREMAZ	protizdrsni premaz za kopalne kadi protiv klizni premaz za kupaonske kade (min. kol. 10 kos)		70,00
	Specialno čištilo KOLPA SAN Specialno sredstvo za čiščenje	karton 20 kosov / karton 20 komada (Cena za kos / Cijena na komad 6,50 EUR)	3838987 747291	130,00
	Specialno čištilo ECO SAN Specialno sredstvo za čiščenje	karton 20 kosov / karton 20 komada (Cena za kos / Cijena na komad 5,70 EUR)	3838987 572220	114,00
	Čistilo za masažne sisteme Sredstvo za čiščenje masažnih sistema	karton 10 kosov / karton 10 komada (Cena za kos / Cijena na komad 8,20 EUR)	3838987 747277	82,00

Kopalne in masažne kadi

Kade za kupanje i masažne kade

Program:**kolpa·san**
BY KOLPA





Model	Naziv in dimenzija izdelka Naziv i dimenzije produkta	Opis Opis	EAN koda EAN koda	Cena EUR Cijena EUR
Evelin bathtub 170x70, 160x70, 150x70, 140x70				
	Evelin bathtub 170x70 Evelin bathtub 160x70 Evelin bathtub 150x70 Evelin bathtub 140x70	kopalna kad za vgradnjo kada za ugradnju	3838987 593348 3838987 593355 3838987 593362 3838987 593379	175,00 175,00 175,00 167,00
	<small>KOS/KOMAD na paleti = 15</small>			
	Obloga s podnožjem Evelin / Tamia 170x70 Obloga s podnožjem Evelin / Tamia 160x70 Obloga s podnožjem Evelin / Tamia 150x70 Obloga s podnožjem Evelin / Tamia 140x70	kratka in dolga obloga s podnožjem kratka i duga obloga sa podnožjem	3838987 571278 3838987 571261 3838987 572985 3838987 572978	217,00 217,00 217,00 217,00
Dodatki za / Dodaci za Evelin bathtub				
	UP&DOWN, WHITE	prelivna garnitura s sifonom, bela prelivna garnitura sa sifonom, bijela	3838987 922759	65,00
	PAL 650, CHR	prelivna garnitura s sifonom, krom prelivna garnitura sa sifonom, krom	3838987 746270	58,00
	HEADREST COAST	vzglavnik naslon za glavu	3838987 593928	108,00
	SKK	sedež za kopalno kad sjedalo za kupaonsku kadu	3838987 950943	106,00
	PKK 501	podnožje kopalne kadi za vgradnjo podnožje kupaonske kade za ugradnju	3838987 764878	29,00
	Zidni montažni set Zidni montažni set	za kopalne in tuš kadi za vgradnjo za kupaonske i tuš kade za ugradnju	3838987 704362	12,00
	Montažni set za oblogo Montažni set za oblogo	za kopalno kad Tamia (v primeru dodatne kratke obloge) / za kupaonsku kadu Tamia (u primeru dodatne kratke obloge)	3838987 994787	29,00
	Suhomontažna zaključna letva Završna letva u sistemu suhe montaže	karton 25 kosov / karton 25 komada (Cena za kos / Cijena na komad 32,00 EUR)	3838987 903116	800,00
	Servisno prezračevalni pokrov z rešetko Servisno ventilacijski pokrov s rešetkom	za masažne kadi za vgradnjo (45x45 cm) za masažne kade za ugradnju (45x45 cm)	3838987 534808	95,00
	ANTI-SLIP PREMAZ	protizdrsni premaz za kopalne kadi protiv klizni premaz za kupaonske kade (min. kol. 10 kos)		70,00
	Specialno čistilo KOLPA SAN Specialno sredstvo za čiščenje Specialno čistilo ECO SAN Specialno sredstvo za čiščenje	karton 20 kosov / karton 20 komada (Cena za kos / Cijena na komad 6,50 EUR) karton 20 kosov / karton 20 komada (Cena za kos / Cijena na komad 5,70 EUR)	3838987 747291 3838987 572220	130,00 114,00



Kopalne in masažne kadi
Kade za kupanje i masažne kade

Program:







kolpa·san
BY KOLPA

Model	Naziv in dimenzija izdelka Naziv i dimenzije produkta	Opis Opis	EAN koda EAN koda	Cena EUR Cijena EUR
Tamia 180x80				
	Tamia 180x80 KOS/KOMAD na paleti = 15	kopalna kad za vgradnjo kada za ugradnju	3838987 539643	229,00
	Obloga s podnožjem Tamia 180x80	kratka in dolga obloga s podnožjem kratka i duga obloga sa podnožjem	3838987 571292	250,00
	Vodni masažni sistem I. Vodeni masažni sistem I. PNEVMATSKI Tamia 180x80	z oblogo / s oblogom	3838987 927556	1.202,00
Dodatki za / Dodaci za Tamia 180x80				
	UP&DOWN, WHITE	prelivna garnitura s sifonom, bela preljevna garnitura sa sifonom, bijela	3838987 922759	65,00
	PAL 450, CHR	prelivna garnitura s sifonom, krom preljevna garnitura sa sifonom, krom	3838987 746263	42,00
	HEADREST SOFT HEADREST COAST	vzglavnik naslon za glavu	3838987 593942 3838987 593928	83,00 108,00
	PKK 501	podnožje kopalne kadi za vgradnjo podnožje kupaonske kade za ugradnju	3838987 764878	29,00
	Zidni montažni set Zidni montažni set	za kopalne in tuš kadi za vgradnjo za kupaonske i tuš kade za ugradnju	3838987 704362	12,00
	Montažni set za oblogo Montažni set za oblogo	za kopalno kad Tamia (v primeru dodatne kratke obloge) / za kupaonsku kadu Tamia (u primeru dodatne kratke obloge)	3838987 994787	29,00
	Suhomontažna zaključna letva Završna letva u sistemu suhe montaže	karton 25 kosov / karton 25 komada (Cena za kos / Cijena na komad 32,00 EUR)	3838987 903116	800,00
	Servisno prezračevalni pokrov z rešetko Servisno ventilacijski pokrov s rešetkom	za masažne kadi za vgradnjo (45x45 cm) za masažne kade za ugradnju (45x45 cm)	3838987 534808	95,00
	ANTI-SLIP PREMAZ	protizdrsni premaz za kopalne kadi protiv klizni premaz za kupaonske kade (min. kol. 10 kos)		70,00
	Specialno čištilo KOLPA SAN Specialno sredstvo za čiščenje Specialno čištilo ECO SAN Specialno sredstvo za čiščenje Čištilo za masažne sisteme Sredstvo za čiščenje masažnih sistema	karton 20 kosov / karton 20 komada (Cena za kos / Cijena na komad 6,50 EUR) karton 20 kosov / karton 20 komada (Cena za kos / Cijena na komad 5,70 EUR) karton 10 kosov / karton 10 komada (Cena za kos / Cijena na komad 8,20 EUR)	3838987 747291 3838987 572220 3838987 747277	130,00 114,00 82,00

Kopalne in masažne kadi
Kade za kupanje i masažne kade

Program:

kolpa·san
BY KOLPA















Model	Naziv in dimenzija izdelka Naziv i dimenzije produkta	Opis Opis	EAN koda EAN koda	Cena EUR Cijena EUR
Tamia 170x75				
	Tamia 170x75 KOS/KOMAD na paleti = 15	kopalna kad za vgradnjo kada za ugradnju	3838987 749981	177,00
	Obloga s podnožjem Evelin / Tamia 170x75	kratka in dolga obloga s podnožjem kratka i duga obloga sa podnožjem	3838987 571285	217,00
	Vodni masažni sistem I. Vodeni masažni sistem I. PNEVMATSKI Tamia 170x75	z oblogo / s oblogom	3838987 590644	981,00
Dodatki za / Dodaci za Tamia 170x75				
	UP&DOWN, WHITE	prelivna garnitura s sifonom, bela preljevna garnitura sa sifonom, bijela	3838987 922759	65,00
	PAL 450, CHR	prelivna garnitura s sifonom, krom preljevna garnitura sa sifonom, krom	3838987 746263	42,00
	HEADREST SOFT	vzglavnik naslon za glavu	3838987 593942	83,00
	HEADREST COAST		3838987 593928	108,00
	SKK	sedež za kopalno kad sjedalo za kupaonsku kadu	3838987 950943	106,00
	PKK 501	podnožje kopalne kadi za vgradnjo podnožje kupaonske kade za ugradnju	3838987 764878	29,00
	Zidni montažni set Zidni montažni set	za kopalne in tuš kadi za vgradnjo za kupaonske i tuš kade za ugradnju	3838987 704362	12,00
	Montažni set za oblogo Montažni set za oblogu	za kopalno kad Tamia (v primeru dodatne kratke obloge) / za kupaonsku kadu Tamia (u primeru dodatne kratke obloge)	3838987 994787	29,00
	Suhomontažna zaključna letva Završna letva u sistemu suhe montaže	karton 25 kosov / karton 25 komada (Cena za kos / Cijena na komad 32,00 EUR)	3838987 903116	800,00
	Servisno prezračevalni pokrov z rešetko Servisno ventilacijski pokrov s rešetkom	za masažne kadi za vgradnjo (45x45 cm) za masažne kade za ugradnju (45x45 cm)	3838987 534808	95,00
	ANTI-SLIP PREMAZ	protizdrsni premaz za kopalne kadi protiv klizni premaz za kupaonske kade (min. kol. 10 kos)		70,00
	Specialno čištilo KOLPA SAN Specialno sredstvo za čiščenje	karton 20 kosov / karton 20 komada (Cena za kos / Cijena na komad 6,50 EUR)	3838987 747291	130,00
	Specialno čištilo ECO SAN Specialno sredstvo za čiščenje	karton 20 kosov / karton 20 komada (Cena za kos / Cijena na komad 5,70 EUR)	3838987 572220	114,00
	Čistilo za masažne sisteme Sredstvo za čiščenje masažnih sistema	karton 10 kosov / karton 10 komada (Cena za kos / Cijena na komad 8,20 EUR)	3838987 747277	82,00



Kopalne in masažne kadi
Kade za kupanje i masažne kade

Program:

kolpa·san
BY KOLPA

















Model	Naziv in dimenzija izdelka Naziv i dimenzije produkta	Opis Opis	EAN koda EAN koda	Cena EUR Cijena EUR
Tamia 170x70, 160x70, 150x70				
	<p>Tamia 170x70</p> <p>Tamia 160x70</p> <p>Tamia 150x70</p> <p>KOS/KOMAD na paleti = 15</p>	<p>kopalna kad za vgradnjo kada za ugradnju</p>	<p>3838987 992233</p> <p>3838987 752905</p> <p>3838987 755319</p>	<p>177,00</p> <p>177,00</p> <p>177,00</p>
	<p>Obloga s podnožjem Evelin / Tamia 170x70</p> <p>Obloga s podnožjem Evelin / Tamia 160x70</p> <p>Obloga s podnožjem Tamia 150x70</p>	<p>kratka in dolga obloga s podnožjem kratka i duga obloga sa podnožjem</p>	<p>3838987 571278</p> <p>3838987 571261</p> <p>3838987 572985</p>	<p>217,00</p> <p>217,00</p> <p>217,00</p>
Dodatki za / Dodaci za Tamia				
	UP&DOWN, WHITE	prelivna garnitura s sifonom, bela preljevna garnitura sa sifonom, bijela	3838987 922759	65,00
	PAL 450, CHR	prelivna garnitura s sifonom, krom preljevna garnitura sa sifonom, krom	3838987 746263	42,00
	HEADREST SOFT	vzglavnik naslon za glavu	3838987 593942	83,00
	HEADREST COAST	vzglavnik naslon za glavu	3838987 593928	108,00
	SKK	sedež za kopalno kad sjedalo za kupaonsku kadu	3838987 950943	106,00
	PKK 501	podnožje kopalne kadi za vgradnjo podnožje kupaonske kade za ugradnju	3838987 764878	29,00
	Zidni montažni set Zidni montažni set	za kopalne in tuš kadi za vgradnjo za kupaonske i tuš kade za ugradnju	3838987 704362	12,00
	Montažni set za oblogu Montažni set za oblogu	za kopalno kad Tamia (v primeru dodatne kratke obloge) / za kupaonsku kadu Tamia (u primeru dodatne kratke obloge)	3838987 994787	29,00
	Suhomontažna zaključna letva Završna letva u sistemu suhe montaže	karton 25 kosov / karton 25 komada (Cena za kos / Cijena na komad 32,00 EUR)	3838987 903116	800,00
	Servisno prezračevalni pokrov z rešetko Servisno ventilacijski pokrov s rešetkom	za kopalne kadi za vgradnjo (45x45 cm) za kupaonske kade za ugradnju (45x45 cm)	3838987 534808	95,00
	ANTI-SLIP PREMAZ	protizdrsni premaz za kopalne kadi protiv klizni premaz za kupaonske kade (min. kol. 10 kos)		70,00
	Specialno čistilo KOLPA SAN Specialno sredstvo za čiščenje	karton 20 kosov / karton 20 komada (Cena za kos / Cijena na komad 6,50 EUR)	3838987 747291	130,00
	Specialno čistilo ECO SAN Specialno sredstvo za čiščenje	karton 20 kosov / karton 20 komada (Cena za kos / Cijena na komad 5,70 EUR)	3838987 572220	114,00
114	www.kolpasan.si	www.kolpasan.hr		

Kopalne in masažne kadi













Kade za kupanje i masažne kade

Program:

kolpa·san
BY KOLPA

Model	Naziv in dimenzija izdelka Naziv i dimenzije produkta	Opis Opis	EAN koda EAN koda	Cena EUR Cijena EUR
Tamia 140x70, 140x70/S				
	Tamia 140x70 KOS/KOMAD na paleti = 15	kopalna kad za vgradnjo kada za ugradnju	3838987 752912	170,00
	Tamia 140x70/S	kopalna kad za vgradnjo s sedežem kada za ugradnju sa sjedalom	3838987 752943	170,00
	Obloga s podnožjem Tamia 140x70 in Tamia 140x70/S	kratka in dolga obloga s podnožjem kratka i duga obloga sa podnožjem	3838987 572978	217,00
Dodatki za / Dodaci za Tamia 140x70				
	UP&DOWN, WHITE	prelivna garnitura s sifonom, bela preljevna garnitura sa sifonom, bijela	3838987 922759	65,00
	PAL 450, CHR	prelivna garnitura s sifonom, krom preljevna garnitura sa sifonom, krom	3838987 746263	42,00
	HEADREST SOFT	vzglavnik naslon za glavu	3838987 593942	83,00
	HEADREST HEADREST COAST	vzglavnik naslon za glavu	3838987 593928	108,00
	SKK	sedež za kopalno kad sjedalo za kupaonsku kadu	3838987 950943	106,00
	PKK 501	podnožje kopalne kadi za vgradnjo podnožje kupaonske kade za ugradnju	3838987 764878	29,00
	Zidni montažni set Zidni montažni set	za kopalne in tuš kadi za vgradnjo za kupaonske i tuš kade za ugradnju	3838987 704362	12,00
	Montažni set za oblogo Montažni set za oblogu	za kopalno kad Tamia (v primeru dodatne kratke obloge) / za kupaonsku kadu Tamia (u primeru dodatne kratke obloge)	3838987 994787	29,00
	Suhomontažna zaključna letva Završna letva u sistemu suhe montaže	karton 25 kosov / karton 25 komada (Cena za kos / Cijena na komad 32,00 EUR)	3838987 903116	800,00
	Servisno prezračevalni pokrov z rešetkom Servisno ventilacijski pokrov s rešetkom	za kopalne kadi za vgradnjo (45x45 cm) za kupaonske kade za ugradnju (45x45 cm)	3838987 534808	95,00
	ANTI-SLIP PREMAZ	protizdrsni premaz za kopalne kadi protiv klizni premaz za kupaonske kade (min. kol. 10 kos)		70,00
	Specialno čistilo KOLPA SAN Specialno sredstvo za čiščenje	karton 20 kosov / karton 20 komada (Cena za kos / Cijena na komad 6,50 EUR)	3838987 747291	130,00
	Specialno čistilo ECO SAN Specialno sredstvo za čiščenje	karton 20 kosov / karton 20 komada (Cena za kos / Cijena na komad 5,70 EUR)	3838987 572220	114,00
www.kolpasan.hr		www.kolpasan.si		115













Kopalne in masažne kadi Kade za kupanje i masažne kade		Program: kolpa·san®		
Model	Naziv in dimenzija izdelka Naziv i dimenzije produkta	Opis Opis	EAN koda EAN koda	Cena EUR Cijena EUR
Figaro 170x75, 160x80, 150x70				
	Figaro 170x75	kopalna kad za vgradnjo kada za ugradnju	3838987 741435	312,00
	Figaro 160x80	kopalna kad za vgradnjo kada za ugradnju	3838987 596097	312,00
	Figaro 150x70	kopalna kad za vgradnjo kada za ugradnju	3838987 757634	285,00
Dodatki za / Dodaci za Figaro 170x75				
	UP&DOWN, WHITE	prelivna garnitura s sifonom, bela prelivna garnitura sa sifonom, bijela	3838987 922759	65,00
	PAL 450, CHR	prelivna garnitura s sifonom, krom prelivna garnitura sa sifonom, krom	3838987 746263	42,00
	HEADREST COAST	vzglavnik naslon za glavu	3838987 593928	108,00
	SKK	sedež za kopalno kad sjedalo za kupaonsku kadu	3838987 950943	106,00
	PKK 501	podnožje kopalne kadi za vgradnjo podnožje kupaonske kade za ugradnju	3838987 764878	29,00
	Zidni montažni set Zidni montažni set	za kopalne in tuš kadi za vgradnjo za kupaonske i tuš kade za ugradnju	3838987 704362	12,00
	Suhomontažna zaključna letev Završna letva u sistemu suhe montaže	karton 25 kosov / karton 25 komada (Cena za kos / Cijena na komad 32,00 EUR)	3838987 903116	800,00
	Servisno prezračevalni pokrov z rešetko Servisno ventilacijski pokrov s rešetkom	za kopalne kadi za vgradnjo (45x45 cm) za kupaonske kade za ugradnju (45x45 cm)	3838987 534808	95,00
	ANTI-SLIP PREMAZ	protizdrnsni premaz za kopalne kadi protiv klizni premaz za kupaonske kade (min. kol. 10 kos)		70,00
	Specialno čistilo KOLPA SAN Specialno sredstvo za čišćenje	karton 20 kosov / karton 20 komada (Cena za kos / Cijena na komad 6,50 EUR)	3838987 747291	130,00
	Specialno čistilo ECO SAN Specialno sredstvo za čišćenje	karton 20 kosov / karton 20 komada (Cena za kos / Cijena na komad 5,70 EUR)	3838987 572220	114,00

Kopalne in masažne kadi

Kade za kupanje i masažne kade

Program:**kolpa·san**
by KOLPA



Model	Naziv in dimenzija izdelka Naziv i dimenzije produkta	Opis Opis	EAN koda EAN koda	Cena EUR Cijena EUR
Mini 100x70				
	Mini 100x70	kopalna kad za vgradnjo kada za ugradnju	3838987 945543	214,00
Dodatki za / Dodaci za Mini 100x70				
	UP&DOWN, WHITE	prelivna garnitura s sifonom, bela preljevna garnitura sa sifonom, bijela	3838987 922759	65,00
	PAL 450, CHR	prelivna garnitura s sifonom, krom preljevna garnitura sa sifonom, krom	3838987 746263	42,00
	HEADREST COAST	vzglavnik naslon za glavu	3838987 593928	108,00
	SKK	sedež za kopalno kad sjedalo za kupaonsku kadu	3838987 950943	106,00
	PKK 501	podnožje kopalne kadi za vgradnjo podnožje kupaonske kade za ugradnju	3838987 764878	29,00
	Zidni montažni set Zidni montažni set	za kopalne in tuš kadi za vgradnjo za kupaonske i tuš kade za ugradnju	3838987 704362	12,00
	Suhomontažna zaključna letev Završna letva u sistemu suhe montaže	karton 25 kosov / karton 25 komada (Cena za kos / Cijena na komad 32,00 EUR)	3838987 903116	800,00
	Servisno prezračevalni pokrov z rešetko Servisno ventilacijski pokrov s rešetkom	za kopalne kadi za vgradnjo (45x45 cm) za kupaonske kade za ugradnju (45x45 cm)	3838987 534808	95,00
	ANTI-SLIP PREMAZ	protizdrsni premaz za kopalne kadi protiv klizni premaz za kupaonske kade (min. kol. 10 kos)		70,00
	Specialno čistilo KOLPA SAN Specialno sredstvo za čiščenje	karton 20 kosov / karton 20 komada (Cena za kos / Cijena na komad 6,50 EUR)	3838987 747291	130,00
	Specialno čistilo ECO SAN Specialno sredstvo za čiščenje	karton 20 kosov / karton 20 komada (Cena za kos / Cijena na komad 5,70 EUR)	3838987 572220	114,00



Armature za kopalne kadi

Armature za kupaonske kade

Program:**kolpa·san**
BY KOLPA

Model	Naziv in dimenzija izdelka Naziv i dimenzije produkta	Opis Opis	EAN koda EAN koda	Cena EUR Cijena EUR
WATERFALL				
	WATERFALL	enoročna armatura s tuš ročico in izlivom / jednoručna armatura s tuš ručicom i izljevom za kadi z oblogo / za kade s oblogom, pri kadeh brez obloge je obvezna ustrezno velika servisna odprtina kod kada bez obloge obavezni je dovoljno velik servisni otvor	3838987 734543	590,00
GEYSER				
	GEYSER	enoročna arm. s tuš ročico in polnilno /odlivno prelivno gar. za polnjenje kadi jednoručna arm. s tuš ručicom i priljev/odljev prelivnom garniturom za punjenje kada za kadi z oblogo / za kade s oblogom, pri kadeh brez obloge je obvezna ustrezno velika servisna odprtina kod kada bez obloge obavezni je dovoljno velik servisni otvor	3838987 506287	633,00
RAINDROP				
	RAINDROP	enoročna armatura s tuš ročico in izlivom / jednoručna armatura s tuš ručicom i izljevom za kadi z oblogo / za kade s oblogom, pri kadeh brez obloge je obvezna ustrezno velika servisna odprtina kod kada bez obloge obavezni je dovoljno velik servisni otvor	3838987 726500	620,00

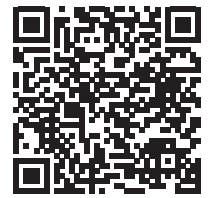

Masažne kabine, parne savne in masažni stebri

Masažne kabine, parne saune i masažni stupovi

Slike so simbolične. Pravilna razporeditev elementov je v TEHNIČNEM KATALOGU na www.kolpasan.si
Slike su simbolične. Točan raspored elemenata je u TEHNIČKOM KATALOGU na www.kolpasan.hr

2





leti garancije
godine jamstva











Masažne kabine, stebri

Masažne kabine, stupovi

Program:**kolpa·san**
BY KOLPA

Model	Naziv in dimenzija izdelka Naziv i dimenzije produkta	Opis Opis	EAN koda EAN koda	Cena EUR Cijena EUR
Melba 100				
	Melba M3 100x100	masažna kabina s parno savno (kaljeno prozorno steklo) masažna kabina s parnom saunom (kaljeno prozirno staklo)	3838987 932581	2.940,00
	Melba M1 100x100	parna savna - s stropno prho in ročnim tušem (kaljeno prozorno steklo) parna sauna - stropni tuš i tuš ručka (kaljeno prozirno staklo)	3838987 593904	2.661,00
	Melba SIMPLE 100x100	tuš kabina - s stropno prho in ročnim tušem (kaljeno prozorno steklo) tuš kabina - stropni tuš i tuš ručka (kaljeno prozirno staklo)	3838987 593898	1.965,00
Aria QUAT				
	Aria QUAT A3 90x90	masažna kabina s parno savno (kaljeno prozorno steklo) masažna kabina s parnom saunom (kaljeno prozirno staklo)	3838987 731832	2.727,00
	Aria QUAT A0 90x90	masažna kabina (kaljeno prozorno steklo) masažna kabina (kaljeno prozirno staklo)	3838987 799047	1.708,00
	Aria QUAT SIMPLE 90x90	tuš kabina - s stropno prho in ročnim tušem (kaljeno prozorno steklo) tuš kabina - stropni tuš i tuš ručka (kaljeno prozirno staklo)	3838987 500032	1.708,00
Sky 1600 3f				
	Sky 1600 3f - white 109	prilagodljiv masažni steber za tuš kabino, Kerrock (za tuš kadi širine 80-90 cm) fleksibilni masažni stup za tuš kabino, od Kerrocka (za tuš kade širine 80-90 cm)	3838987 593010	1.267,00
	Sky 1600 3f - andesite 9252		3838987 927686	1.267,00
	WO Sky 120 - UNI SBR/1 Calypso	tuš stena, silver brill – 8 mm steklo tuš stijenka, silver brill	3838987 518327	321,00
	WO Sky 140 - UNI SBR/1 Calypso		3838987 518341	357,00
	WO Sky 120 - UNI B/1 Calypso	tuš stena, črni profil – 8 mm steklo tuš stijenka, crni profil	3838987 518310	337,00
	WO Sky 140 - UNI B/1 Calypso		3838987 518334	373,00
Dodatki / Dodaci				
	Specialno čistilo KOLPA SAN Specialno sredstvo za čiščenje	krt = 20 x 0,5 l (Cena za kos / Cijena na komad 6,50 EUR)	3838987 747291	130,00
	Specialno čistilo ECO SAN Specialno sredstvo	krt = 20 x 0,5 l (Cena za kos / Cijena na komad 5,70 EUR)	3838987 572220	114,00
	KERIL - Specialno čistilo za KERROCK KERIL - Specialno sredstvo	krt = 12 x 0,5 l (Cena za kos / Cijena na komad 4,50 EUR)	3838987 747307	54,00

Masažni stebri Masažni stupovi		Program: kolpa·san®		
Model	Naziv in dimenzija izdelka Naziv i dimenzije produkta	Opis Opis	EAN koda EAN koda	Cena EUR Cijena EUR
Solano 1400 2f				
Kerrock barva / Boja				
	Solano 1400 2f - white 109	steber za tuš kabino, stenska izvedba, Kerrock stup za tuš kabinu, stijenska izvedba, Kerrock	3838987 564096	1.118,00
	Solano 1400 2f - andesite 9252		3838987 564072	1.118,00
Slim 1600 2f				
Kerrock barva / Boja				
	Slim 1600 2f - white 109	steber za tuš kabino, stenska izvedba, Kerrock stup za tuš kabinu, stijenska izvedba, Kerrock	3838987 564089	977,00
	Slim 1600 2f - andesite 9252		3838987 564065	977,00
Zonda FLAT 1600 3f				
Kerrock barva / Boja				
	Zonda FLAT 1600 3f - white 109	masažni steber za tuš kabino, stenska izvedba, Kerrock masažni stup za tuš kabinu, stijenska izvedba, Kerrock	3838987 572893	1.009,00
	Zonda FLAT 1600 3f - andesite 9252		3838987 927693	1.009,00
Zonda 1500 4f				
Kerrock barva / Boja				
	Zonda 1500 4f - white 109	masažni steber za tuš kabino, stenska izvedba, Kerrock masažni stup za tuš kabinu, stijenska izvedba, Kerrock	3838987 593607	1.219,00
	Zonda 1500 4f - andesite 9252		3838987 927679	1.219,00
Dodatki / Dodaci				
	Specialno čistilo KOLPA SAN Specialno sredstvo za čišćenje	krt = 20 x 0,5 l (Cena za kos / Cijena na komad 6,50 EUR)	3838987 747291	130,00
	Specialno čistilo ECO SAN Specialno sredstvo	krt = 20 x 0,5 l (Cena za kos / Cijena na komad 5,70 EUR)	3838987 572220	114,00
	KERIL - Specialno čistilo za KERROCK KERIL - Specialno sredstvo	krt = 12 x 0,5 l (Cena za kos / Cijena na komad 4,50 EUR)	3838987 747307	54,00
www.kolpasan.hr		www.kolpasan.si		121

Masažni stebri Masažni stupovi		Program: kolpa·san [®]		
Model	Naziv in dimenzija izdelka Naziv i dimenzije produkta	Opis Opis	EAN koda EAN koda	Cena EUR Cijena EUR
Zonda 1500 3f		Kerrock barva / Boja		
	Zonda 1500 3f - white 109	masažni steber za tuš kabino, stenska izvedba, Kerrock masažni stup za tuš kabinu, stijenska izvedba, Kerrock	3838987 570967	972,00
	Zonda 1500 3f - andesite 9252		3838987 927662	972,00
Zephyr 1680 3f		Kerrock barva / Boja		
	Zephyr 1680 3f - white 109	masažni steber za tuš kabino, stenska izvedba, Kerrock masažni stup za tuš kabinu, stijenska izvedba, Kerrock	3838987 962571	1.068,00
	Zephyr 1680 3f - andesite 9252		3838987 927709	1.068,00
Dodatki / Dodaci				
	Specialno čistilo KOLPA SAN Specialno sredstvo za čiščenje	krt = 20 x 0,5 l (Cena za kos / Cijena na komad 6,50 EUR)	3838987 747291	130,00
	Specialno čistilo ECO SAN Specijalno sredstvo	krt = 20 x 0,5 l (Cena za kos / Cijena na komad 5,70 EUR)	3838987 572220	114,00
	KERIL - Specialno čistilo za KERROCK KERIL - Specijalno sredstvo	krt = 12 x 0,5 l (Cena za kos / Cijena na komad 4,50 EUR)	3838987 747307	54,00



Tuš kadi Tuš kade

Acro 140, 120, 100	131	Limbo 140, 120	129
Ballo 200, 140	124	Macarena 100, 90	133
Ballo 200, 140	124	Malur 120, 100 -L	138
Canary 140, 120, 100, 90, 80	132	Malur 120, 100 -D	138
Capo 140, 120, 100, 90	131	Moonwalk 140, 120, 100, 90	127
Dixie 90	139	Moonwalk 140, 120, 100, 90	128
Drop 140, 120, 100, 90, 80	134	Moonwalk R 100, 90	132
Drop R 90, 80	138	Ontex 90, 80	140
Evelin tray Q 120	137	Pandora tray 120, 100, 90	131
Evelin tray Q 90, 80	137	Ramona tray 120	126
Evelin tray R 90, 80	140	Re-Walk 180, 140	129
Flamenco 110, 100, 90, 80, 70	136	Re-Walk 180, 140	129
Flamenco 180, 170, 160, 140, 130, 120	135	Serra 140, 120, 90	133
Funky 120, 100	136	Stiletto 130	129
Lavolta 160, 140, 120, 100, 90	125	Tello 160, 140, 120, 100, 90	124
Lavolta R 100, 90	126	Tello 160, 140, 120, 100, 90	124
Lerock ZERO 120, 100, 90	126	Tobas 140, 120, 100, 90	130
Limbo 140, 120	128	Trin 90, 80	137

7

let garancije
godina jamstva

Izdelki iz modificiranega akrila
Proizvod od modificiranog akrila

10

let garancije
godina jamstva

Izdelki iz Kerrocka, litega marmorja in litega sanitarnega akrila
Proizvod od Kerrocka, lijevanog mramora i od lijevanog sanitarnog akrila



Prerez tuš kadi po meri

Prilagođeno obrezivanje tuš kade



Tehnički listi prerezovanja: Ballo 141, Tello 142/143, Moonwalk 144, Limbo 145, Re-Walk 146

Tehnički list obrezivanja na stranici; Ballo 141, Tello 142/143, Moonwalk 144, Limbo 145, Re-Walk 146







Tuš kadi za
obrezovanje
Tuš kade za
obrezivanje

Slike so simbolične. Pravilna rasporeditev elementov je v TEHNIČNEM KATALOGU na www.kolpasan.si
Slike su simbolične. Točan raspored elemenata je u TEHNIČKOM KATALOGU na www.kolpasan.hr

Tuš kadi
Tuš kade

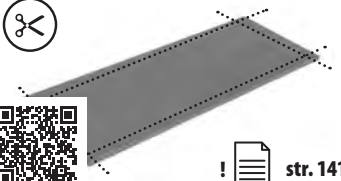

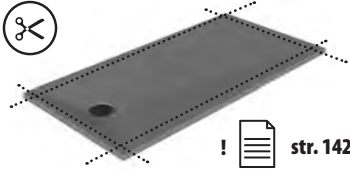
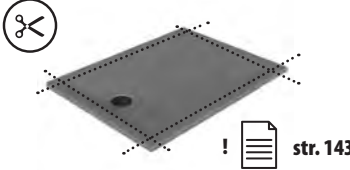
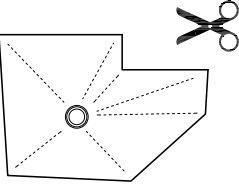

Program: Kerrock

kolpa·san
BY KOLPA





Model	Naziv in dimenzija izdelka Naziv i dimenzije produkta	Opis Opis	EAN koda EAN koda	Cena EUR Cijena EUR	
Ballo 200, 140					
		Barva / Boja			
	Ballo 200x90	- white 108	tuš kad za vgradnjo ali postavitve na tla iz Kerrocka	3838987 551119	1.002,00
	Ballo 200x80	- white 108	ugradbena kada za tuširanje ili instalacija na pod, od Kerrocka	3838987 551102	910,00
	Ballo 140x90	- white 108		3838987 551096	727,00
	Ballo 140x80	- white 108		3838987 551089	664,00
 ! str. 141	Ballo 200x90	- white 108	tuš kad za vgradnjo ali postavitve na tla iz Kerrocka	3838987 518228	1.153,00
	Ballo 200x80	- white 108	- prerez po meri	3838987 518211	1.047,00
	Ballo 140x90	- white 108	ugradbena kada za tuširanje ili instalacija na pod, od Kerrocka	3838987 518204	836,00
	Ballo 140x80	- white 108	- prilagođeno obrezivanje	3838987 518198	764,00
	Sifon Ø 90 brez pokrova H=65 mm		Sifon Ø 90 za tuš kadi, H=65 mm	3838987 563181	19,00
	Sifon Ø 90 brez pokrova H=84 mm		Sifon Ø 90 za tuš kade, H=65 mm		
	Sifon Ø 90 brez pokrova H=84 mm		Sifon Ø 90 za tuš kadi, H=84 mm	3838987 927723	16,00
	Sifon Ø 90 za tuš kade, H=84 mm				
Tello 160, 140, 120, 100, 90					
	Tello 160x90	- white 108	tuš kad za vgradnjo ali postavitve na tla iz Kerrocka / ugradbena kada za tuširanje ili instalacija na pod, od Kerrocka	3838987 551072	813,00
	Tello 160x80	- white 108		3838987 551041	742,00
	Tello 140x90	- white 108	Priložen / priložen	3838987 551065	734,00
	Tello 140x80	- white 108	Sifon Ø 90 s kerrock pokrovom H=60 mm	3838987 551034	675,00
		Sifon Ø 90 s poklopcem od kerrocka H=60 mm			
	Tello 120x90	- white 108	tuš kad za vgradnjo ali postavitve na tla iz Kerrocka / ugradbena kada za tuširanje ili instalacija na pod, od Kerrocka	3838987 551058	658,00
	Tello 120x80	- white 108		3838987 551027	605,00
	Tello 100x80	- white 108	Priložen / priložen	3838987 551010	545,00
	Tello 90x90	- white 108	Sifon Ø 90 s kerrock pokrovom H=60 mm	3838987 551003	545,00
		Sifon Ø 90 s poklopcem od kerrocka H=60 mm			
 ! str. 142	Tello 160x90	- white 108	tuš kad za vgradnjo ali postavitve na tla iz Kerrocka / ugradbena kada za tuširanje ili instalacija na pod, od Kerrocka	3838987 518303	933,00
	Tello 160x80	- white 108		3838987 518273	854,00
	Tello 140x90	- white 108	- prerez po meri / - prilagođeno obrezivanje	3838987 518297	844,00
	Tello 140x80	- white 108		3838987 518266	776,00
 ! str. 143	Tello 120x90	- white 108	Priložen / priložen	3838987 518280	757,00
	Tello 120x80	- white 108	Sifon Ø 90 s kerrock pokrovom H=60 mm	3838987 518259	695,00
	Tello 100x80	- white 108	Sifon Ø 90 s poklopcem od kerrocka H=60 mm.	3838987 518242	627,00
	Tello 90x90	- white 108		3838987 518235	627,00
 ! str. 143	Tello - custom made		tuš kad za vgradnjo ali postavitve na tla iz Kerrocka / ugradbena kada za tuširanje ili instalacija na pod, od Kerrocka	po ponudbi po ponudi	
			- dimenzija po meri - prilagođena dimenzija - položaj sifona po meri - prilagođeni položaj sifona - oblika po izmeri - oblik po mjeri Priložen / priložen Sifon Ø 90 s kerrock pokrovom H=60 mm. Sifon Ø 90 s poklopcem od kerrocka H=60 mm.		

Tuš kadi
 Tuš kade

Program: Kerrock
kolpa·san
BY KERROCK

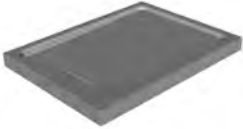
Model	Naziv in dimenzija izdelka Naziv i dimenzije produkta	Opis Opis	EAN koda EAN koda	Cena EUR Cijena EUR		
	Barva / Boja					
	Lavalta 160x90	- white 109	tuš kad za vgradnjo, postavitvev na tla ali v nivo tal iz Kerrocka ugradbena kada za tuširanje, instalacijo na pod ili u nivo poda od Kerrocka	3838987 561088	780,00	
	Lavalta 160x90	- andesite 9252		3838987 518143	897,00	
	Lavalta 160x80	- white 109		3838987 561071	585,00	
	Lavalta 160x80	- andesite 9252		3838987 518136	674,00	
	Lavalta 140x90	- white 109		3838987 561064	569,00	
	Lavalta 140x90	- andesite 9252		3838987 518129	655,00	
	Lavalta 140x80	- white 109		3838987 561057	510,00	
	Lavalta 140x80	- andesite 9252		3838987 518112	588,00	
	Lavalta 120x90	- white 109		3838987 561026	496,00	
	Lavalta 120x90	- andesite 9252		3838987 518105	569,00	
	Lavalta 120x80	- white 109		3838987 561019	437,00	
	Lavalta 120x80	- andesite 9252		3838987 518099	503,00	
		Lavalta 160x90/0		- white 109	tuš kad z oblogo iz Kerrocka kada za tuširanje s oblogom od Kerrocka	3838987 551409
Lavalta 160x90/0		- andesite 9252		3838987 551416		1.062,00
Lavalta 160x80/0		- white 109	3838987 551423	882,00		
Lavalta 160x80/0		- andesite 9252	3838987 551430	952,00		
Lavalta 140x90/0		- white 109	3838987 551362	855,00		
Lavalta 140x90/0		- andesite 9252	3838987 551379	924,00		
Lavalta 140x80/0		- white 109	3838987 551386	758,00		
Lavalta 140x80/0		- andesite 9252	3838987 551393	819,00		
Lavalta 120x90/0		- white 109	3838987 551324	734,00		
Lavalta 120x90/0		- andesite 9252	3838987 551331	773,00		
	Lavalta 100x100	- white 109	tuš kad za vgradnjo, postavitvev na tla ali v nivo tal iz Kerrocka ugradbena kada za tuširanje, instalacijo na pod ili u nivo poda od Kerrocka	3838987 561002	457,00	
	Lavalta 90x90	- white 109		3838987 560999	370,00	
	Lavalta 90x90	- andesite 9252		3838987 518082	424,00	
	Lavalta 100x100/0	- white 109	tuš kad z oblogo iz Kerrocka kada za tuširanje s oblogom od Kerrocka	3838987 551300	695,00	
	Lavalta 90x90/0	- white 109		3838987 551287	560,00	
	Lavalta 90x90/0	- andesite 9252		3838987 551294	606,00	
	Sifon Ø 52 brez pokrova H=65 mm	Sifon Ø 52 za tuš kadi, H=65 mm Sifon Ø 52 za tuš kade, H=65 mm	3838987 563174	14,00		

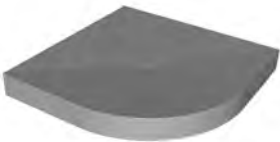





Tuš kadi
 Tuš kade

Tuš kadi Tuš kade		Program: Kerrock			kolpa·san®	
Model	Naziv in dimenzija izdelka Naziv i dimenzije produkta	Opis Opis	EAN koda EAN koda	Cena EUR Cijena EUR		
Lerock ZERO 120, 100, 90		Barva / Boja				
	Lerock ZERO 120x90 - white 109	tuš kad iz Kerrocka za vgradnjo z nivojem tal / ugradbena kada za tuširanje s razinom tla od Kerrocka priložen: /priložen: – visoko pretočni sifon Ø 52, visoko pretočni sifon Ø 52, – vodoodporna stop folija, vodoodporna stop folija, – stiropomi vložek. stiropor umetak.	3838987 570820	494,00		
	Lerock ZERO 120x80 - white 109		3838987 595991	457,00		
	Lerock ZERO 100x100 - white 109		3838987 570837	440,00		
	Lerock ZERO 90x90 - white 109		3838987 596011	391,00		
Ramona tray 120x90		Barva / Boja				
	Ramona tray 120x90 - white 108	tuš kad iz Kerrocka za postavev na tla kada od Kerrocka za tuširanje za instalacijo na pod	3838987 561118	757,00		
	Sifon Ø 52 brez pokrova H=65 mm	Sifon Ø 52 za tuš kadi, H=65 mm Sifon Ø 52 za tuš kade, H=65 mm	3838987 563174	14,00		
Lavolta R 100, 90		Barva / Boja				
	Lavolta 100x100 - white 109	tuš kad za postavev na tla, polkrožna, iz Kerrocka kada za tuširanje za instalacijo na pod, polukružna, od Kerrocka	3838987 561330	480,00		
	Lavolta 90x90 - white 109		3838987 561323	392,00		
	Lavolta 90x90 - andesite 9252		3838987 518075	449,00		
	Lavolta 100x100/0 - white 109	tuš kad z oblogo iz Kerrocka kada za tuširanje s oblogom od Kerrocka	3838987 551263	685,00		
	Lavolta 90x90/0 - white 109		3838987 551249	548,00		
	Lavolta 90x90/0 - andesite 9252		3838987 551256	593,00		
	Sifon Ø 52 brez pokrova H=65 mm	Sifon Ø 52 za tuš kadi, H=65 mm Sifon Ø 52 za tuš kade, H=65 mm	3838987 563174	14,00		

Tuš kadi
Tuš kade







Program: Liti marmor



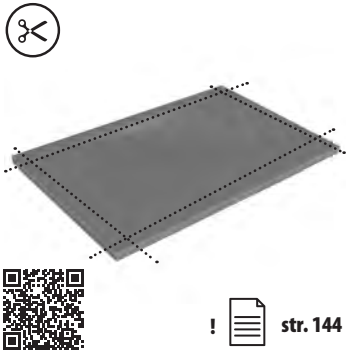



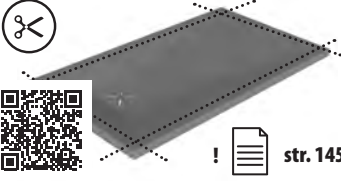

kolpa·san
BY KOLPA

Model	Naziv in dimenzija izdelka Naziv i dimenzije produkta	Opis Opis	EAN koda EAN koda	Cena EUR Cijena EUR
Moonwalk 140, 120, 100, 90				
	Barva / Boja			
	Moonwalk 140x90 - white	tuš kad za vgradnjo, postavitve na tla ali v nivo tal iz LM, reliefna površina ugradbena kada za tuširanje, instalacijo na pod ili u nivo poda od LM, reliefnom površinom	3838987 596837	375,00
	Moonwalk 140x90 - antracit		3838987 596844	375,00
	Moonwalk 140x90 - manhattan		3838987 596868	375,00
	Moonwalk 140x80 - white		3838987 597070	351,00
	Moonwalk 140x80 - antracit		3838987 597087	351,00
	Moonwalk 140x80 - manhattan		3838987 597100	351,00
	Moonwalk 120x90 - white	tuš kad za vgradnjo, postavitve na tla ali v nivo tal iz LM, reliefna površina ugradbena kada za tuširanje, instalacijo na pod ili u nivo poda od LM, reliefnom površinom	3838987 596912	338,00
	Moonwalk 120x90 - antracit		3838987 596929	338,00
	Moonwalk 120x90 - manhattan		3838987 596943	338,00
	Moonwalk 120x80 - white		3838987 597032	328,00
	Moonwalk 120x80 - antracit		3838987 597049	328,00
	Moonwalk 120x80 - manhattan		3838987 597063	328,00
	Moonwalk 100x90 - white	tuš kad za vgradnjo, postavitve na tla ali v nivo tal iz LM, reliefna površina ugradbena kada za tuširanje, instalacijo na pod ili u nivo poda od LM, reliefnom površinom	3838987 597117	299,00
	Moonwalk 100x90 - antracit		3838987 597124	299,00
	Moonwalk 100x90 - manhattan		3838987 597148	299,00
	Moonwalk 100x80 - white		3838987 596998	288,00
	Moonwalk 100x80 - antracit		3838987 597001	288,00
	Moonwalk 100x80 - manhattan		3838987 597025	288,00
	Moonwalk 100x100 - white	tuš kad za vgradnjo, postavitve na tla ali v nivo tal iz LM, reliefna površina ugradbena kada za tuširanje, instalacijo na pod ili u nivo poda od LM, reliefnom površinom	3838987 596950	319,00
	Moonwalk 100x100 - antracit		3838987 596967	319,00
	Moonwalk 100x100 - manhattan		3838987 596981	319,00
	Moonwalk 90x90 - white		3838987 596875	288,00
	Moonwalk 90x90 - antracit		3838987 596882	288,00
	Moonwalk 90x90 - manhattan		3838987 596905	288,00
	Sifon Ø 90 brez pokrova H=65 mm	Sifon Ø 90 za tuš kadi, H=65 mm Sifon Ø 90 za tuš kade, H=65 mm	3838987 563181	19,00
	Sifon Ø 90 brez pokrova H=84 mm	Sifon Ø 90 za tuš kadi, H=84 mm Sifon Ø 90 za tuš kade, H=84 mm	3838987 927723	16,00
 9 x	Podnožje tuš kadi LM	Podnožje tuš kadi LM, (9 nogic) Podnožje za tuš kade LM, (9 nožica)	3838987 563150	37,00



Tuš kadi
Tuš kade

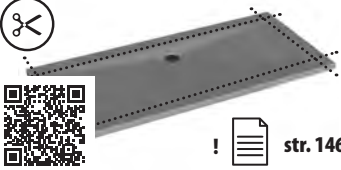









Tuš kadi Tuš kade		Program: Liti marmor			kolpa·san®	
Model	Naziv in dimenzija izdelka Naziv i dimenzije produkta	Opis Opis	EAN koda EAN koda	Cena EUR Cijena EUR		
Moonwalk 140, 120, 100, 90						
	Moonwalk 140x90	tuš kad za vgradnjo, postavitvev na tla ali v nivo tal iz LM, reliefna površina - prirez po meri ugradbena kada za tuširanje, instalacijo na pod ili u nivo poda od LM, reliefnom površinom - prilagođeno obrezivanje	3838987 932512	432,00		
	Moonwalk 140x80		3838987 932505	403,00		
	Moonwalk 120x90		3838987 932499	389,00		
	Moonwalk 120x80		3838987 932482	378,00		
	Moonwalk 100x100		3838987 932475	368,00		
	Moonwalk 100x90		3838987 932451	343,00		
	Moonwalk 100x80		3838987 932444	331,00		
Moonwalk 90x90	3838987 932437	331,00				
	Sifon Ø 90 brez pokrova H=65 mm	Sifon Ø 90 za tuš kadi, H=65 mm Sifon Ø 90 za tuš kade, H=65 mm	3838987 563181	19,00		
	Sifon Ø 90 brez pokrova H=84 mm	Sifon Ø 90 za tuš kadi, H=84 mm Sifon Ø 90 za tuš kade, H=84 mm	3838987 927723	16,00		
 9 x	Podnožje tuš kadi LM	Podnožje tuš kadi LM, (9 nogic) Podnožje za tuš kade LM, (9 nožica)	3838987 563150	37,00		
Limbo 140, 120						
Barva / Boja						
	Limbo 140x90	- white	tuš kad za vgradnjo, postavitvev na tla ali v nivo tal iz LM, reliefna površina ugradbena kada za tuširanje, instalacijo na pod ili u nivo poda od LM, reliefnom površinom	3838987 551218	396,00	
	Limbo 140x90	- antracit		3838987 551232	396,00	
	Limbo 140x90	- manhattan		3838987 551225	396,00	
	Limbo 140x80	- white		3838987 551188	374,00	
	Limbo 140x80	- antracit		3838987 551201	374,00	
	Limbo 140x80	- manhattan		3838987 551195	374,00	
	Limbo 120x90	- white	tuš kad za vgradnjo, postavitvev na tla ali v nivo tal iz LM, reliefna površina ugradbena kada za tuširanje, instalacijo na pod ili u nivo poda od LM, reliefnom površinom	3838987 551157	357,00	
	Limbo 120x90	- antracit		3838987 551171	357,00	
	Limbo 120x90	- manhattan		3838987 551164	357,00	
	Limbo 120x80	- white		3838987 551126	343,00	
	Limbo 120x80	- antracit		3838987 551140	343,00	
	Limbo 120x80	- manhattan		3838987 551133	343,00	
	Sifon Ø 90 brez pokrova H=65 mm	Sifon Ø 90 za tuš kadi, H=65 mm Sifon Ø 90 za tuš kade, H=65 mm	3838987 563181	19,00		
	Sifon Ø 90 brez pokrova H=84 mm	Sifon Ø 90 za tuš kadi, H=84 mm Sifon Ø 90 za tuš kade, H=84 mm	3838987 927723	16,00		
 9 x	Podnožje tuš kadi LM	Podnožje tuš kadi LM, (9 nogic) Podnožje za tuš kade LM, (9 nožica)	3838987 563150	37,00		









Tuš kadi Tuš kade		Program: Liti marmor		kolpa·san®	
Model	Naziv in dimenzija izdelka Naziv i dimenzije produkta	Opis Opis	EAN koda EAN koda	Cena EUR Cijena EUR	
Limbo 140, 120					
	Limbo 140x90	tuš kad za vgradnjo, postavitve na tla ali v nivo tal iz LM, reliefna površina - prerez po meri ugradbena kada za tuširanje, instalacijo na pod ili u nivo poda od LM, reliefnom površinom - prilagođeno obrezivanje	3838987 518181	455,00	
	Limbo 140x80		3838987 518174	431,00	
	Limbo 120x90		3838987 518167	412,00	
	Limbo 120x80		3838987 518150	396,00	
	Sifon Ø 90 brez pokrova H=65 mm	Sifon Ø 90 za tuš kadi, H=65 mm Sifon Ø 90 za tuš kade, H=65 mm	3838987 563181	19,00	
	Sifon Ø 90 brez pokrova H=84 mm	Sifon Ø 90 za tuš kadi, H=84 mm Sifon Ø 90 za tuš kade, H=84 mm	3838987 927723	16,00	
 9 x	Podnožje tuš kadi LM	Podnožje tuš kadi LM, (9 nogic) Podnožje za tuš kade LM, (9 nožica)	3838987 563150	37,00	
Stiletto 130x90					
	Barva / Boja				
	Stiletto 130x90	- white	tuš kad za vgradnjo, postavitve na tla ali v nivo tal iz LM, reliefna površina ugradbena kada za tuširanje, instalacijo na pod ili u nivo poda od LM, reliefnom površinom	3838987 922797	387,00
	Stiletto 130x90	- antracit		3838987 927082	387,00
Stiletto 130x90	- manhattan	3838987 925132		387,00	
	Sifon Ø 52 brez pokrova H=65 mm	Sifon Ø 52 za tuš kadi, H=65 mm Sifon Ø 52 za tuš kade, H=65 mm	3838987 563174	14,00	
 9 x	Podnožje tuš kadi LM	Podnožje tuš kadi LM, (9 nogic) Podnožje za tuš kade LM, (9 nožica)	3838987 563150	37,00	
Re-Walk 180, 140					
	Re-Walk 180x80	tuš kad za vgradnjo, postavitve na tla ali v nivo tal iz LM ugradbena kada za tuširanje, instalacijo na pod ili u nivo poda od LM	3838987 597803	418,00	
	Re-Walk 140x90		3838987 563129	384,00	
	Re-Walk 140x80		3838987 597254	360,00	
	Re-Walk 180x80	tuš kad za vgradnjo, postavitve na tla ali v nivo tal iz LM - prerez po meri ugradbena kada za tuširanje, instalacijo na pod ili u nivo poda od LM - prilagođeno obrezivanje	3838987 570806	481,00	
	Re-Walk 140x90		3838987 570691	442,00	
	Re-Walk 140x80		3838987 570813	415,00	
	Sifon Ø 90 s pokrovom H=65 mm	sifon Ø 90 za tuš kadi, H=65 mm sifon Ø 90 za tuš kade, H=65 mm	3838987 519904	26,00	
	Sifon Ø 90 s pokrovom H=84 mm	sifon Ø 90 za tuš kadi, H=84 mm sifon Ø 90 za tuš kade, H=84 mm	3838987 925873	17,00	
 12 x	Podnožje tuš kadi RE-WALK	Podnožje tuš kadi RE-WALK, (12 nogic) Podnožje za tuš kade RE-WALK, (12 nožica)	3838987 563167	47,00	



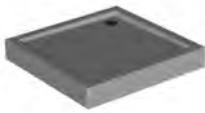



Tuš kadi Tuš kade		Program: Liti marmor		kolpa·san <small>BY KOLPA</small>	
Model	Naziv in dimenzija izdelka Naziv i dimenzije produkta	Opis Opis	EAN koda EAN koda	Cena EUR Cijena EUR	
Tobas 140, 120, 100, 90					
	Tobas 140x90	tuš kad za vgradnjo, postavitvev na tla ali v nivo tal iz LM ugradbena kada za tuširanje, instalaciju na pod ili u nivo poda od LM	3838987 605430	241,00	
	Tobas 140x80		3838987 605485	235,00	
	Tobas 120x90		3838987 605492	214,00	
	Tobas 120x80		3838987 605461	202,00	
	Tobas 100x90	tuš kad za vgradnjo, postavitvev na tla ali v nivo tal iz LM ugradbena kada za tuširanje, instalaciju na pod ili u nivo poda od LM	3838987 605454	193,00	
	Tobas 100x80		3838987 605478	184,00	
Tobas 90x90	3838987 605447		184,00		
	Sifon Ø 90 brez pokrova H=65 mm	Sifon Ø 90 za tuš kadi, H=65 mm Sifon Ø 90 za tuš kade, H=65 mm	3838987 563181	19,00	
	Sifon Ø 90 brez pokrova H=84 mm	Sifon Ø 90 za tuš kadi, H=84 mm Sifon Ø 90 za tuš kade, H=84 mm	3838987 927723	16,00	
	Podnožje Tobas 140x90	Podnožje tuš kadi LM Podnožje za tuš kade LM	3838987 594574	139,00	
	Podnožje Tobas 140x80		3838987 594734	137,00	
	Podnožje Tobas 120x90		3838987 594550	133,00	
	Podnožje Tobas 120x80		3838987 594727	131,00	
	Podnožje Tobas 100x90	Podnožje tuš kadi LM Podnožje za tuš kade LM	3838987 594710	119,00	
	Podnožje Tobas 100x80		3838987 594703	117,00	
Podnožje Tobas 90x90	3838987 594697		117,00		







Tuš kadi Tuš kade		Program: Liti marmor		kolpa·san <small>BY KOLPA</small>	
Model	Naziv in dimenzija izdelka Naziv i dimenzije produkta	Opis Opis	EAN koda EAN koda	Cena EUR Cijena EUR	
Capo 140, 120, 100, 90					
	Capo 140x100	tuš kad za vgradnjo, postavitvev na tla ali v nivo tal iz LM ugradbena kada za tuširanje, instalacijo na pod ili u nivo poda od LM	3838987 565086	394,00	
	Capo 140x90		3838987 565079	373,00	
	Capo 120x90		3838987 565062	341,00	
	Capo 120x80		3838987 565048	323,00	
	Capo 100x80		3838987 565031	294,00	
	Capo 90x90		3838987 565055	294,00	
	Sifon Ø 90 brez pokrova H=65 mm	Sifon Ø 90 za tuš kadi, H=65 mm Sifon Ø 90 za tuš kade, H=65 mm	3838987 563181	19,00	
	Sifon Ø 90 brez pokrova H=84 mm	Sifon Ø 90 za tuš kadi, H=84 mm Sifon Ø 90 za tuš kade, H=84 mm	3838987 927723	16,00	
 9 x	Podnožje tuš kadi LM	Podnožje tuš kadi LM, (9 nogic) Podnožje za tuš kade LM, (9 nožica)	3838987 563150	37,00	
Acro 140, 120, 100					
	Acro 140x90	tuš kad za vgradnjo, postavitvev na tla ali v nivo tal iz LM ugradbena kada za tuširanje, instalacijo na pod ili u nivo poda od LM	3838987 560982	381,00	
	Acro 140x80		3838987 560975	363,00	
	Acro 120x90		3838987 560968	349,00	
	Acro 120x80		3838987 560951	331,00	
	Acro 100x90		3838987 560944	317,00	
	Acro 100x80		3838987 560937	294,00	
	Sifon Ø 90 brez pokrova H=65 mm	Sifon Ø 90 za tuš kadi, H=65 mm Sifon Ø 90 za tuš kade, H=65 mm	3838987 563181	19,00	
	Sifon Ø 90 brez pokrova H=84 mm	Sifon Ø 90 za tuš kadi, H=84 mm Sifon Ø 90 za tuš kade, H=84 mm	3838987 927723	16,00	
 9 x	Podnožje tuš kadi LM	Podnožje tuš kadi LM, (9 nogic) Podnožje za tuš kade LM, (9 nožica)	3838987 563150	37,00	
Pandora tray 120, 100, 90					
	Pandora tray 120x90	tuš kad za vgradnjo, postavitvev na tla ali v nivo tal iz LM ugradbena kada za tuširanje, instalacijo na pod ili u nivo poda od LM	3838987 560913	344,00	
	Pandora tray 120x80		3838987 560906	328,00	
	Pandora tray 100x90		3838987 560890	312,00	
	Pandora tray 100x80		3838987 560883	296,00	
	Pandora tray 90x90		3838987 560869	296,00	
	Sifon Ø 90 brez pokrova H=65 mm	Sifon Ø 90 za tuš kadi, H=65 mm Sifon Ø 90 za tuš kade, H=65 mm	3838987 563181	19,00	
	Sifon Ø 90 brez pokrova H=84 mm	Sifon Ø 90 za tuš kadi, H=84 mm Sifon Ø 90 za tuš kade, H=84 mm	3838987 927723	16,00	
 9 x	Podnožje tuš kadi LM	Podnožje tuš kadi LM, (9 nogic) Podnožje za tuš kade LM, (9 nožica)	3838987 563150	37,00	

Tuš kadi Tuš kade		Program: Liti marmor		kolpa·san® BY KOLPA	
Model	Naziv in dimenzija izdelka Naziv i dimenzije produkta	Opis Opis	EAN koda EAN koda	Cena EUR Cijena EUR	
Canary 140, 120, 100, 90, 80					
	Canary 140x90	tuš kad za vgradnjo, postavitve na tla ali v nivo tal iz LM, ugradbena kada za tuširanje, instalacijo na pod ili u nivo poda od LM,	3838987 597247	309,00	
	Canary 120x90		3838987 597230	273,00	
	Canary 120x80		3838987 597209	258,00	
	Canary 100x80		3838987 597186	235,00	
	Canary 90x75		3838987 597162	207,00	
	Canary 140x90/0	tuš kad z oblogo iz LM kada za tuširanje s oblogom od LM	3838987 534570	498,00	
	Canary 120x90/0		3838987 534518	454,00	
	Canary 120x80/0		3838987 534549	436,00	
	Canary 100x80/0		3838987 534488	403,00	
	Canary 90x75/0		3838987 534457	360,00	
	Canary 100x100	tuš kad za vgradnjo, postavitve na tla ali v nivo tal iz LM ugradbena kada za tuširanje, instalacijo na pod ili u nivo poda od LM	3838987 597223	269,00	
	Canary 90x90		3838987 597193	235,00	
	Canary 80x80		3838987 922773	212,00	
	Canary 100x100/0	tuš kad z oblogo iz LM kada za tuširanje s oblogom od LM	3838987 534426	421,00	
	Canary 90x90/0		3838987 534396	400,00	
	Canary 80x80/0		3838987 923794	378,00	
	Sifon Ø 90 s pokrovom H=65 mm	sifon Ø 90 za tuš kadi, H=65 mm sifon Ø 90 za tuš kade, H=65 mm	3838987 519904	26,00	
	Sifon Ø 90 s pokrovom H=84 mm	sifon Ø 90 za tuš kadi, H=84 mm sifon Ø 90 za tuš kade, H=84 mm	3838987 925873	17,00	
 9 x	Podnožje tuš kadi LM	Podnožje tuš kadi LM, (9 nogic) Podnožje za tuš kade LM, (9 nožica)	3838987 563150	37,00	
Moonwalk R 100, 90					
Barva / Boja					
	Moonwalk 100x100 - white	tuš kad za vgradnjo ali postavitve na tla iz LM, reliefna površina ugradbena kada za tuširanje ili instalacijo na pod od LM, reliefnom površinom	3838987 922766	316,00	
	Moonwalk 100x100 - antracit		3838987 922902	316,00	
	Moonwalk 100x100 - manhattan		3838987 922896	316,00	
	Moonwalk 90x90 - white		3838987 922780	285,00	
	Moonwalk 90x90 - antracit		3838987 922889	285,00	
	Moonwalk 90x90 - manhattan		3838987 922872	285,00	
	Sifon Ø 90 brez pokrova H=65 mm	Sifon Ø 90 za tuš kadi, H=65 mm Sifon Ø 90 za tuš kade, H=65 mm	3838987 563181	19,00	
	Sifon Ø 90 brez pokrova H=84 mm	Sifon Ø 90 za tuš kadi, H=84 mm Sifon Ø 90 za tuš kade, H=84 mm	3838987 927723	16,00	
 9 x	Podnožje tuš kadi LM	Podnožje tuš kadi LM, (9 nogic) Podnožje za tuš kade LM, (9 nožica)	3838987 563150	37,00	



Tuš kadi Tuš kade		Program: Liti marmor		kolpa·san®	
Model	Naziv in dimenzija izdelka Naziv i dimenzije produkta	Opis Opis	EAN koda EAN koda	Cena EUR Cijena EUR	
Macarena 100, 90					
	Macarena 100x100	tuš kad za vgradnjo ali postavitev na tla, polkrožna iz LM ugradbena kada za tuširanje ili instalaciju na pod, polukružna od LM	3838987 597216	267,00	
	Macarena 90x90		3838987 597179	231,00	
	Macarena 100x100/0	tuš kad z oblogo, polkrožna iz LM kada za tuširanje s oblogom, polukružna od LM	3838987 534631	411,00	
	Macarena 90x90/0		3838987 534600	383,00	
	Sifon Ø 90 s pokrovom H=65 mm	sifon Ø 90 za tuš kadi, H=65 mm sifon Ø 90 za tuš kade, H=65 mm	3838987 519904	26,00	
	Sifon Ø 90 s pokrovom H=84 mm	sifon Ø 90 za tuš kadi, H=84 mm sifon Ø 90 za tuš kade, H=84 mm	3838987 925873	17,00	
 9 x	Podnožje tuš kadi LM	Podnožje tuš kadi LM, (9 nogic) Podnožje za tuš kade LM, (9 nožica)	3838987 563150	37,00	

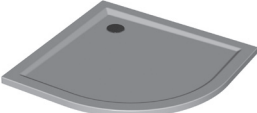
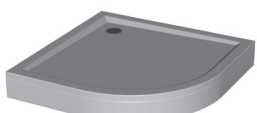



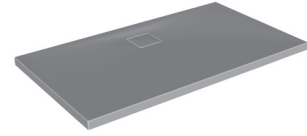
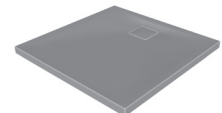

Masažne kabine, stene
Masažne kabine, stijene

Serra 140, 120, 90		Program: Modificiran akril		kolpa·san®	
	Barva / Boja				
	Serra 140x90	- white	tuš kad za vgradnjo ali postavitev na tla, reliefna površina ugradbena kada za tuširanje ili instalaciju na pod, reljefnom površinom	3838987 576297	272,00
	Serra 140x90	- graphite		3838987 576273	272,00
	Serra 140x80	- white		3838987 576389	248,00
	Serra 140x80	- graphite		3838987 576365	248,00
	Serra 120x90	- white		3838987 576327	239,00
	Serra 120x90	- graphite		3838987 576303	239,00
	Serra 120x80	- white		3838987 576419	214,00
	Serra 120x80	- graphite		3838987 576396	214,00
	Serra 90x90	- white	3838987 576440	183,00	
	Serra 90x90	- graphite	3838987 576426	183,00	
	Sifon Ø 90 brez pokrova H=65 mm	Sifon Ø 90 za tuš kadi, H=65 mm Sifon Ø 90 za tuš kade, H=65 mm	3838987 563181	19,00	
	Sifon Ø 90 brez pokrova H=84 mm	Sifon Ø 90 za tuš kadi, H=84 mm Sifon Ø 90 za tuš kade, H=84 mm	3838987 927723	16,00	
		www.kolpasan.si	www.kolpasan.hr	133	

Tuš kadi Tuš kade		Program: Liti marmor			kolpa·san [®] <small>by KOLPA</small>	
Model	Naziv in dimenzija izdelka Naziv i dimenzije produkta	Opis Opis	EAN koda EAN koda	Cena EUR Cijena EUR		
Macarena 100, 90						
	Macarena 100x100	tuš kad za vgradnjo ali postavitev na tla, polkrožna iz LM ugradbena kada za tuširanje ili instalaciju na pod, polukružna od LM	3838987 597216	267,00		
	Macarena 90x90		3838987 597179	231,00		
	Macarena 100x100/0	tuš kad z oblogo, polkrožna iz LM kada za tuširanje s oblogom, polukružna od LM	3838987 534631	411,00		
	Macarena 90x90/0		3838987 534600	383,00		
	Sifon Ø 90 s pokrovom H=65 mm	sifon Ø 90 za tuš kadi, H=65 mm sifon Ø 90 za tuš kade, H=65 mm	3838987 519904	26,00		
	Sifon Ø 90 s pokrovom H=84 mm	sifon Ø 90 za tuš kadi, H=84 mm sifon Ø 90 za tuš kade, H=84 mm	3838987 925873	17,00		
 9 x	Podnožje tuš kadi LM	Podnožje tuš kadi LM, (9 nogic) Podnožje za tuš kade LM, (9 nožica)	3838987 563150	37,00		





Tuš kadi
Tuš kade

Serra 140, 120, 90		Program: Modificiran akril			kolpa·san [®] <small>by KOLPA</small>	
	Barva / Boja					
	Serra 140x90	- white	tuš kad za vgradnjo ali postavitev na tla, reliefna površina ugradbena kada za tuširanje ili instalaciju na pod, reliefnom površinom	3838987 576297	272,00	
	Serra 140x90	- graphite		3838987 576273	272,00	
	Serra 140x80	- white		3838987 576389	248,00	
	Serra 140x80	- graphite		3838987 576365	248,00	
	Serra 120x90	- white		3838987 576327	239,00	
	Serra 120x90	- graphite		3838987 576303	239,00	
	Serra 120x80	- white		3838987 576419	214,00	
	Serra 120x80	- graphite		3838987 576396	214,00	
	Serra 90x90	- white	3838987 576440	183,00		
	Serra 90x90	- graphite	3838987 576426	183,00		
	Sifon Ø 90 brez pokrova H=65 mm	Sifon Ø 90 za tuš kadi, H=65 mm Sifon Ø 90 za tuš kade, H=65 mm	3838987 563181	19,00		
	Sifon Ø 90 brez pokrova H=84 mm	Sifon Ø 90 za tuš kadi, H=84 mm Sifon Ø 90 za tuš kade, H=84 mm	3838987 927723	16,00		
		www.kolpasan.si	www.kolpasan.hr	133		





Tuš kadi Tuš kade	Program: Liti sanitarni akril			
Model	Naziv in dimenzija izdelka Naziv i dimenzije produkta	Opis Opis	EAN koda EAN koda	Cena EUR Cijena EUR
Drop 140, 120, 100, 90, 80				
	Drop 140x90 Drop 140x80 Drop 120x90 Drop 120x80	tuš kad za vgradnjo ali postavev na tla ugradbena kada za tuširanje ili instalaciju na pod	3838987 565666 3838987 565659 3838987 565673 3838987 565642	267,00 261,00 256,00 243,00
	Drop 140x90/0 Drop 140x80/0 Drop 120x90/0 Drop 120x80/0	tuš kad z oblogo kada za tuširanje s oblogom	3838987 566038 3838987 566021 3838987 566014 3838987 566007	366,00 359,00 353,00 338,00
	Drop 100x90 Drop 100x80 Drop 90x90 Drop 80x80	tuš kad za vgradnjo ali postavev na tla ugradbena kada za tuširanje ili instalaciju na pod	3838987 565949 3838987 565635 3838987 565611 3838987 565604	236,00 217,00 214,00 190,00
	Drop 100x90/0 Drop 100x80/0 Drop 90x90/0 Drop 80x80/0	tuš kad z oblogo kada za tuširanje s oblogom	3838987 565994 3838987 565987 3838987 565970 3838987 565932	335,00 312,00 310,00 288,00
	Sifon Ø 52 brez pokrova H=65 mm	Sifon Ø 52 za tuš kadi, H=65 mm Sifon Ø 52 za tuš kade, H=65 mm	3838987 563174	14,00









Tuš kadi
 Tuš kade

Program: Liti sanitarni akril
kolpa·san
BY ROCK









Model	Naziv in dimenzija izdelka Naziv i dimenzije produkta	Opis Opis	EAN koda EAN koda	Cena EUR Cijena EUR
Flamenco 180, 170, 160, 140, 130, 120				
	Flamenco 180x80 Flamenco 170x80 Flamenco 170x75 Flamenco 160x90 Flamenco 160x80 Flamenco 160x70	tuš kad za vgradnjo ugradbena kada za tuširanje	3838987 782186 3838987 782193 3838987 999720 3838987 785668 3838987 572787 3838987 999713	334,00 299,00 296,00 275,00 273,00 271,00
	Flamenco 180x80/0 Flamenco 170x80/0 Flamenco 170x75/0 Flamenco 160x90/0 Flamenco 160x80/0 Flamenco 160x70/0	tuš kad z oblogo kada za tuširanje s oblogom	3838987 534754 3838987 994923 3838987 534648 3838987 534617 3838987 572800 3838987 534587	495,00 461,00 459,00 436,00 434,00 432,00
	Flamenco 140x90 Flamenco 140x80 Flamenco 140x70 Flamenco 130x90 Flamenco 130x80 Flamenco 120x100 Flamenco 120x90 Flamenco 120x80 Flamenco 120x70	tuš kad za vgradnjo ugradbena kada za tuširanje	3838987 533863 3838987 572206 3838987 572770 3838987 533849 3838987 945871 3838987 576167 3838987 766148 3838987 785941 3838987 571094	260,00 257,00 254,00 257,00 254,00 259,00 251,00 237,00 235,00
	Flamenco 140x90/0 Flamenco 140x80/0 Flamenco 140x70/0 Flamenco 130x90/0 Flamenco 130x80/0 Flamenco 120x100/0 Flamenco 120x90/0 Flamenco 120x80/0 Flamenco 120x70/0	tuš kad z oblogo kada za tuširanje s oblogom	3838987 533870 3838987 572213 3838987 572794 3838987 533856 3838987 945888 3838987 576174 3838987 755548 3838987 919728 3838987 571100	360,00 355,00 350,00 355,00 350,00 359,00 348,00 334,00 332,00
	Sifon Ø 90 s pokrovom H=65 mm Sifon Ø 90 s pokrovom H=84 mm	sifon Ø 90 za tuš kadi, H=65 mm sifon Ø 90 za tuš kade, H=65 mm sifon Ø 90 za tuš kadi, H=84 mm sifon Ø 90 za tuš kade, H=84 mm	3838987 519904 3838987 925873	26,00 17,00





Tuš kadi
 Tuš kade

Tuš kadi Tuš kade		Program: Liti sanitarni akril			kolpa·san BY KOLPA	
Model	Naziv in dimenzija izdelka Naziv i dimenzije produkta	Opis Opis	EAN koda EAN koda	Cena EUR Cijena EUR		
Flamenco 110, 100, 90, 80, 70						
	Flamenco 110x90	tuš kad za vgradnjo ugradbena kada za tuširanje	3838987 533825	238,00		
	Flamenco 110x80		3838987 533801	226,00		
	Flamenco 100x100		3838987 961420	238,00		
	Flamenco 100x90		3838987 785620	231,00		
	Flamenco 100x80		3838987 571070	217,00		
	Flamenco 90x90		3838987 782636	210,00		
	Flamenco 90x80		3838987 596134	195,00		
	Flamenco 90x70		3838987 571131	186,00		
	Flamenco 80x80		3838987 518365	186,00		
	Flamenco 70x70		3838987 571117	180,00		
	Flamenco 110x90/0	tuš kad z oblogo kada za tuširanje s oblogom	3838987 533832	335,00		
	Flamenco 110x80/0		3838987 533818	323,00		
	Flamenco 100x100/0		3838987 961437	335,00		
	Flamenco 100x90/0		3838987 994800	331,00		
	Flamenco 100x80/0		3838987 571087	312,00		
	Flamenco 90x90/0		3838987 534761	306,00		
	Flamenco 90x80/0		3838987 596141	293,00		
	Flamenco 90x70/0		3838987 571148	284,00		
	Flamenco 80x80/0		3838987 518358	284,00		
	Flamenco 70x70/0		3838987 571124	274,00		
	Sifon Ø 90 s pokrovom H=65 mm	sifon Ø 90 za tuš kadi, H=65 mm sifon Ø 90 za tuš kade, H=65 mm	3838987 519904	26,00		
	Sifon Ø 90 s pokrovom H=84 mm		sifon Ø 90 za tuš kadi, H=84 mm sifon Ø 90 za tuš kade, H=84 mm	3838987 925873	17,00	
Funky 120, 100						
	Funky 120x90	tuš kad s sedežem za vgradnjo tuš kada sa sjedalom za ugradnju	3838987 592969	306,00		
	Funky 100x80		3838987 592945	267,00		
		priložena: /priložen: – odlivno/prelivna garnitura s sifonom UP&DOWN Ø 52, odlivno/prelivna garnitura sa sifonom UP&DOWN Ø 52				
	Funky 120x90/0	tuš kad s sedežem z oblogo tuš kada sa sjedalom sa oblogom	3838987 592952	526,00		
	Funky 100x80/0		3838987 592938	475,00		
		montirana: /namještena: – odlivno/prelivna garnitura s sifonom UP&DOWN Ø 52, odlivno/prelivna garnitura sa sifonom UP&DOWN Ø 52				







Tuš kadi Tuš kade	Program: Liti sanitarni akril		kolpa·san [®]	
Model	Naziv in dimenzija izdelka Naziv i dimenzije produkta	Opis Opis	EAN koda EAN koda	Cena EUR Cijena EUR
Evelin tray Q 120				
	Evelin tray Q 120x90 Evelin tray Q 120x80	tuš kad za vgradnjo ali postavev na tla ugradbena kada za tuširanje ili instalacijo na pod	3838987 593164 3838987 593324	203,00 189,00
	Evelin tray Q 120x90/0 Evelin tray Q 120x80/0	tuš kad z oblogo kada za tuširanje s oblogom	3838987 593171 3838987 593331	295,00 282,00
	Sifon Ø 90 s pokrovom H=65 mm Sifon Ø 90 s pokrovom H=84 mm	sifon Ø 90 za tuš kadi, H=65 mm sifon Ø 90 za tuš kade, H=65 mm sifon Ø 90 za tuš kadi, H=84 mm sifon Ø 90 za tuš kade, H=84 mm	3838987 519904 3838987 925873	26,00 17,00
Evelin tray Q 90, 80				
	Evelin tray Q 90x90 Evelin tray Q 80x80	tuš kad za vgradnjo ugradbena kada za tuširanje	3838987 593034 3838987 593287	111,00 103,00
	Evelin tray Q 90x90/0 Evelin tray Q 80x80/0	tuš kad z oblogo kada za tuširanje s oblogom	3838987 593041 3838987 593294	194,00 188,00
	Sifon Ø 90 s pokrovom H=65 mm Sifon Ø 90 s pokrovom H=84 mm	sifon Ø 90 za tuš kadi, H=65 mm sifon Ø 90 za tuš kade, H=65 mm sifon Ø 90 za tuš kadi, H=84 mm sifon Ø 90 za tuš kade, H=84 mm	3838987 519904 3838987 925873	26,00 17,00
Trin 90, 80				
	Trin 90x90 Trin 80x80	tuš kad za vgradnjo ugradbena kada za tuširanje	3838987 754817 3838987 754800	113,00 106,00
	Trin 90x90/0 Trin 80x80/0	tuš kad z oblogo kada za tuširanje s oblogom	3838987 755135 3838987 754893	196,00 190,00
	Sifon Ø 52 s pokrovom H=65 mm	Sifon Ø 52 za tuš kadi, H=65 mm Sifon Ø 52 za tuš kade, H=65 mm	3838987 512981	16,00



Tuš kadi Tuš kade	Program: Liti sanitarni akril			
Model	Naziv in dimenzija izdelka Naziv i dimenzije produkta	Opis Opis	EAN koda EAN koda	Cena EUR Cijena EUR
Malur 120, 100, -L				
	Malur 120x90 -L Malur 100x80 -L	tuš kad za vgradnjo, polkrožna, asimetrična ugradbena kada za tuširanje, polukružna, asimetrična	3838987 792826 3838987 793168	237,00 221,00
	Malur 120x90/0 -L Malur 100x80/0 -L	tuš kad z oblogo, polkrožna, asimetrična kada za tuširanje s oblogom, polukružna, asimetrična	3838987 537076 3838987 755555	334,00 316,00
	Sifon Ø 90 s pokrovom H=65 mm Sifon Ø 90 s pokrovom H=84 mm	sifon Ø 90 za tuš kadi, H=65 mm sifon Ø 90 za tuš kade, H=65 mm sifon Ø 90 za tuš kadi, H=84 mm sifon Ø 90 za tuš kade, H=84 mm	3838987 519904 3838987 925873	26,00 17,00
Malur 120, 100, -D				
	Malur 120x90 -D Malur 100x80 -D	tuš kad za vgradnjo, polkrožna, asimetrična ugradbena kada za tuširanje, polukružna, asimetrična	3838987 766254 3838987 793601	237,00 221,00
	Malur 120x90/0 -D Malur 100x80/0 -D	tuš kad z oblogo, polkrožna, asimetrična kada za tuširanje s oblogom, polukružna, asimetrična	3838987 537083 3838987 537069	334,00 316,00
	Sifon Ø 90 s pokrovom H=65 mm Sifon Ø 90 s pokrovom H=84 mm	sifon Ø 90 za tuš kadi, H=65 mm sifon Ø 90 za tuš kade, H=65 mm sifon Ø 90 za tuš kadi, H=84 mm sifon Ø 90 za tuš kade, H=84 mm	3838987 519904 3838987 925873	26,00 17,00
Drop R 90, 80				
	Drop R 90x90 Drop R 80x80	tuš kad za vgradnjo ali postavev na tla, polkrožna ugradbena kada za tuširanje ili instalacijo na pod, polukružna	3838987 565697 3838987 565680	209,00 184,00
	Drop R 90x90/0 Drop R 80x80/0	tuš kad z oblogo, polkrožna kada za tuširanje s oblogom, polukružna	3838987 566052 3838987 566045	305,00 282,00
	Sifon Ø 52 brez pokrova H=65 mm	Sifon Ø 52 za tuš kadi, H=65 mm Sifon Ø 52 za tuš kade, H=65 mm	3838987 563174	14,00

Tuš kadi Tuš kade		Program: Liti sanitarni akril			kolpa·san <small>BY KOLPA</small>	
Model	Naziv in dimenzija izdelka Naziv i dimenzije produkta	Opis Opis	EAN koda EAN koda	Cena EUR Cijena EUR		
Dixie 90						
	Dixie 90x90	tuš kad za vgradnjo, polkrožna, globina 30 cm ugradbena kada za tuširanje, polukružna, globina 30 cm	3838987 790075	214,00		
	Dixie 90x90/0	tuš kad z oblogo, polkrožna kada za tuširanje s oblogom, polukružna	3838987 788737	391,00		
	Sifon Ø 52 s pokrovom H=65 mm	Sifon Ø 52 za tuš kadi, H=65 mm Sifon Ø 52 za tuš kade, H=65 mm	3838987 512981	16,00		
SQ line TKP 90 /CH DIXIE						
	TKP 90 /CH DIXIE Silver SQ line	tuš kabina - polkrožna, za tuš kad Dixie, h=160, silver profili tuš kabina - polukružna, za tuš kadu Dixie, h=160, silver profili	3838987 511502	414,00		
	TKP 90 /CH DIXIE Bela SQ line	tuš kabina - polkrožna, za tuš kad Dixie, h=160, beli profili tuš kabina - polukružna, za tuš kadu Dixie, h=160, beli profili	3838987 511496	347,00		



Tuš kadi Tuš kade		Program: Liti sanitarni akril			kolpa·san <small>BY KOLPA</small>	
Model	Naziv in dimenzija izdelka Naziv i dimenzije produkta	Opis Opis	EAN koda EAN koda	Cena EUR Cijena EUR		
Evelin tray R 90, 80						
	Evelin tray R 90x90	tuš kad za vgradnjo, polkrožna ugradbena kada za tuširanje, polukružna	3838987 593058	111,00		
	Evelin tray R 80x80		3838987 593300	103,00		
	Evelin tray R 90x90/0	tuš kad z oblogo kada za tuširanje s oblogom	3838987 593065	194,00		
	Evelin tray R 80x80/0		3838987 593317	188,00		
	Sifon Ø 90 s pokrovom H=65 mm	sifon Ø 90 za tuš kadi, H=65 mm sifon Ø 90 za tuš kade, H=65 mm	3838987 519904	26,00		
	Sifon Ø 90 s pokrovom H=84 mm		sifon Ø 90 za tuš kadi, H=84 mm sifon Ø 90 za tuš kade, H=84 mm	3838987 925873	17,00	
Ontex 90, 80						
	Ontex 90x90	tuš kad za vgradnjo, polkrožna ugradbena kada za tuširanje, polukružna	3838987 754886	113,00		
	Ontex 80x80		3838987 754879	106,00		
	Ontex 90x90/0	tuš kad z oblogo, polkrožna kada za tuširanje s oblogom, polukružna	3838987 755159	196,00		
	Ontex 80x80/0		3838987 755142	190,00		
	Sifon Ø 52 s pokrovom H=65 mm	Sifon Ø 52 za tuš kadi, H=65 mm Sifon Ø 52 za tuš kade, H=65 mm	3838987 512981	16,00		

Customer:

Name and Surname	
Address	
E-mail	
Phone number	



Properties:

Model	BALLO		
Dimensions (AxB)	2000 x _____ mm		
Color	White		
Cutting option			

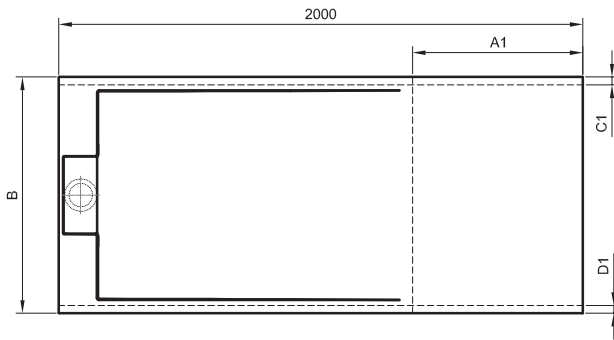

Option 1

A1 [mm]	max. 650mm	C1 [mm]	max. 30mm	D1 [mm]	max. 30mm
---------	------------	---------	-----------	---------	-----------

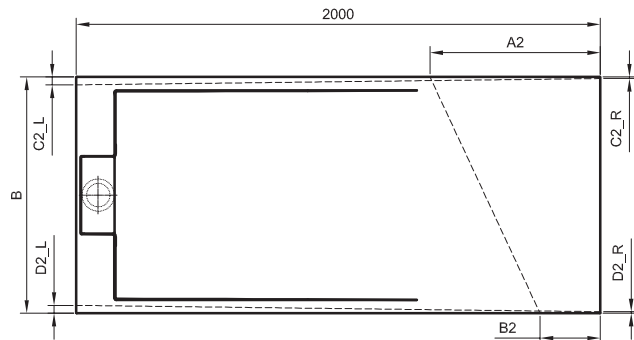

Option 2

A2 [mm]	max. 650mm	C2_L [mm]	max. 30mm	D2_L [mm]	max. 30mm
B2 [mm]		C2_R [mm]		D2_R [mm]	

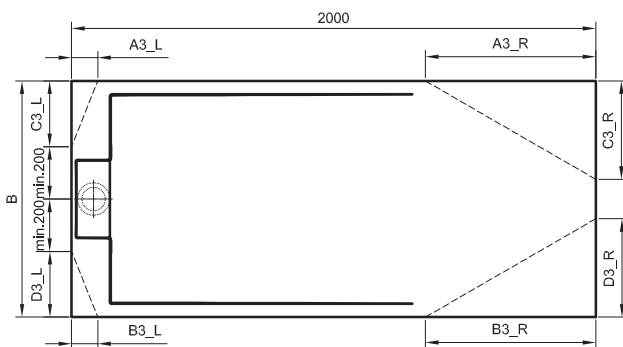

Option 3

A3_L [mm]	max. 100mm	A3_R [mm]	max. 650mm	C3_L [mm]	max. (B/2)-200mm
B3_L [mm]		B3_R [mm]		D3_L [mm]	
				C3_R [mm]	
				D3_R [mm]	

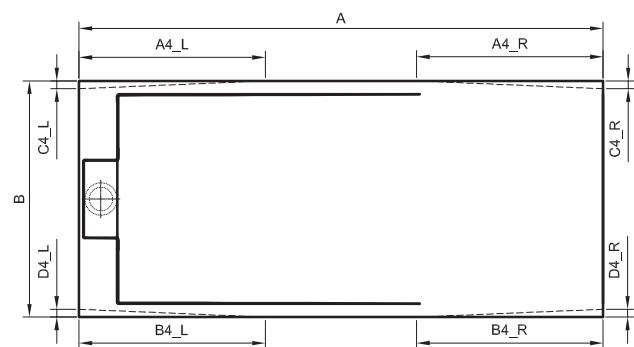

Option 4

A4_L [mm]		A4_R [mm]		C4_L [mm]	max. 30mm
B4_L [mm]		B4_R [mm]		D4_L [mm]	
				C4_R [mm]	max. 30mm
				D4_R [mm]	

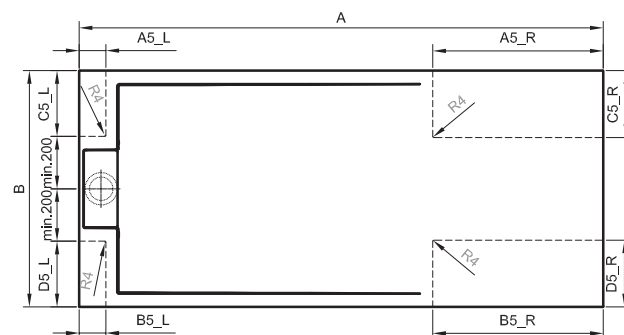

Option 5

A5_L [mm]	max. 120mm	A5_R [mm]	max. 650mm	C5_L [mm]	max. (B/2)-200mm
B5_L [mm]		B5_R [mm]		D5_L [mm]	max. B/3
				C5_R [mm]	
				D5_R [mm]	

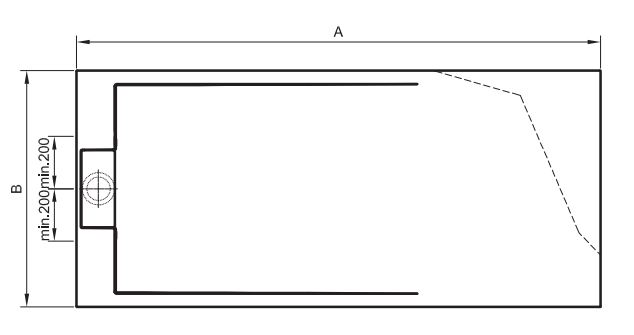

Option 6

Special requirements

- mark and quote the cuts in the image



Customer:

Name and Surname	
Address	
E-mail	
Phone number	

Properties:

Model	TELLO		
Dimensions (AxB)	_____ x _____ mm		
Color	White		
Cutting option			

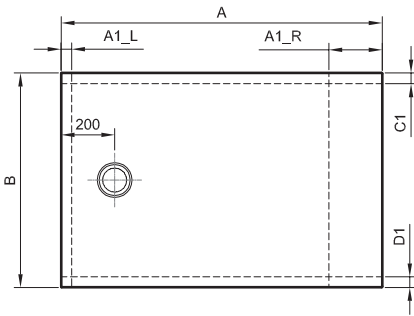

Option 1

	max. 40mm
A1_L [mm]	
	max. 200mm
A1_R [mm]	
	max. 40mm
C1 [mm]	
	max. 40mm
D1 [mm]	

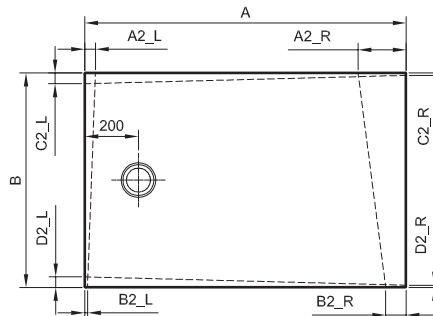

Option 2

	max. 40mm
A2_L [mm]	
	max. 200mm
B2_L [mm]	
	max. 40mm
C2_L [mm]	
	max. 40mm
D2_L [mm]	
	max. 40mm
D2_R [mm]	

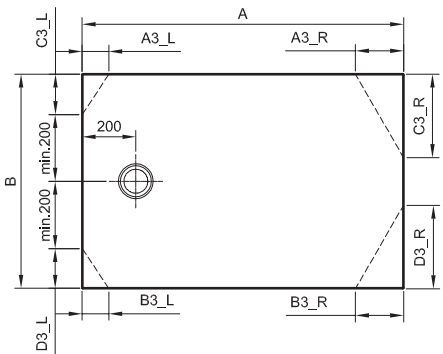

Option 3

	max. 100mm
A3_L [mm]	
	max. 180mm
B3_L [mm]	
	max. (A/2)-200mm
C3_L [mm]	
D3_L [mm]	
C3_R [mm]	
D3_R [mm]	

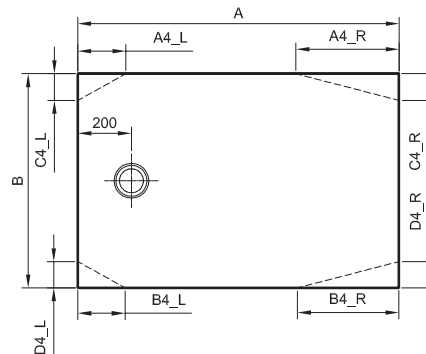

Option 4

	max. A/3
A4_L [mm]	
	max. A/3
B4_L [mm]	
	max. 100mm
C4_L [mm]	
	max. 100mm
D4_L [mm]	
	max. 100mm
C4_R [mm]	
D4_R [mm]	

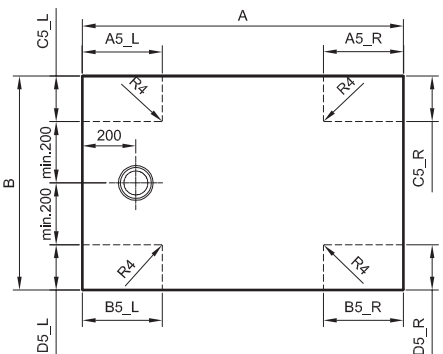

Option 5

	max. A/3
A5_L [mm]	
	max. A/3
B5_L [mm]	
	max. (B/2)-200mm
C5_L [mm]	
	max. B/3
D5_L [mm]	
	max. B/3
C5_R [mm]	
D5_R [mm]	

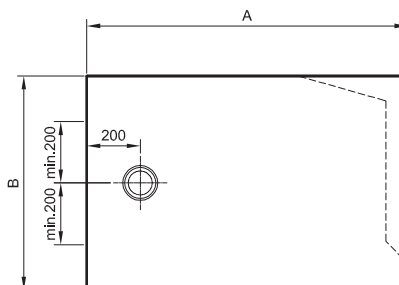

Option 6

Special requirements
<- mark and quote the cuts in the image

SHOWER TUB - CUSTOM MADE

Model	TELLO
	Custom made
Dimension (A x B)	
Color	



CUSTOMER	
Name and Surname	
Address	
E-mail	
Phone number	

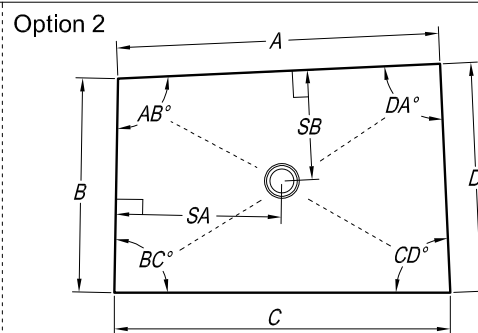
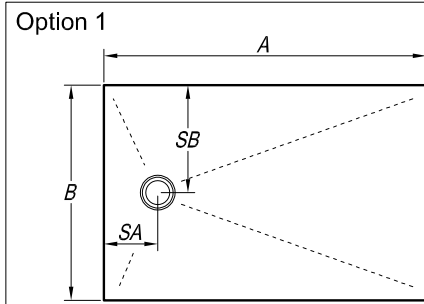

DIMENSIONS	
Option	
A	
B	
C	
D	
E	
R 550	

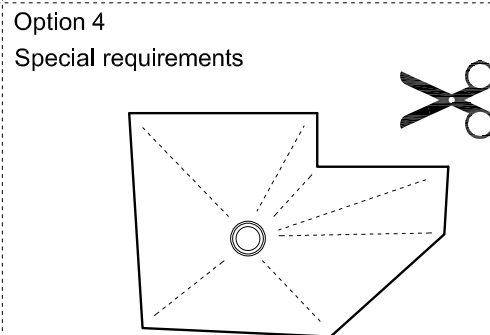
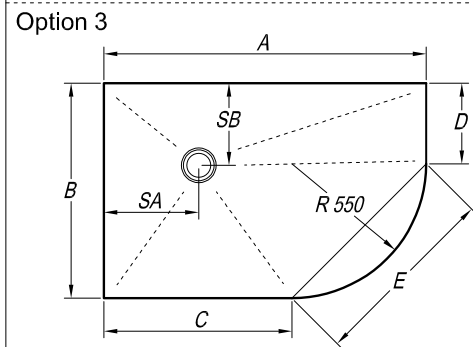

ANGLE (00,0°)	
AB°	
BC°	
CD°	
DA°	

MIDDLE OF OUTFLOW	
SA (min. 200)	
SB (min. 200)	

Special requirements

Sketch with dimensions



Customer:

Name and Surname	
Address	
E-mail	
Phone number	

Properties:

Model	MOONWALK		
Dimensions (AxB)	_____ x _____ mm		
Color	White	Antracit	Manhattan
Cutting option			

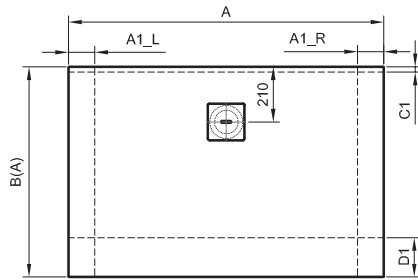

Option 1

	max. 100mm
A1_L [mm]	
A1_R [mm]	
	max. 20mm
C1 [mm]	
	max. 150mm
D1 [mm]	

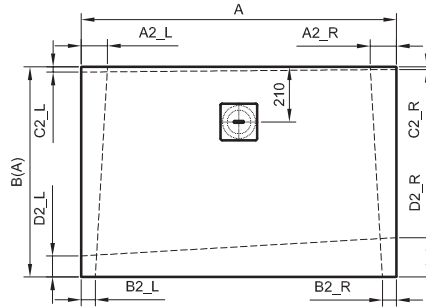

Option 2

	max. 100mm
A2_L [mm]	
A2_R [mm]	
	max. 100mm
B2_L [mm]	
B2_R [mm]	
	max. 20mm
C2_L [mm]	
C2_R [mm]	
	max. 150mm
D2_L [mm]	
D2_R [mm]	

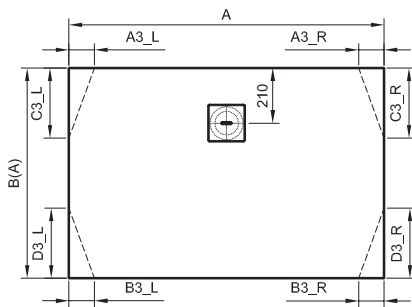

Option 3

	max. 100mm
A3_L [mm]	
A3_R [mm]	
	max. 100mm
B3_L [mm]	
B3_R [mm]	
C3_L [mm]	
C3_R [mm]	
D3_L [mm]	
D3_R [mm]	

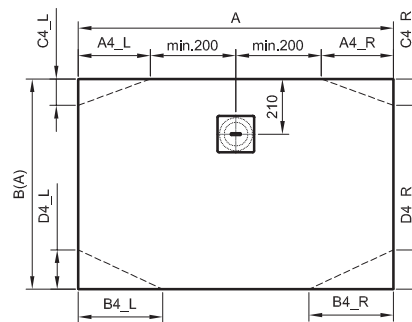

Option 4

	max. (A/2)-200mm
A4_L [mm]	
A4_R [mm]	
B4_L [mm]	
B4_R [mm]	
	max. 100mm
C4_L [mm]	
C4_R [mm]	
	max. 150mm
D4_L [mm]	
D4_R [mm]	

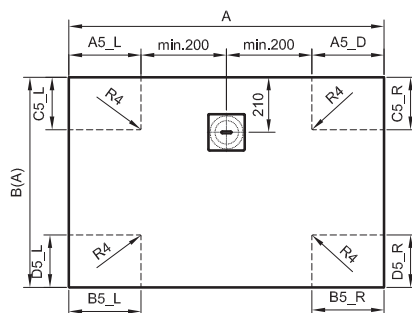

Option 5

	max. (A/2)-200mm
A5_L [mm]	
A5_R [mm]	
	max. A/3
B5_L [mm]	
B5_R [mm]	
	max. B(A)/3
C5_L [mm]	
C5_R [mm]	
	max. B(A)/3
D5_L [mm]	
D5_R [mm]	

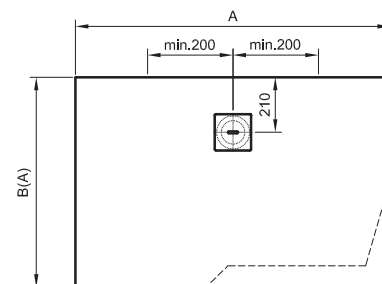

Option 6

Special requirements
<- mark and quote the cuts in the image

Customer:

Name and Surname	
Address	
E-mail	
Phone number	

Properties:

Model	LIMBO		
Dimensions (AxB)	_____ x _____ mm		
Color	White	Antracit	Manhattan
Cutting option			

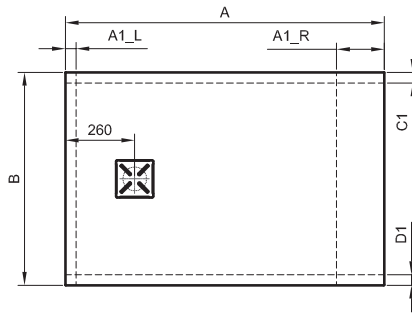

Option 1

	max. 40mm
A1_L [mm]	
	max. 180mm
A1_R [mm]	
	max. 40mm
C1 [mm]	
	max. 40mm
D1 [mm]	

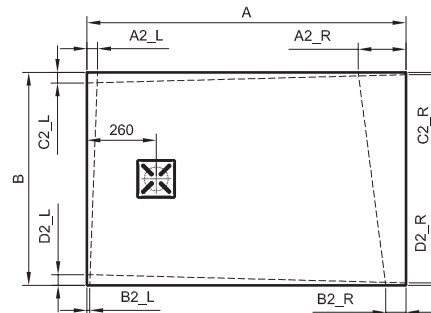

Option 2

	max. 40mm
A2_L [mm]	
B2_L [mm]	
	max. 180mm
A2_R [mm]	
B2_R [mm]	
	max. 40mm
C2_L [mm]	
C2_R [mm]	
	max. 40mm
D2_L [mm]	
D2_R [mm]	

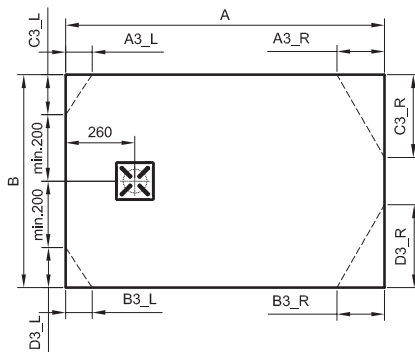

Option 3

	max. 100mm
A3_L [mm]	
B3_L [mm]	
	max. 180mm
A3_R [mm]	
B3_R [mm]	
	max. (B/2)-200mm
C3_L [mm]	
D3_L [mm]	
C3_R [mm]	
D3_R [mm]	

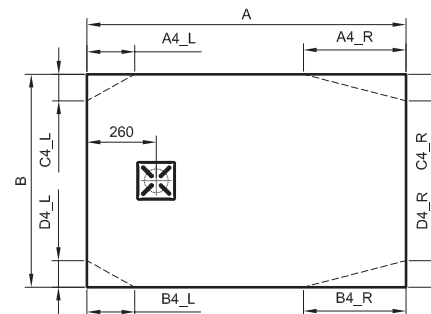

Option 4

	max. A/3
A4_L [mm]	
B4_L [mm]	
	max. A/3
A4_R [mm]	
B4_R [mm]	
	max. 100mm
C4_L [mm]	
D4_L [mm]	
	max. 100mm
C4_R [mm]	
D4_R [mm]	

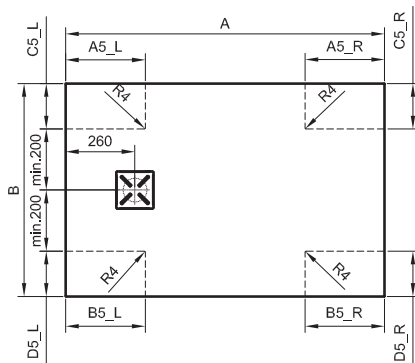

Option 5

	max. A/3
A5_L [mm]	
B5_L [mm]	
	max. A/3
A5_R [mm]	
B5_R [mm]	
	max. (B/2)-200mm
C5_L [mm]	
D5_L [mm]	
	max. B/3
C5_R [mm]	
D5_R [mm]	

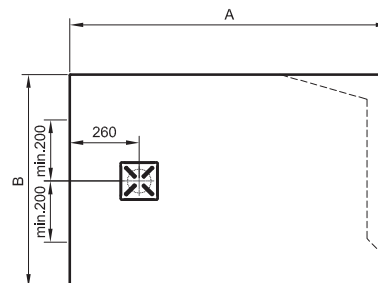

Option 6

Special requirements
<- mark and quote the cuts in the image



Customer:

Name and Surname	
Address	
E-mail	
Phone number	

Properties:

Model	RE-WALK		
Dimensions (AxB)	_____ x _____ mm		
Color	White		
Cutting option			

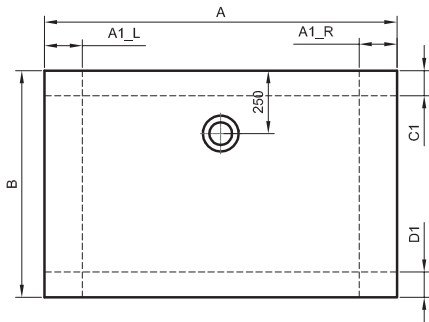

Option 1

	max. 150mm
A1_L [mm]	
A1_R [mm]	
	max. 100mm
C1 [mm]	
	max. 150mm
D1 [mm]	

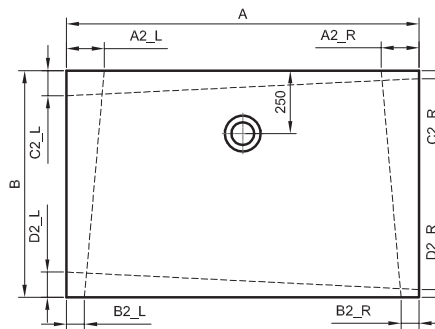

Option 2

	max. 150mm
A2_L [mm]	
A2_R [mm]	
	max. 150mm
B2_L [mm]	
B2_R [mm]	
	max. 100mm
C2_L [mm]	
C2_R [mm]	
	max. 150mm
D2_L [mm]	
D2_R [mm]	

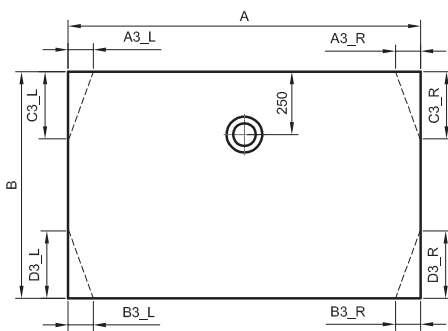

Option 3

	max. 150mm
A3_L [mm]	
A3_R [mm]	
	max. 150mm
B3_L [mm]	
B3_R [mm]	
C3_L [mm]	
C3_R [mm]	
D3_L [mm]	
D3_R [mm]	

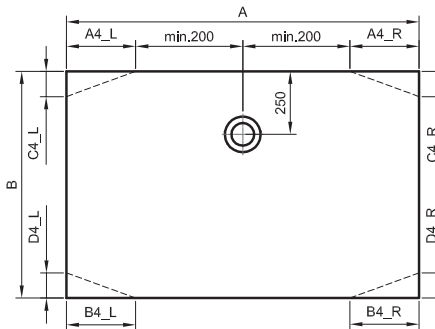

Option 4

	max. (A/2)-200mm
A4_L [mm]	
A4_R [mm]	
B4_L [mm]	
B4_R [mm]	
	max. 100mm
C4_L [mm]	
C4_R [mm]	
	max. 150mm
D4_L [mm]	
D4_R [mm]	

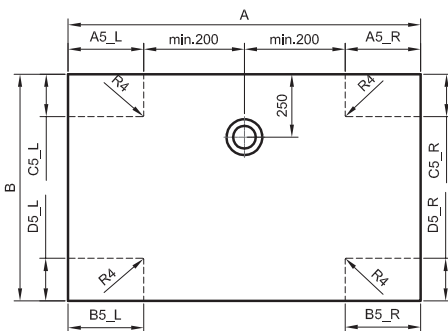

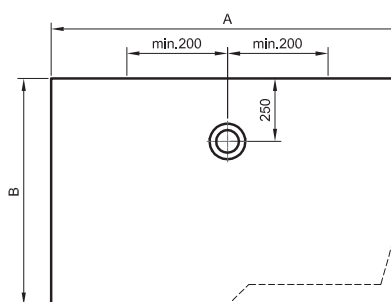

Option 5

	max. A/3
A5_L [mm]	
B5_L [mm]	
	max. A/3
A5_R [mm]	
B5_R [mm]	
	max. (B/2)-200mm
C5_L [mm]	
D5_L [mm]	
	max. B/3
C5_R [mm]	
D5_R [mm]	



Option 6

Special requirements
-< mark and quote
the cuts in the image

Tuš kadi Tuš kade		kolpa·san®		
Model	Naziv in dimenzija izdelka Naziv i dimenzije produkta	Opis Opis	EAN koda EAN koda	Cena EUR Cijena EUR
Dodatki za tuš kadi Dodaci za tuš kade				
	Sifon Ø 52 s pokrovom H=65 mm	Pretok: 52 l/min Protok: 52 l/min TRIN, DIXIE, ONTEX	3838987 512981	16,00
	Sifon Ø 52 brez pokrova H=65 mm	Pretok: 52 l/min Protok: 52 l/min STILETTO, DROP, LAVOLTA, RAMONA	3838987 563174	14,00
	Sifon Ø 90 s pokrovom H=65 mm	Pretok: 37 l/min Protok: 37 l/min FLAMENCO, CANARY, MALUR, MACARENA, REWALK, EVELIN	3838987 519904	26,00
	Sifon Ø 90 s pokrovom H=84 mm	Pretok: 43 l/min Protok: 43 l/min FLAMENCO, CANARY, MALUR, MACARENA, REWALK, EVELIN	3838987 925873	17,00
	Sifon Ø 90 brez pokrova H=65 mm	Pretok: 37 l/min Protok: 37 l/min BALLO, LIMBO, CAPO, SERRA, PANDORA, ACRO, MOONWALK	3838987 563181	19,00
	Sifon Ø 90 brez pokrova H=84 mm	Pretok: 43 l/min Protok: 43 l/min BALLO, LIMBO, ACRO, CAPO, PANDORA, SERRA, MOONWALK	3838987 927723	16,00
 9 x	Podnožje tuš kadi LM	Podnožje tuš kadi LM, (9 nogic) Podnožje za tuš kade LM, (9 nožica)	3838987 563150	37,00
 12 x	Podnožje tuš kadi RE-WALK	Podnožje tuš kadi RE-WALK, (12 nogic) Podnožje za tuš kade RE-WALK, (12 nožica)	3838987 563167	47,00
	Zidni montažni set Zidni montažni set	za kopalne in tuš kadi za vgradnjo za kupaonske i tuš kade za ugradnju	3838987 704362	12,00
	Suhomontažna zaključna letva Završna letva u sistemu suhe montaže	karton 25 kosov / karton 25 komada (Cena za kos / Cijena na komad 32,00 EUR)	3838987 903116	800,00
	ANTI-SLIP PREMAZ	protizdrsni premaz za tuš kadi protiv sklizni premaz za tuš kade (min. kol. 10 kos)		70,00
	Specialno čistilo KOLPA SAN Specialno sredstvo za čišćenje	krt = 20 x 0,5 l (Cena za kos / Cijena na komad 6,50 EUR)	3838987 747291	130,00
	Specialno čistilo ECO SAN Specijalno sredstvo	krt = 20 x 0,5 l (Cena za kos / Cijena na komad 5,70 EUR)	3838987 572220	114,00
	KERIL - Specialno čistilo za KERROCK KERIL - Specijalno sredstvo * tuš kad BALLO, TELLO, RAMONA TRAY, LEROCK ZERO, LAVOLTA	krt = 12 x 0,5 l (Cena za kos / Cijena na komad 4,50 EUR)	3838987 747307	54,00







Tuš kabine

Tuš kabine

POLARIS 150 POLARIS FOLD 153 ANDROMEDA 155 ATLAS 157

CALYPSO 160 LIBRA 162 VIRGO UNI 165 MONTES 166 DORSA UNI 168

PULSAR 169 SQ LINE 171 LUNA 176 ECO QUAT 178

Krilni zasloni za kopalne kadi

Paravani za kupaonske kade

POLARIS 180 ANDROMEDA 180 SOLE 181 QUAT 182

Re Wall - Kerrock stena

Re Wall - stijena od Kerrocka

RE-WALL 183

Q kvadratna / kvadratna (TKK)

R polkrožna / polukružna (TKP)

N niša / niša (TV/S)

D vrata / vrata (TV)

W stena / stijena (TSv)

DW vrata s steno / vrata sa stijenom

WO wall open / wall open (TS)

WIN walk in / walk in

BS krilni zaslon / paravan (TP)

STEKLA / STAKLA

1 kaljeno prozorno / kaljeno prozirno

2 chinchilla steklo / staklo

3 graphite steklo / graphite staklo

4 frost steklo / frost staklo

PROFILI / PROFILI

B black / black

SBR silver brill / silver brill

S silver / silver

WH white / white

Slike so simbolične. Pravilna rasporeditev elementov je v TEHNIČNEM KATALOGU na www.kolpasan.si

Slike su simbolične. Točan raspored elemenata je u TEHNIČKOM KATALOGU na www.kolpasan.hr

POSEBNE IZVEDBE tuš kabin, vrat, sten in zaslonov izven standardnih dimenzij:

- program DORSA, ATLAS, PULSAR, SQ-LINE, LUNA – 40% dražje od cene po ceniku
- program LIBRA, POLARIS, POLARIS FOLD, ANDROMEDA, CALYPSO – 20% dražje od cene po ceniku.
- program RE WALL – 10% dražje od cene po ceniku

Za večja odstopanja se izdelava posebna ponudba.

POSEBNE IZVEDBE tuš kabina, vrata, stranica i zasloni van standardnih dimenzija:

- program DORSA, ATLAS, PULSAR, SQ-LINE, LUNA - 40% skuplje od cijene navedene u cjeniku
- program LIBRA, POLARIS, POLARIS FOLD, ANDROMEDA, CALYPSO – 20% skuplje od cijene navedene u cjeniku
- program RE WALL – 10% skuplje od cijene navedene u cjeniku

Za veća odstupanja izrađuje se posebna ponuda.



Konfigurator
tuš kabin
posebnih
dimenzij

5







let garancije
godina jamstva





3

leta garancije
godina jamstva





SQ line in Eco Quat
SQ line i Eco Quat

















Tuš kabine Tuš kabine	Program: POLARIS Silver brill in black profili, H=200,		Silver brill in black profili. Kaljeno prozorno staklo(K), deblina stakla 8/6 mm, CLEAN COAT. Silver Brill i black profili. Kaljeno prozorno staklo(K), deblina stakla 8/6 mm, CLEAN COAT.	
Model	Naziv in dimenzija izdelka Naziv i dimenzije produkta	Opis Opis	EAN koda EAN koda	Cena EUR Cijena EUR
Q 100, 90, 80 SBR, B/1				
	Q 100 SBR/1	tuš kabina - kotna	3838987 515333	1.096,00
	Q 90 SBR/1	Silver brill tuš kabina - kutna	3838987 515326	1.045,00
	Q 80 SBR/1	CLEAN COAT premaz	3838987 515319	1.022,00
	Q 100 B/1	tuš kabina - kotna	3838987 515364	1.152,00
	Q 90 B/1	Black tuš kabina - kutna	3838987 515357	1.097,00
	Q 80 B/1	CLEAN COAT premaz	3838987 515340	1.072,00
R 100, 90 SBR, B/1				
	R 100 SBR/1	tuš kabina - polkrožna	3838987 515388	1.011,00
	R 90 SBR/1	Silver brill tuš kabina - polukružna	3838987 515371	980,00
	R 100 B/1	tuš kabina - polkrožna	3838987 515401	1.062,00
	R 90 B/1	Black tuš kabina - polukružna	3838987 515395	1.029,00
CLEAN COAT premaz				
N 140, 120 -L SBR, B/1				
	N 140 -L SBR/1	samostojna tuš vrata - leva	3838987 515937	723,00
	N 120 -L SBR/1	Silver brill samostoječa tuš vrata - lijeva	3838987 515913	664,00
	N 140 -L B/1	tuš kabina - polkrožna	3838987 516019	759,00
	N 120 -L B/1	Black samostoječa tuš vrata - lijeva	3838987 515999	697,00
CLEAN COAT premaz				
N 140, 120 -R SBR, B/1				
	N 140 -R SBR/1	samostojna tuš vrata - desna	3838987 515944	723,00
	N 120 -R SBR/1	Silver brill samostoječa tuš vrata - desna	3838987 515920	664,00
	N 140 -R B/1	tuš kabina - polkrožna	3838987 516088	759,00
	N 120 -R B/1	Black samostoječa tuš vrata - desna	3838987 516002	697,00
CLEAN COAT premaz				
N 100, 90 -L SBR, B/1				
	N 100 -L SBR/1	samostojna tuš vrata - leva	3838987 515890	639,00
	N 90 -L SBR/1	Silver brill samostoječa tuš vrata - lijeva	3838987 515876	618,00
	N 100 -L B/1	tuš kabina - polkrožna	3838987 515975	671,00
	N 90 -L B/1	Black samostoječa tuš vrata - lijeva	3838987 515951	649,00
CLEAN COAT premaz				

Tuš kabine Tuš kabine	Program: POLARIS Silver brill in black profili, H=200,		Silver brill in black profili. Kaljeno prozorno staklo(K), deblina stakla 8/6 mm, CLEAN COAT. Silver Brill i black profili. Kaljeno prozirno staklo(K), deblina stakla 8/6 mm, CLEAN COAT.	kolpa-san
Model	Naziv in dimenzija izdelka Naziv i dimenzije produkta	Opis Opis	EAN koda EAN koda	Cena EUR Cijena EUR
N 100, 90 -R SBR, B/1				
	N 100 -R SBR/1	samostojna tuš vrata - desna samostojeća tuš vrata - desna	3838987 515906	639,00
	N 90 -R SBR/1 Silver brill	CLEAN COAT premaz	3838987 515883	618,00
	N 100 -R B/1	samostojna tuš vrata - desna samostojeća tuš vrata - desna	3838987 515982	671,00
	N 90 -R B/1 Black	CLEAN COAT premaz	3838987 515968	649,00
D 140, 120, 100 -L SBR, B/1				
	D 140 -L SBR/1	tuš vrata - leva tuš vrata - lijeva	3838987 515692	696,00
	D 120 -L SBR/1 Silver brill	CLEAN COAT premaz	3838987 515678	668,00
	D 100 -L SBR/1		3838987 515456	623,00
	D 140 -L B/1	tuš vrata - leva tuš vrata - lijeva	3838987 515821	732,00
	D 120 -L B/1 Black	CLEAN COAT premaz	3838987 515807	701,00
	D 100 -L B/1		3838987 515784	654,00
D 140, 120, 100 -R SBR, B/1				
	D 140 -R SBR/1	tuš vrata - desna tuš vrata - desna	3838987 515708	696,00
	D 120 -R SBR/1 Silver brill	CLEAN COAT premaz	3838987 515685	668,00
	D 100 -R SBR/1		3838987 515463	623,00
	D 140 -R B/1	tuš vrata - desna tuš vrata - desna	3838987 515838	732,00
	D 120 -R B/1 Black	CLEAN COAT premaz	3838987 515814	701,00
	D 100 -R B/1		3838987 515791	654,00
D 90, 80 -L SBR, B/1				
	D 90 -L SBR/1	tuš vrata - leva tuš vrata - lijeva	3838987 515432	603,00
	D 80 -L SBR/1 Silver brill	CLEAN COAT premaz	3838987 515418	588,00
	D 90 -L B/1	tuš vrata - leva tuš vrata - lijeva	3838987 515760	632,00
	D 80 -L B/1 Black	CLEAN COAT premaz	3838987 515746	616,00
D 90, 80 -R SBR, B/1				
	D 90 -R SBR/1	tuš vrata - desna tuš vrata - desna	3838987 515449	603,00
	D 80 -R SBR/1 Silver brill	CLEAN COAT premaz	3838987 515425	588,00
	D 90 -R B/1	tuš vrata - desna tuš vrata - desna	3838987 515777	632,00
	D 80 -R B/1 Black	CLEAN COAT premaz	3838987 515753	616,00











Tuš kabine Tuš kabine	Program: POLARIS Silver brill in black profili, H=200,		Silver brill in black profili. Kaljeno prozorno steklo(K), deblina stekla 8/6 mm, CLEAN COAT. Silver Brill i black profili. Kaljeno prozorno staklo(K), debljina stakla 8/6 mm, CLEAN COAT.			
Model	Naziv in dimenzija izdelka Naziv i dimenzije produkta	Opis Opis	EAN koda EAN koda	Cena EUR Cijena EUR		
W 100, 90, 80 SBR, B/1						
	W 100 SBR/1	tuš stena (kombinacija z D)	3838987 515739	279,00		
	W 90 SBR/1	Silver brill	tuš stena (kombinacija s D)	3838987 515722	254,00	
	W 80 SBR/1		CLEAN COAT premaz	3838987 515715	234,00	
	W 100 B/1		debelina stekla/debljina stakla 8 mm	3838987 515869	293,00	
	W 90 B/1	Black	tuš stena (kombinacija s D)	3838987 515852	267,00	
	W 80 B/1		CLEAN COAT premaz	3838987 515845	245,00	
POS. DIM. Q, R, N, D, W SBR, B/1						
 	Q SBR/1	Posebne dimenzije	3838987 400110			
	R SBR/1	Posebne dimenzije	3838987 400134			
	N SBR/1	Silver brill	3838987 400196			
	D SBR/1		3838987 400158			
	W SBR/1		3838987 400165			
	Q B/1	Posebne dimenzije	3838987 400127			
	R B/1	Posebne dimenzije	3838987 400141			
	N B/1	Black	3838987 400202			
	D B/1		3838987 400172			
	W B/1		3838987 400189			







Dodatki / Dodaci POLARIS					
  	SDL	sedež za tuš kabino - višinsko nastavljiv	3838987 593935	247,00	
	STK-N	sjedalo za tuš kabino - podesiv po visini	3838987 573227	183,00	
	STK	sedež za tuš kabino z nogicama - preklopni sjedalo za tuš kabino sa nožicama - preklopni sedež za tuš kabino - preklopni sjedalo za tuš kabino - preklopni	3838987 950707	159,00	
	KS	kopalniški stolček, h=40 cm, prenosni kupaonska stolica, h=40 cm, prenosni	3838987 950608	59,00	
	Mast za ležaje in tečaje tuš kabin Mast za ležajeve i šarke tuš kabina	krt = 10 x 20 ml (Cena za kos / Cijena na komad 4,70 EUR)	3838987 994169	47,00	
	EL-16	Brisalec stekla Brisač stakla	3838987 402732	19,00	
	EL-17 (Krom)	obešalo za brisače, za na steklo tuš kabine	3838987 402107	17,00	
	EL-17B (Black)	vješalica za ručnike, za na staklo tuš kabine	3838987 402114	20,00	
	EL-09	dvojna viseća košarica za tuš kabino dvostruka viseća košarica za tuš kabinu	3838987 402664	136,00	
	Specialno čištilo KOLPA SAN Specialno sredstvo za čišćenje	krt = 20 x 0,5 l (Cena za kos / Cijena na komad 6,50 EUR)	3838987 747291	130,00	
	Specialno čištilo ECO SAN Specialno sredstvo za čišćenje	krt = 20 x 0,5 l (Cena za kos / Cijena na komad 5,70 EUR)	3838987 572220	114,00	

Tuš kabine Tuš kabine	Program: POLARIS FOLD Silver brill in black profili, H=200,		Silver brill in black profili. Kaljeno prozorno steklo(K), deblina stakla 6/6 mm, CLEAN COAT. Silver Brill i black profili. Kaljeno prozorno staklo(K), deblina stakla 6/6 mm, CLEAN COAT.	
Model	Naziv in dimenzija izdelka Naziv i dimenzije produkta	Opis Opis	EAN koda EAN koda	Cena EUR Cijena EUR
Q 100, 90, 80 SBR, B/1				
	Q 100 SBR/1	tuš kabina - kotna, zložljiva na notranjo ali zunanjo stran tuš kabina - kotna, zložljiva na unutarnju ili vansku stranu CLEAN COAT premaz	3838987 516118	1.253,00
	Q 90 SBR/1 Silver brill		3838987 516101	1.182,00
	Q 80 SBR/1		3838987 516095	1.140,00
	Q 100 B/1		3838987 516149	1.316,00
	Q 90 B/1 Black		3838987 516132	1.241,00
	Q 80 B/1		3838987 516125	1.198,00
N 100, 90, 80 -L SBR, B/1				
	N 100 -L SBR/1	samostojna tuš vrata - leva, zložljiva na notranjo ali zunanjo stran samostojeća tuš vrata - lijeva, zložljiva na unutarnju ili vansku stranu CLEAN COAT premaz	3838987 516378	690,00
	N 90 -L SBR/1 Silver brill		3838987 516354	654,00
	N 80 -L SBR/1		3838987 516330	641,00
	N 100 -L B/1		3838987 516439	725,00
	N 90 -L B/1 Black		3838987 516415	687,00
N 80 -L B/1	3838987 516392	673,00		
N 100, 90, 80 -R SBR, B/1				
	N 100 -R SBR/1	samostojna tuš vrata - desna, zložljiva na notranjo ali zunanjo stran samostojeća tuš vrata - desna, zložljiva na unutarnju ili vansku stranu CLEAN COAT premaz	3838987 516385	690,00
	N 90 -R SBR/1 Silver brill		3838987 516361	654,00
	N 80 -R SBR/1		3838987 516347	641,00
	N 100 -R B/1		3838987 516446	725,00
	N 90 -R B/1 Black		3838987 516422	687,00
N 80 -R B/1	3838987 516408	673,00		
D 100, 90, 80 -L SBR, B/1				
	D 100 -L SBR/1	tuš vrata - leva, zložljiva na notranjo ali zunanjo stran tuš vrata - lijeva, zložljiva na unutarnju ili vansku stranu CLEAN COAT premaz	3838987 516194	691,00
	D 90 -L SBR/1 Silver brill		3838987 516170	668,00
	D 80 -L SBR/1		3838987 516156	654,00
	D 100 -L B/1		3838987 516286	726,00
	D 90 -L B/1 Black		3838987 516262	701,00
	D 80 -L B/1		3838987 516248	687,00
D 100, 90, 80 -R SBR, B/1				
	D 100 -R SBR/1	tuš vrata - desna, zložljiva na notranjo ali zunanjo stran tuš vrata - desna, zložljiva na unutarnju ili vansku stranu CLEAN COAT premaz	3838987 516200	691,00
	D 90 -R SBR/1 Silver brill		3838987 516187	668,00
	D 80 -R SBR/1		3838987 516163	654,00
	D 100 -R B/1		3838987 516293	726,00
	D 90 -R B/1 Black		3838987 516279	701,00
	D 80 -R B/1		3838987 516255	687,00



Tuš kabine Tuš kabine		Program: POLARIS FOLD Silver brill in black profili, H=200,		Silver brill in black profili. Kaljeno prozorno steklo(K), debelina stekla 6/6 mm, CLEAN COAT. Silver Brill i black profili. Kaljeno prozorno staklo(K), debljina stakla 8/6 mm, CLEAN COAT.		kolpa-san	
Model	Naziv in dimenzija izdelka Naziv i dimenzije produkta	Opis Opis	EAN koda EAN koda	Cena EUR Cijena EUR			
W 100, 90, 80 SBR, B/1							
	W 100 SBR/1	Silver brill	tuš stena (kombinacija z D)	3838987 515739	279,00		
	W 90 SBR/1		tuš stena (kombinacija s D)	3838987 515722	254,00		
	W 80 SBR/1		CLEAN COAT premaz	3838987 515715	234,00		
	W 100 B/1	Black	tuš stena (kombinacija z D)	3838987 515869	293,00		
	W 90 B/1		tuš stena (kombinacija s D)	3838987 515852	267,00		
	W 80 B/1		CLEAN COAT premaz	3838987 515845	245,00		
POS. DIM. Q, N, D, W SBR, B/1							
	Q SBR/1	Silver brill	Posebne dimenzije	3838987 400219			
	N SBR/1		Posebne dimenzije	3838987 400257			
	D SBR/1			3838987 400233			
	W SBR/1			3838987 400165			
	Q B/1	Black	Posebne dimenzije	3838987 400226			
	N B/1		Posebne dimenzije	3838987 400264			
	D B/1			3838987 400240			
	W B/1			3838987 400189			

Dodatki / Dodaci POLARIS FOLD					
	SDL		sedež za tuš kabino - višinsko nastavljiv	3838987 593935	247,00
	STK-N		sjedalo za tuš kabino - podesiv po visini	3838987 573227	183,00
	STK		sedež za tuš kabino z nogicama - preklopni	3838987 950707	159,00
			sjedalo za tuš kabino sa nožicama - preklopni		
	KS		kopalniški stolček, h=40 cm, prenosni	3838987 950608	59,00
			kupaonska stolica, h=40 cm, prenosni		
	Mast za ležaje in tečaje tuš kabin		krt = 10 x 20 ml	3838987 994169	47,00
	Mast za ležajeve i šarke tuš kabina		(Cena za kos / Cijena na komad 4,70 EUR)		
	EL-16		Brisalec stekla	3838987 402732	19,00
			Brisač stakla		
	EL-17 (Krom)		obešalo za brisače, za na steklo tuš kabine	3838987 402107	17,00
	EL-17B (Black)		vješalica za ručnike, za na staklo tuš kabine	3838987 402114	20,00
	EL-09		dvojna viseća košarica za tuš kabino	3838987 402664	136,00
			dvostruka viseća košarica za tuš kabinu		
	Specialno čištilo KOLPA SAN		krt = 20 x 0,5 l	3838987 747291	130,00
	Specialno sredstvo za čišćenje		(Cena za kos / Cijena na komad 6,50 EUR)		
	Specialno čištilo ECO SAN		krt = 20 x 0,5 l	3838987 572220	114,00
	Specialno sredstvo za čišćenje		(Cena za kos / Cijena na komad 5,70 EUR)		

Tuš kabine Tuš kabine	Program: ANDROMEDA Silver brill in black profili, H=200,		Silver brill in black profili. Kaljeno prozorno steklo(K), deblina stekla 8/6 mm, CLEAN COAT. Silver Brill i black profili. Kaljeno prozorno staklo(K), debljina stakla 8/6 mm, CLEAN COAT.	
Model	Naziv in dimenzija izdelka Naziv i dimenzije produkta	Opis Opis	EAN koda EAN koda	Cena EUR Cijena EUR
Q 100, 90, 80 SBR, B/1				
	Q 100 SBR/1	tuš kabina - kotna	3838987 516477	827,00
	Q 90 SBR/1	Silver brill	3838987 516460	803,00
	Q 80 SBR/1	CLEAN COAT premaz	3838987 516453	779,00
	Q 100 B/1	tuš kabina - kotna	3838987 516507	868,00
	Q 90 B/1	Black	3838987 516491	844,00
	Q 80 B/1	CLEAN COAT premaz	3838987 516484	818,00
N 160, 140, 120 - UNI SBR, B/1				
	N 160 -UNI SBR/1	samostojna tuš vrata - univerzalna	3838987 516743	689,00
	N 140 -UNI SBR/1	Silver brill	3838987 516736	651,00
	N 120 -UNI SBR/1	samostojna tuš vrata - univerzalna	3838987 516729	620,00
	N 160 -UNI B/1	Black	3838987 516804	723,00
	N 140 -UNI B/1	samostojna tuš vrata - univerzalna	3838987 516798	684,00
	N 120 -UNI B/1	CLEAN COAT premaz	3838987 516781	651,00
N 100, 90, 80 - UNI SBR, B/1				
	N 100 -UNI SBR/1	samostojna tuš vrata - univerzalna	3838987 516712	492,00
	N 90 -UNI SBR/1	Silver brill	3838987 516705	466,00
	N 80 -UNI SBR/1	samostojna tuš vrata - univerzalna	3838987 516699	448,00
	N 100 -UNI B/1	Black	3838987 516774	517,00
	N 90 -UNI B/1	samostojna tuš vrata - univerzalna	3838987 516767	490,00
	N 80 -UNI B/1	CLEAN COAT premaz	3838987 516750	470,00
D 160, 140, 120 - UNI SBR, B/1				
	D 160 -UNI SBR/1	tuš vrata - univerzalna	3838987 516569	665,00
	D 140 -UNI SBR/1	Silver brill	3838987 516552	632,00
	D 120 -UNI SBR/1	tuš vrata - univerzalna	3838987 516545	603,00
	D 160 -UNI B/1	Black	3838987 516651	699,00
	D 140 -UNI B/1	tuš vrata - univerzalna	3838987 516644	664,00
	D 120 -UNI B/1	CLEAN COAT premaz	3838987 516637	632,00
D 100, 90, 80 - UNI SBR, B/1				
	D 100 -UNI SBR/1	tuš vrata - univerzalna	3838987 516538	511,00
	D 90 -UNI SBR/1	Silver brill	3838987 516521	485,00
	D 80 -UNI SBR/1	tuš vrata - univerzalna	3838987 516514	468,00
	D 100 -UNI B/1	Black	3838987 516620	537,00
	D 90 -UNI B/1	tuš vrata - univerzalna	3838987 516613	510,00
	D 80 -UNI B/1	CLEAN COAT premaz	3838987 516606	492,00

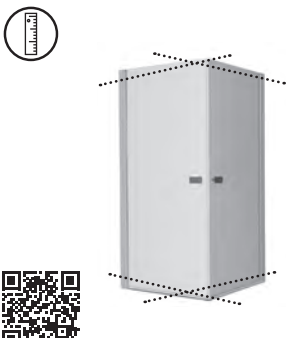

Tuš kabine Tuš kabine	Program: ANDROMEDA Silver brill in black profili, H=200,	Silver brill in black profili. Kaljeno prozorno steklo(K), deblina stakla 8/6 mm, CLEAN COAT. Silver Brill i black profili. Kaljeno prozorno staklo(K), debljina stakla 8/6 mm, CLEAN COAT.	kolpa-san	
Model	Naziv in dimenzija izdelka Naziv i dimenzije produkta	Opis Opis	EAN koda EAN koda	Cena EUR Cijena EUR
W 100, 90, 80 SBR, B/1				
	W 100 SBR/1	tuš stena (kombinacija z D) tuš stena (kombinacija s D)	3838987 515739	279,00
	W 90 SBR/1 Silver brill	CLEAN COAT premaz	3838987 515722	254,00
	W 80 SBR/1	debelina stakla/debljina stakla 8 mm	3838987 515715	234,00
	W 100 B/1	tuš stena (kombinacija z D) tuš stena (kombinacija s D)	3838987 515869	293,00
	W 90 B/1 Black	CLEAN COAT premaz	3838987 515852	267,00
	W 80 B/1	debelina stakla/debljina stakla 8 mm	3838987 515845	245,00
POS. DIM. Q, N, D, W SBR, B/1				
	Q SBR/1	Posebne dimenzije Posebne dimenzije	3838987 400271	
	N SBR/1		3838987 400318	
	D SBR/1 Silver brill		3838987 400295	
	W SBR/1		3838987 400165	
	Q B/1	Posebne dimenzije Posebne dimenzije	3838987 400288	
	N B/1		3838987 400325	
	D B/1 Black		3838987 400301	
	W B/1		3838987 400189	

Dodatki / Dodaci ANDROMEDA				
	SDL	sedež za tuš kabino - višinsko nastavljiv	3838987 593935	247,00
	STK-N	sjedalo za tuš kabino - podesiv po visini	3838987 573227	183,00
	STK	sedež za tuš kabino z nogicama - preklopni sedež za tuš kabino - preklopni	3838987 950707	159,00
	KS	kopalniški stolček, h=40 cm, prenosni kupaonska stolica, h=40 cm, prenosni	3838987 950608	59,00
	Mast za ležaje in tečaje tuš kabin Mast za ležajeve i šarke tuš kabina	krt = 10 x 20 ml (Cena za kos / Cijena na komad 4,70 EUR)	3838987 994169	47,00
	EL-16	Brisalec stakla Brisač stakla	3838987 402732	19,00
	EL-17 (Krom)	obešalo za brisače, za na steklo tuš kabine	3838987 402107	17,00
	EL-17B (Black)	vješalica za ručnike, za na staklo tuš kabine	3838987 402114	20,00
	EL-09	dvojna viseća košarica za tuš kabino dvostruka viseća košarica za tuš kabino	3838987 402664	136,00
	Specialno čistilo KOLPA SAN Specialno sredstvo za čišćenje	krt = 20 x 0,5 l (Cena za kos / Cijena na komad 6,50 EUR)	3838987 747291	130,00
	Specialno čistilo ECO SAN Specialno sredstvo za čišćenje	krt = 20 x 0,5 l (Cena za kos / Cijena na komad 5,70 EUR)	3838987 572220	114,00







Tuš kabine

Tuš kabine

Program: ATLAS Silver Brill profili, H=200





Silver Brill profili in kromirani dvizni tečajji. Kaljeno prozorno steklo(K), debelina stekla 6 mm. Silver Brill profili i kromirane podizne šarke. Kaljeno prozorno staklo(K), debljina stakla 6 mm.









kolpa-san

Model	Naziv in dimenzija izdelka Naziv i dimenzije produkta	Opis Opis	EAN koda EAN koda	Cena EUR Cijena EUR
TKK 100/K, 90/K				
	TKK 100/K	tuš kabina - kotna	3838987 560210	639,00
	TKK 90/K	tuš kabina - kutna	3838987 560203	576,00
	TKK 100/K-FROST	tuš kabina - kotna	3838987 560838	775,00
	TKK 90/K-FROST	tuš kabina - kutna FROST - neprosojni pas stekla neprozirni pojas stakla	3838987 560821	700,00
TKP 100/K, 90/K				
	TKP 100/K	tuš kabina - polkrožna	3838987 560234	647,00
	TKP 90/K	tuš kabina - polukružna	3838987 560227	581,00
	TKP 100/K-FROST	tuš kabina - polkrožna	3838987 560852	783,00
	TKP 90/K-FROST	tuš kabina - polukružna FROST - neprosojni pas stekla neprozirni pojas stakla	3838987 560845	702,00
TV/S 120/K-L				
	TV/S 120/K-L	samostojna tuš vrata - leva samostoječa tuš vrata - lijeva	3838987 560289	566,00
TV/S 100/K-L, 90/K-L				
	TV/S 100/K-L	samostojna tuš vrata - leva samostoječa tuš vrata - lijeva	3838987 560265	500,00
	TV/S 90/K-L		3838987 560241	492,00
TV/S 120/K-D				
	TV/S 120/K-D	samostojna tuš vrata - desna samostoječa tuš vrata - desna	3838987 560296	566,00
TV/S 100/K-D, 90/K-D				
	TV/S 100/K-D	samostojna tuš vrata - desna samostoječa tuš vrata - desna	3838987 560272	500,00
	TV/S 90/K-D		3838987 560258	492,00
www.kolpa.si		www.kolpa.hr		157

Tuš kabine
Tuš kabine



Tuš kabine Tuš kabine	Program: ATLAS Silver Brill profili, H=200		Silver Brill profili in kromirani dvižni tečajji. Kaljeno prozorno staklo(K), deblina stakla 6 mm. Silver Brill profili i kromirane podizne šarke. Kaljeno prozorno staklo(K), debljina stakla 6 mm. 	
Model	Naziv in dimenzija izdelka Naziv i dimenzije produkta	Opis Opis	EAN koda EAN koda	Cena EUR Cijena EUR
TV 120/K-L, 100/K-L, 90/K-L				
	TV 120/K-L TV 100/K-L TV 90/K-L	tuš vrata - leva (kombinacija s TSv) tuš vrata - lijeva (kombinacija s TSv)	3838987 560340 3838987 560326 3838987 560302	541,00 521,00 508,00
TV 120/K-D, 100/K-D, 90/K-D				
	TV 120/K-D TV 100/K-D TV 90/K-D	tuš vrata - desna (kombinacija s TSv) tuš vrata - desna (kombinacija s TSv)	3838987 560357 3838987 560333 3838987 560319	541,00 521,00 508,00
TSv 90K, 80/K				
	TSv 90/K TSv 80/K	tuš stena (kombinacija s TV) tuš stena (kombinacija s TV)	3838987 560371 3838987 560364	173,00 168,00
POS. DIM. TKK, TVS, TV, TSV-BRILL/K				
	TKK BRILL/K TVS BRILL/K TV BRILL/K TSV BRILL/K	Posebne dimenzije Posebne dimenzije	3838987 400431 3838987 400448 3838987 400455 3838987 400462	

Tuš kabine Tuš kabine	Program: ATLAS Silver Brill profili, H=200		Silver Brill profili in kromirani dvižni tečaji. Kaljeno prozorno steklo(K), debelina stekla 6 mm. Silver Brill profili i kromirane podizne šarke. Kaljeno prozorno staklo(K), debljina stakla 6 mm.	
Model	Naziv in dimenzija izdelka Naziv i dimenzije produkta	Opis Opis	EAN koda EAN koda	Cena EUR Cijena EUR
Dodatki / Dodaci ATLAS				
 <p>SDL</p> <p>STK-N</p>  <p>STK</p>	<p>SDL</p> <p>STK-N</p> <p>STK</p>	<p>sedež za tuš kabino - višinsko nastavljiv sjedalo za tuš kabino - podesiv po visini</p> <p>sedež za tuš kabino z nogicami - preklopni sjedalo za tuš kabino sa nožicama - preklopni</p> <p>sedež za tuš kabino - preklopni sjedalo za tuš kabino - preklopni</p>	<p>3838987 593935</p> <p>3838987 573227</p> <p>3838987 950707</p>	<p>247,00</p> <p>183,00</p> <p>159,00</p>
	<p>KS</p>	<p>kopalniški stolček, h=40 cm, prenosni kupaonska stolica, h=40 cm, prenosni</p>	<p>3838987 950608</p>	<p>59,00</p>
	<p>Mast za ležaje in tečaje tuš kabin Mast za ležajeve i šarke tuš kabina</p>	<p>krt = 10 x 20 ml (Cena za kos / Cijena na komad 4,70 EUR)</p>	<p>3838987 994169</p>	<p>47,00</p>
	<p>EL-16</p>	<p>Brisalec stekla Brisač stakla</p>	<p>3838987 402732</p>	<p>19,00</p>
	<p>EL-17 (Krom)</p> <p>EL-17B (Black)</p>	<p>obešalo za brisače, za na steklo tuš kabine vješalica za ručnike, za na staklo tuš kabine</p>	<p>3838987 402107</p> <p>3838987 402114</p>	<p>17,00</p> <p>20,00</p>
	<p>EL-09</p>	<p>dvojna viseča košarica za tuš kabino dvostruka viseća košarica za tuš kabinu</p>	<p>3838987 402664</p>	<p>136,00</p>
	<p>Specialno čistilo KOLPA SAN Specialno sredstvo za čišćenje</p> <p>Specialno čistilo ECO SAN Specialno sredstvo za čišćenje</p>	<p>krt = 20 x 0,5 l (Cena za kos / Cijena na komad 6,50 EUR)</p> <p>krt = 20 x 0,5 l (Cena za kos / Cijena na komad 5,70 EUR)</p>	<p>3838987 747291</p> <p>3838987 572220</p>	<p>130,00</p> <p>114,00</p>







Tuš kabine







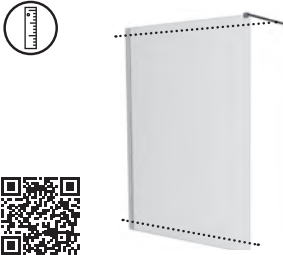

Tuš kabine

Program: CALYPSO Silver brill in black profili, H=200,







Silver brill in black profili. Kaljeno prozorno (/1) in GRAPHITE staklo (/3),
debelina stakla 8 mm, CLEAN COAT. Silver Brill i black profili. Kaljeno prozirno (/1)
i GRAPHITE staklo (/3), debljina stakla 8 mm, CLEAN COAT.





kolpa-san

Model	Naziv in dimenzija izdelka Naziv i dimenzije produkta	Opis Opis	EAN koda EAN koda	Cena EUR Cijena EUR
WO 140, 120, 100-UNI SBR, B/1				
	WO 140-UNI SBR/1	tuš stena - open tuš stijenka CLEAN COAT premaz Stabilizator d = max. 120 cm	3838987 517566	408,00
	WO 120-UNI SBR/1 Silver brill		3838987 517559	373,00
	WO 100-UNI SBR/1		3838987 517542	342,00
	WO 140-UNI B/1	Black	3838987 517603	429,00
	WO 120-UNI B/1		3838987 517597	392,00
	WO 100-UNI B/1		3838987 517580	359,00
WO 140, 120, 100-UNI SBR, B/3				
	WO 140-UNI SBR/3	tuš stena - GRAPHITE staklo tuš stijenka - GRAPHITE staklo CLEAN COAT premaz Stabilizator d = max. 120 cm	3838987 517832	439,00
	WO 120-UNI SBR/3 Silver brill		3838987 517825	395,00
	WO 100-UNI SBR/3		3838987 517818	358,00
	WO 140-UNI B/3	Black	3838987 517863	462,00
	WO 120-UNI B/3		3838987 517856	415,00
	WO 100-UNI B/3		3838987 517849	376,00
WIN 160-UNI SBR, B/1				
	WIN 160x100-UNI SBR/1	tuš kabina tuš kabina CLEAN COAT premaz	3838987 517665	596,00
	WIN 160x90-UNI SBR/1 Silver brill		3838987 517658	579,00
	WIN 160x80-UNI SBR/1		3838987 517641	564,00
	WIN 160x100-UNI B/1	Black	3838987 517726	627,00
	WIN 160x90-UNI B/1		3838987 517719	608,00
	WIN 160x80-UNI B/1		3838987 517702	592,00
WIN 140-UNI SBR, B/1				
	WIN 140x100-UNI SBR/1	tuš kabina tuš kabina CLEAN COAT premaz	3838987 517634	569,00
	WIN 140x90-UNI SBR/1 Silver brill		3838987 517627	550,00
	WIN 140x80-UNI SBR/1		3838987 517610	533,00
	WIN 140x100-UNI B/1	Black	3838987 517696	597,00
	WIN 140x90-UNI B/1		3838987 517689	579,00
	WIN 140x80-UNI B/1		3838987 517672	561,00
POS. DIM. WO, WIN SBR, B/1				
	WO SBR/1	Posebne dimenzije Posebne dimenzije	3838987 400332	
	WIN SBR/1		3838987 400356	
	WO B/1		3838987 400349	
	WIN B/1		3838987 400363	





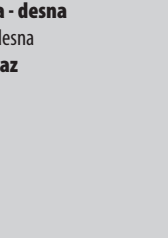
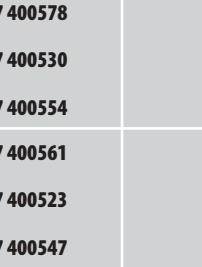

Tuš kabine Tuš kabine	Program: CALYPSO Silver brill in black profili, H=200,		Silver brill in black profili. Kaljeno prozorno (/1) in dimljeno steklo GRAPHITE (/3), debelina stakla 8 mm, CLEAN COAT. Silver Brill i black profili. Kaljeno prozorno (/1) i GRAPHITE dimljeno staklo (/3), debljina stakla 8 mm, CLEAN COAT.	
Model	Naziv in dimenzija izdelka Naziv i dimenzije produkta	Opis Opis	EAN koda EAN koda	Cena EUR Cijena EUR
Dodatki / Dodaci CALYPSO				
 <p>SDL</p> <p>STK-N</p>  <p>STK</p>	SDL STK-N STK	sedež za tuš kabino - višinsko nastavljiv sjedalo za tuš kabino - podesiv po visini sedež za tuš kabino z nogicama - preklopni sjedalo za tuš kabino sa nožicama - preklopni sedež za tuš kabino - preklopni sjedalo za tuš kabino - preklopni	3838987 593935 3838987 573227 3838987 950707	247,00 183,00 159,00
	KS	kopalniški stolček, h=40 cm, prenosni kupaonska stolica, h=40 cm, prenosni	3838987 950608	59,00
	Mast za ležaje in tečaje tuš kabin Mast za ležajeve i šarke tuš kabina	krt = 10 x 20 ml (Cena za kos / Cijena na komad 4,70 EUR)	3838987 994169	47,00
	EL-16	Brisalec stekla Brisač stakla	3838987 402732	19,00
	EL-17 (Krom) EL-17B (Black)	obežalo za brisače, za na steklo tuš kabine vješalica za ručnike, za na staklo tuš kabine	3838987 402107 3838987 402114	17,00 20,00
	EL-09	dvojna viseča košarica za tuš kabino dvostruka viseća košarica za tuš kabinu	3838987 402664	136,00
	Specialno čistilo KOLPA SAN Specialno sredstvo za čišćenje Specialno čistilo ECO SAN Specialno sredstvo za čišćenje	krt = 20 x 0,5 l (Cena za kos / Cijena na komad 6,50 EUR) krt = 20 x 0,5 l (Cena za kos / Cijena na komad 5,70 EUR)	3838987 747291 3838987 572220	130,00 114,00













Tuš kabine Tuš kabine	Program: LIBRA Silver brill in black profili, H=200,		Silver brill in black profili. Kaljeno prozorno steklo(1), deblina stekla 8/8 mm, CLEAN COAT. Silver Brill i black profili. Kaljeno prozorno staklo(1), debljina stakla 8/8 mm, CLEAN COAT.	
Model	Naziv in dimenzija izdelka Naziv i dimenzije produkta	Opis Opis	EAN koda EAN koda	Cena EUR Cijena EUR
Q 100, 90 SBR, B/1				
	Q 100 SBR/1	tuš kabina - kotna tuš kabina - kutna	3838987 516835	949,00
	Q 90 SBR/1 Silver brill	CLEAN COAT premaz	3838987 516828	914,00
	Q 100 B/1		3838987 516866	996,00
	Q 90 B/1 Black		3838987 516859	960,00
N 140, 120, 100 -L SBR, B/1				
	N 140 -L SBR/1	samostojna tuš vrata - leva samostojeća tuš vrata - lijeva	3838987 517450	599,00
	N 120 -L SBR/1 Silver brill	CLEAN COAT premaz	3838987 517436	566,00
	N 100 -L SBR/1		3838987 517412	524,00
	N 140 -L B/1		3838987 517511	629,00
	N 120 -L B/1 Black N 100 -L B/1		3838987 517498 3838987 517474	594,00 550,00
N 140, 120, 100 -R SBR, B/1				
	N 140 -R SBR/1	samostojna tuš vrata - desna samostojeća tuš vrata - desna	3838987 517467	599,00
	N 120 -R SBR/1 Silver brill	CLEAN COAT premaz	3838987 517443	566,00
	N 100 -R SBR/1		3838987 517429	524,00
	N 140 -R B/1		3838987 517528	629,00
	N 120 -R B/1 Black N 100 -R B/1		3838987 517504 3838987 517481	594,00 550,00
DW 140x90, 140x80 -L SBR, B/1				
	DW 140x90 -L SBR/1	tuš kabina, kotna - leva tuš kabina, kutna - lijeva	3838987 518396	762,00
	DW 140x80 -L SBR/1 Silver brill	CLEAN COAT premaz	3838987 516910	742,00
	DW 140x90 -L B/1		3838987 518495	800,00
	DW 140x80 -L B/1 Black		3838987 517375	779,00
DW 140x90, 140x80 -R SBR, B/1				
	DW 140x90 -R SBR/1	tuš kabina, kotna - desna tuš kabina, kutna - desna	3838987 518402	762,00
	DW 140x80 -R SBR/1 Silver brill	CLEAN COAT premaz	3838987 516927	742,00
	DW 140x90 -R B/1		3838987 518501	800,00
	DW 140x80 -R B/1 Black		3838987 517382	779,00





Tuš kabine Tuš kabine	Program: LIBRA Silver brill in black profili, H=200,		Silver brill in black profili. Kaljeno prozorno steklo(1), deblina stakla 8/8 mm, CLEAN COAT. Silver Brill i black profili. Kaljeno prozirno staklo(1), debljina stakla 8/8 mm, CLEAN COAT.		
Model	Naziv in dimenzija izdelka Naziv i dimenzije produkta	Opis Opis	EAN koda EAN koda	Cena EUR Cijena EUR	
DW 120x100, 120x90, 120x80 -L SBR, B/1					
	DW 120x100 -L SBR/1	tuš kabina, kotna - leva	3838987 517405	777,00	
	DW 120x90 -L SBR/1	Silver brill	3838987 517399	739,00	
	DW 120x80 -L SBR/1		CLEAN COAT premaz	3838987 516897	724,00
	DW 120x100 -L B/1			3838987 518464	816,00
	DW 120x90 -L B/1	Black		3838987 518457	776,00
	DW 120x80 -L B/1			3838987 517351	760,00
DW 120x100, 120x90, 120x80 -R SBR, B/1					
	DW 120x100 -R SBR/1	tuš kabina, kotna - desna	3838987 518389	777,00	
	DW 120x90 -R SBR/1	Silver brill	3838987 518372	739,00	
	DW 120x80 -R SBR/1		CLEAN COAT premaz	3838987 516903	724,00
	DW 120x100 -R B/1			3838987 518488	816,00
	DW 120x90 -R B/1	Black		3838987 518471	776,00
	DW 120x80 -R B/1			3838987 517368	760,00
DW 100x100, 100x90, 100x80 -L SBR, B/1					
	DW 100x100 -L SBR/1	tuš kabina, kotna - leva	3838987 516842	747,00	
	DW 100x90 -L SBR/1	Silver brill	3838987 516811	709,00	
	DW 100x80 -L SBR/1		CLEAN COAT premaz	3838987 516873	694,00
	DW 100x100 -L B/1			3838987 518426	784,00
	DW 100x90 -L B/1	Black		3838987 518419	744,00
	DW 100x80 -L B/1			3838987 516958	729,00
DW 100x100, 100x90, 100x80 -R SBR, B/1					
	DW 100x100 -R SBR/1	tuš kabina, kotna - desna	3838987 516941	747,00	
	DW 100x90 -R SBR/1	Silver brill	3838987 516934	709,00	
	DW 100x80 -R SBR/1		CLEAN COAT premaz	3838987 516880	694,00
	DW 100x100 -R B/1			3838987 518440	784,00
	DW 100x90 -R B/1	Black		3838987 518433	744,00
	DW 100x80 -R B/1			3838987 516965	729,00
POS. DIM. Q, N, DW SBR, B/1					
	Q SBR/1	Posebne dimenzije	3838987 400578		
	N SBR/1	Posebne dimenzije	3838987 400530		
	DW SBR/1		3838987 400554		
	Q B/1		3838987 400561		
	N B/1		3838987 400523		
	DW B/1		3838987 400547		









Tuš kabine Tuš kabine	Program: LIBRA Silver brill in black profili, H=200,		Silver brill in black profili. Kaljeno prozorno steklo(1), debelina stekla 8/8 mm, CLEAN COAT. Silver Brill i black profili. Kaljeno prozorno staklo(1), debljina stakla 8/8 mm, CLEAN COAT.	
Model	Naziv in dimenzija izdelka Naziv i dimenzije produkta	Opis Opis	EAN koda EAN koda	Cena EUR Cijena EUR
Dodatki / Dodaci LIBRA				
 <p>SDL</p> <p>STK-N</p>  <p>STK</p>	<p>SDL</p> <p>STK-N</p> <p>STK</p>	<p>sedež za tuš kabino - višinsko nastavljiv sjedalo za tuš kabino - podesiv po visini</p> <p>sedež za tuš kabino z nogicama - preklopni sjedalo za tuš kabino sa nožicama - preklopni</p> <p>sedež za tuš kabino - preklopni sjedalo za tuš kabino - preklopni</p>	<p>3838987 593935</p> <p>3838987 573227</p> <p>3838987 950707</p>	<p>247,00</p> <p>183,00</p> <p>159,00</p>
	<p>KS</p>	<p>kopalniški stolček, h=40 cm, prenosni kupaonska stolica, h=40 cm, prenosni</p>	<p>3838987 950608</p>	<p>59,00</p>
	<p>Mast za ležaje in tečaje tuš kabin Mast za ležajeve i šarke tuš kabina</p>	<p>krt = 10 x 20 ml (Cena za kos / Cijena na komad 4,70 EUR)</p>	<p>3838987 994169</p>	<p>47,00</p>
	<p>EL-16</p>	<p>Brisalec stekla Brisač stakla</p>	<p>3838987 402732</p>	<p>19,00</p>
	<p>Specialno čistilo KOLPA SAN Specialno sredstvo za čiščenje</p> <p>Specialno čistilo ECO SAN Specialno sredstvo za čiščenje</p>	<p>krt = 20 x 0,5 l (Cena za kos / Cijena na komad 6,50 EUR)</p> <p>krt = 20 x 0,5 l (Cena za kos / Cijena na komad 5,70 EUR)</p>	<p>3838987 747291</p> <p>3838987 572220</p>	<p>130,00</p> <p>114,00</p>











Tuš kabine Tuš kabine		Program: VIRGO UNI Silver Brill profili, H=200		Silver Brill profili. Kaljeno prozorno staklo(K), deblina stakla 8 mm, CLEAN COAT. / Silver Brill profili. Kaljeno prozirno staklo(K), debljina stakla 8 mm, CLEAN COAT.		kolpa-san	
Model	Naziv in dimenzija izdelka Naziv i dimenzije produkta	Opis Opis	EAN koda EAN koda	Cena EUR Cijena EUR			
TK 160x90/K, 160x80/K, 140x90/K, 140x80/K, 120x90/K, 120x80/K UNI							
	TK 160x90/K -UNI	tuš kabina, kotna tuš kabina, kutna	3838987 513223	731,00			
	TK 160x80/K -UNI		3838987 513193	720,00			
	TK 140x90/K -UNI	UNIVERZALNA CLEAN COAT premaz	3838987 513216	715,00			
	TK 140x80/K -UNI		3838987 513186	704,00			
	TK 120x90/K -UNI		3838987 513209	691,00			
	TK 120x80/K -UNI		3838987 513179	685,00			
TV2D/S 160/K, 140/K, 120/K UNI							
	TV2D/S 160/K -UNI	samostojna tuš vrata samostojeća tuš vrata	3838987 513162	625,00			
	TV2D/S 140/K -UNI		3838987 513155	607,00			
	TV2D/S 120/K -UNI	UNIVERZALNA CLEAN COAT premaz	3838987 513148	584,00			
		Program: VIRGO UNI BLACK profili, H=200		BLACK (črni) profili. Kaljeno prozorno staklo(K), deblina stakla 8 mm. BLACK (crni) profili. Kaljeno prozirno staklo(K), debljina stakla 8 mm.			
TK 120x90/K, 120x80/K UNI							
	TK 120x90/K BLACK -UNI	tuš kabina, kotna tuš kabina, kutna	3838987 513131	718,00			
	TK 120x80/K BLACK -UNI		3838987 512950	713,00			
UNIVERZALNA CLEAN COAT premaz							
Dodatki / Dodaci VIRGO							
	SDL	sedež za tuš kabino - višinsko nastavljiv	3838987 593935	247,00			
	STK-N	sjedalo za tuš kabino - podešiv po visini	3838987 573227	183,00			
	STK	sedež za tuš kabino z nogicama - preklopni sjedalo za tuš kabino sa nožicama - preklopni sedež za tuš kabino - preklopni sjedalo za tuš kabino - preklopni	3838987 950707	159,00			
	KS	kopalniški stolček, h=40 cm, prenosni kupaonska stolica, h=40 cm, prenosni	3838987 950608	59,00			
	Mast za ležaje in tečaje tuš kabin Mast za ležajeve i šarke tuš kabina	krt = 10 x 20 ml (Cena za kos / Cijena na komad 4,70 EUR)	3838987 994169	47,00			
	EL-16	Brisalec stakla Brisač stakla	3838987 402732	19,00			
	EL-17 (Krom)	obešalo za brisače, za na staklo tuš kabine	3838987 402107	17,00			
	EL-17B (Black)		3838987 402114	20,00			
	EL-09	dvojna viseća košarica za tuš kabino dvostruka viseća košarica za tuš kabinu	3838987 402664	136,00			
	Specialno čistilo KOLPA SAN Specialno sredstvo za čišćenje	krt = 20 x 0,5 l (Cena za kos / Cijena na komad 6,50 EUR)	3838987 747291	130,00			
	Specialno čistilo ECO SAN Specialno sredstvo za čišćenje	krt = 20 x 0,5 l (Cena za kos / Cijena na komad 5,70 EUR)	3838987 572220	114,00			
www.kolpa.si		www.kolpa.hr		165			









Tuš kabine Tuš kabine	Program: MONTES Silver Brill profili, H=200		Silver Brill profili. Kaljeno prozorno staklo(K), deblina stakla 8 mm, CLEAN COAT. / Silver Brill profili. Kaljeno prozorno staklo(K), deblina stakla 8 mm, CLEAN COAT. 	
Model	Naziv in dimenzija izdelka Naziv i dimenzije produkta	Opis Opis	EAN koda EAN koda	Cena EUR Cijena EUR
TK 140x90/K, 140x80/K, 120x90/K, 120x80/K-L CL. C				
	TK 140x90/K-L TK 140x80/K-L TK 120x90/K-L TK 120x80/K-L	tuš kabina, kotna - leva tuš kabina, kutna - lijeva CLEAN COAT premaz	3838987514411 3838987 514398 3838987 514374 3838987 514435	751,00 737,00 708,00 696,00
TK 140x90/K, 140x80/K, 120x90/K, 120x80/K-D CL. C				
	TK 140x90/K-D TK 140x80/K-D TK 120x90/K-D TK 120x80/K-D	tuš kabina, kotna - desna tuš kabina, kutna - desna CLEAN COAT premaz	3838987 514404 3838987 514381 3838987 512912 3838987 514428	751,00 737,00 708,00 696,00
TV2D/S 140/K, 120/K-L CL. C				
	TV2D/S 140/K-L TV2D/S 120/K-L	samostojna tuš vrata - leva samostojeća tuš vrata - leva CLEAN COAT premaz	3838987 514473 3838987 514459	639,00 604,00
TV2D/S 140/K, 120/K-D CL. C				
	TV2D/S 140/K-D TV2D/S 120/K-D	samostojna tuš vrata - desna samostojeća tuš vrata - desna CLEAN COAT premaz	3838987 514466 3838987 514442	639,00 604,00

Tuš kabine Tuš kabine	Program: MONTES Silver Brill profili, H=200		Silver Brill profili. Kaljeno prozorno staklo(K), debelina stakla 8 mm. Silver Brill profili. Kaljeno prozorno staklo(K),debljina stakla 8 mm.	
Model	Naziv in dimenzija izdelka Naziv i dimenzije produkta	Opis Opis	EAN koda EAN koda	Cena EUR Cijena EUR
Dodatki / Dodaci MONTES				
 <p>SDL</p> <p>STK-N</p>  <p>STK</p>	<p>SDL</p> <p>STK-N</p> <p>STK</p>	<p>sedež za tuš kabino - višinsko nastavljiv sjedalo za tuš kabino - podesiv po visini</p> <p>sedež za tuš kabino z nogicama - preklopni sjedalo za tuš kabino sa nožicama - preklopni</p> <p>sedež za tuš kabino - preklopni sjedalo za tuš kabino - preklopni</p>	<p>3838987 593935</p> <p>3838987 573227</p> <p>3838987 950707</p>	<p>247,00</p> <p>183,00</p> <p>159,00</p>
	<p>KS</p>	<p>kopalniški stolček, h=40 cm, prenosni kupaonska stolica, h=40 cm, prenosni</p>	<p>3838987 950608</p>	<p>59,00</p>
	<p>Mast za ležaje in tečaje tuš kabin Mast za ležajeve i šarke tuš kabina</p>	<p>krt = 10 x 20 ml (Cena za kos / Cijena na komad 4,70 EUR)</p>	<p>3838987 994169</p>	<p>47,00</p>
	<p>EL-16</p>	<p>Brisalec stakla Brisač stakla</p>	<p>3838987 402732</p>	<p>19,00</p>
	<p>Specialno čistilo KOLPA SAN Specialno sredstvo za čiščenje</p> <p>Specialno čistilo ECO SAN Specialno sredstvo za čiščenje</p>	<p>krt = 20 x 0,5 l (Cena za kos / Cijena na komad 6,50 EUR)</p> <p>krt = 20 x 0,5 l (Cena za kos / Cijena na komad 5,70 EUR)</p>	<p>3838987 747291</p> <p>3838987 572220</p>	<p>130,00</p> <p>114,00</p>



Tuš kabine Tuš kabine		Program: DORSA UNI Silver Brill profili, H=200		Silver Brill profili. Kaljeno prozorno staklo(K), deblina stakla 8 mm, CLEAN COAT. / Silver Brill profili. Kaljeno prozirno staklo(K), deblina stakla 8 mm, CLEAN COAT.		kolpa-san	
Model	Naziv in dimenzija izdelka Naziv i dimenzije produkta	Opis Opis	EAN koda EAN koda			Cena EUR Cijena EUR	
TK 140x90/K, 140x80/K, 120x90/K, 120x80/K UNI	Vgradna mera / Ugradna mijera						
	TK 140x90/K -UNI 137-144	tuš kabina, kotna	3838987 514008			672,00	
	TK 140x80/K -UNI 137-144	tuš kabina, kutna	3838987 513995			663,00	
	TK 120x90/K -UNI 117-124	UNIVERZALNA	3838987 513988			647,00	
	TK 120x80/K -UNI 117-124	CLEAN COAT premaz	3838987 513971			635,00	
TV2D/S 140/K, 120/K UNI	Vgradna mera / Ugradna mijera						
	TV2D/S 140/K -UNI 137-145	samostojna tuš vrata	3838987 513964			545,00	
	TV2D/S 120/K -UNI 117-125	samostojeća tuš vrata	3838987 513957			534,00	
		UNIVERZALNA					
		CLEAN COAT premaz					
POS. DIM. TK, TV2D/S BRILL /K							
 	TK BRILL /K	Posebne dimenzije	3838987 400509				
	TV2D/S BRILL/K	Posebne dimenzije	3838987 400516				
Dodatki / Dodaci DORSA							
	SDL	sedež za tuš kabino - višinsko nastavljiv	3838987 593935			247,00	
	STK-N	sjedalo za tuš kabino - podesiv po visini	3838987 573227			183,00	
	STK	sedež za tuš kabino z nogicama - preklopni	3838987 950707			159,00	
		sjedalo za tuš kabino sa nožicama - preklopni					
	KS	kopalniški stolček, h=40 cm, prenosni	3838987 950608			59,00	
		kupaonska stolica, h=40 cm, prenosni					
	Mast za ležaje in tečaje tuš kabin	krt = 10 x 20 ml	3838987 994169			47,00	
	Mast za ležajeve i šarke tuš kabina	(Cena za kos / Cijena na komad 4,70 EUR)					
	EL-16	Brisalec stakla	3838987 402732			19,00	
		Brisač stakla					
	EL-17 (Krom)	obešalo za brisače, za na staklo tuš kabine	3838987 402107			17,00	
	EL-17B (Black)	vješalica za ručnike, za na staklo tuš kabine	3838987 402114			20,00	
	EL-09	dvojna viseća košarica za tuš kabino	3838987 402664			136,00	
		dvostruka viseća košarica za tuš kabinu					
	Specialno čistilo KOLPA SAN	krt = 20 x 0,5 l	3838987 747291			130,00	
	Specialno sredstvo za čišćenje	(Cena za kos / Cijena na komad 6,50 EUR)					
	Specialno čistilo ECO SAN	krt = 20 x 0,5 l	3838987 572220			114,00	
	Specialno sredstvo za čišćenje	(Cena za kos / Cijena na komad 5,70 EUR)					
168	www.kolpa.hr	www.kolpa.si					

Tuš kabine Tuš kabine	Program: PULSAR Silver profili, H=200		Silver profili. Kaljeno prozorno staklo(K), debelina stakla 6 mm. Silver profili. Kaljeno prozorno staklo(K), debljina stakla 6 mm.	
Model	Naziv in dimenzija izdelka Naziv i dimenzije produkta	Opis Opis	EAN koda EAN koda	Cena EUR Cijena EUR
TKK/K 100, 90	SNEMLJIVI VRATNI KRILI ODVOJIVA VRATNA KRILA			
	TKK 100/K TKK 90/K	tuš kabina - kotna tuš kabina - kutna	3838987 560159 3838987 560166	474,00 457,00
TKP/K 100, 90	SNEMLJIVI VRATNI KRILI ODVOJIVA VRATNA KRILA			
	TKP 100/K TKP 90/K	tuš kabina - polkrožna tuš kabina - polukružna	3838987 560418 3838987 560388	480,00 461,00
TV2D/S 120/K, 100/K-L	SNEMLJIVI VRATNI KRILI ODVOJIVA VRATNA KRILA			
	TV2D/S 120/K-L TV2D/S 100/K-L	samostojna tuš vrata (možna kombinacija s TS) - leva samostoječa tuš vrata (možna kombinacija s TS) - lijeva	3838987 513018 3838987 512998	383,00 362,00
TV2D/S 120/K, 100/K-D	SNEMLJIVI VRATNI KRILI ODVOJIVA VRATNA KRILA			
	TV2D/S 120/K-D TV2D/S 100/K-D	samostojna tuš vrata (možna kombinacija s TS) - desna samostoječa tuš vrata (možna kombinacija s TS) - desna	3838987 513025 3838987 513001	383,00 362,00
TS 90/K, 80/K				
	TS 90/K TS 80/K	tuš stena tuš stijena (kombinacija s TKK, TKP, TV/2D)	3838987 513049 3838987 513032	160,00 150,00



Tuš kabine Tuš kabine	Program: PULSAR Silver profili, H=200		Silver profili. Kaljeno prozorno steklo(K), debljina stakla 6 mm. Silver profili. Kaljeno prozorno staklo(K), debljina stakla 6 mm.	kolpa-san
Model	Naziv in dimenzija izdelka Naziv i dimenzije produkta	Opis Opis	EAN koda EAN koda	Cena EUR Cijena EUR
POS. DIM. TKK, TKP, TV2D/S, TS, /K				
	TKK /K SILVER	Posebne dimenzije Posebne dimenzije	3838987 301813	
	TKP /K SILVER		3838987 400479	
	TV2D/S /K SILVER		3838987 400486	
	TS /K SILVER		3838987 400493	

Dodatki / Dodaci PULSAR				
	K-25 Profil	kompensacijski profil za TKK, TKP, TV in TS / kompensacijski profil za TKK, TKP, TV i TS	3838987 513056	46,00

Dodatki / Dodaci PULSAR				
	SDL	sedež za tuš kabino - višinsko nastavljiv	3838987 593935	247,00
	STK-N	sjedalo za tuš kabino - podesiv po visini	3838987 573227	183,00
	STK	sedež za tuš kabino z nogicama - preklopni	3838987 950707	159,00
	KS	sejalo za tuš kabino - preklopni		
	KS	kopalniški stolček, h=40 cm, prenosni	3838987 950608	59,00
		kupaonska stolica, h=40 cm, prenosni		
	Mast za ležaje in tečaje tuš kabin	krt = 10 x 20 ml	3838987 994169	47,00
	Mast za ležajeve i šarke tuš kabina	(Cena za kos / Cijena na komad 4,70 EUR)		
	EL-16	brisač stakla	3838987 402732	19,00
		Brisač stakla		
	EL-09	dvojnica viseća košarica za tuš kabino	3838987 402664	136,00
		dvostruka viseća košarica za tuš kabinu		
	Specialno čistilo KOLPA SAN	krt = 20 x 0,5 l	3838987 747291	130,00
	Specialno sredstvo za čišćenje	(Cena za kos / Cijena na komad 6,50 EUR)		
	Specialno čistilo ECO SAN	krt = 20 x 0,5 l	3838987 572220	114,00
	Specialno sredstvo za čišćenje	(Cena za kos / Cijena na komad 5,70 EUR)		





Tuš kabine

Tuš kabine

Program: SQ line Silver profili, H=190

Silver profili. Kaljeno prozorno (K) in kaljeno chinchilla steklo (CH), debelina stekla 5/6 mm. Silver profili. Kaljeno prozorno (K) i kaljeno chinchilla staklo (CH), debljina stakla 5/6 mm.

kolpa-san

Model	Naziv in dimenzija izdelka Naziv i dimenzije produkta	Opis Opis	EAN koda EAN koda	Cena EUR Cijena EUR
TKK /K, CH 120, 100, 90, 80, 75, 70	SNEMLJIVI VRATNI KRILI ODVOJIVA VRATNA KRILA			
	TKK 120x90 /K	tuš kabina - kotna	3838987 513322	455,00
	TKK 120x80 /K	tuš kabina - kutna	3838987 513315	445,00
	TKK 100 /K		3838987 511205	414,00
	TKK 100 /CH		3838987 511182	434,00
	TKK 100x90 /K		3838987 511403	406,00
	TKK 100x90 /CH		3838987 511380	428,00
	TKK 90 /K		3838987 511045	300,00
	TKK 90 /CH		3838987 511021	316,00
	TKK 100x80 /K		3838987 511328	399,00
	TKK 100x80 /CH		3838987 511304	418,00
	TKK 90x80 /K		3838987 511366	389,00
	TKK 90x80 /CH		3838987 511342	406,00
	TKK 80 /K		3838987 511007	292,00
	TKK 80 /CH		3838987 510987	307,00
TKK 90x75 /K		3838987 511274	389,00	
TKK 90x75 /CH		3838987 511281	406,00	
TKK 90x70 /K		3838987 511243	384,00	
TKK 90x70 /CH		3838987 511229	403,00	
TKK 70 /K		3838987 512660	381,00	
TKK 70 /CH		3838987 512653	399,00	
TKP /K, CH R 550 120, 100, 90, 80	SNEMLJIVI VRATNI KRILI ODVOJIVA VRATNA KRILA			
	TKP 120x90 /K R550	tuš kabina - polkrožna, asimetrična	3838987 511540	484,00
	TKP 120x90 /CH R550	tuš kabina - polukružna, asimetrična	3838987 511526	507,00
	TKP 100 /K R550	tuš kabina - polkrožna	3838987 511441	455,00
	TKP 100 /CH R550	tuš kabina - polukružna	3838987 511427	477,00
	TKP 100x80 /K R550	tuš kabina - polkrožna, asimetrična	3838987 511489	452,00
	TKP 100x80 /CH R550	tuš kabina - polukružna, asimetrična	3838987 511465	473,00
	TKP 90 /K R550	tuš kabina - polkrožna	3838987 511120	303,00
	TKP 90 /CH R550	tuš kabina - polukružna	3838987 511106	320,00
TKP 80 /K R550		3838987 511083	292,00	
TKP 80 /CH R550		3838987 511069	307,00	
TV2D/S K, CH 130, 120, 110, 100	SNEMLJIVI VRATNI KRILI ODVOJIVA VRATNA KRILA			
	TV2D/S 130 /K	samostojna tuš vrata, dvodelna (možna kombinacija s TS)	3838987 511700	359,00
	TV2D/S 130 /CH	samostoječa tuš vrata, dvodjelna	3838987 511687	377,00
	TV2D/S 120 /K	(moguća kombinacija s TS)	3838987 511663	348,00
	TV2D/S 120 /CH		3838987 511649	364,00
	TV2D/S 110 /K		3838987 511625	334,00
	TV2D/S 110 /CH		3838987 511601	353,00
	TV2D/S 100 /K		3838987 511588	322,00
	TV2D/S 100 /CH		3838987 511564	337,00
TV4D/S K, CH 170, 160, 140	SNEMLJIVI VRATNI KRILI ODVOJIVA VRATNA KRILA			
	TV4D/S 170 /K	samostojna tuš vrata, štiridelna (možna kombinacija s TS)	3838987 511823	457,00
	TV4D/S 170 /CH	samostoječa tuš vrata, četiridjelna	3838987 511809	478,00
	TV4D/S 160 /K	(moguća kombinacija s TS)	3838987 511786	445,00
	TV4D/S 160 /CH		3838987 511762	468,00
	TV4D/S 140 /K		3838987 511748	428,00
	TV4D/S 140 /CH		3838987 511724	449,00
	www.kolpa.si	www.kolpa.hr		171



Tuš kabine Tuš kabine	Program: SQ line Silver profili, H=190	Silver profili. Kaljeno prozorno (K) in kaljeno chinchilla steklo (CH), debelina stekla 5 mm. Silver profili. Kaljeno prozirno (K) i kaljeno chinchilla staklo (CH), debljina stakla 5 mm.		kolpa-san
Model	Naziv in dimenzija izdelka Naziv i dimenzije produkta	Opis Opis	EAN koda EAN koda	Cena EUR Cijena EUR
TS /K, CH 90, 80, 75, 70				
	TS 90/K	tuš stena (kombinacija s TKK, TKP, TV/2D, TV/4D)	3838987 527688	211,00
	TS 90/CH		3838987 527664	219,00
	TS 80/K	tuš stijena (kombinacija s TKK, TKP, TV/2D, TV/4D)	3838987 527640	194,00
	TS 80/CH		3838987 527626	207,00
	TS 75/K		3838987 527602	191,00
	TS 75/CH		3838987 527589	203,00
	TS 70/K		3838987 527565	189,00
TS 70/CH		3838987 527541	201,00	
Dodatki / Dodaci SQ line				
	K-30 SILVER	kompensacijski profil za TKK, TKP, TV in TS SQ line / kompenzacijski profil za TKK, TKP, TV in TS SQ line	3838987 527442	46,00

	Program: SQ line Silver profili, H=160	Silver profili, H=160. Kaljeno chinchilla steklo (CH), debelina stekla 5/6 mm. Silver profili, H=160. Kaljeno chinchilla staklo (CH), debljina stakla 5/6 mm.		kolpa-san
TKP 90 /CH DIXIE	SNEMLJIVI VRATNI KRILI ODVOJIVA VRATNA KRILA			
	TKP 90 /CH DIXIE R550	tuš kabina - polkrožna, za tuš kad Dixie, h=160 tuš kabina - polukružna, za tuš kadu Dixie, h=160	3838987 511502	414,00

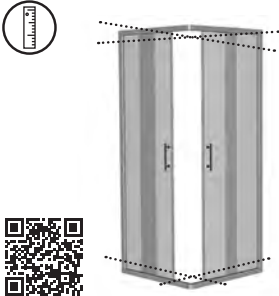
POS. DIM. TKK, TKP, TV2D/S, TV4D/S				
	TKK/K SILVER	Posebne dimenzije	3838987 512783	
	TKP/K SILVER	Posebne dimenzije	3838987 512752	
	TV2D/S/K SILVER		3838987 512790	
	TV4D/S/K SILVER		3838987 512813	
	TS/K SILVER		3838987 316749	





Tuš kabine

Tuš kabine

Program: SQ line Beli profili, H=190

Beli profili. Kaljeno prozorno (K) in kaljeno chinchilla steklo (CH), debelina stekla 5/6 mm. Bijeli profili. Kaljeno prozorno (K) i kaljeno chinchilla staklo (CH), debljina stakla 5/6 mm.

kolpa-san

Model	Naziv in dimenzija izdelka Naziv i dimenzije produkta	Opis Opis	EAN koda EAN koda	Cena EUR Cijena EUR
TKK /K, CH 120, 100, 90, 80, 75, 70	SNEMLJIVI VRATNI KRILI ODVOJIVA VRATNA KRILA			
	TKK 120x90 /K	tuš kabina - kotna	3838987 513346	393,00
	TKK 120x80 /K	tuš kabina - kutna	3838987 513339	383,00
	TKK 100 /K		3838987 511199	365,00
	TKK 100 /CH		3838987 511175	383,00
	TKK 100x90 /K		3838987 511397	359,00
	TKK 100x90 /CH		3838987 511373	378,00
	TKK 90 /K		3838987 511038	292,00
	TKK 90 /CH		3838987 511014	307,00
	TKK 100x80 /K		3838987 511311	354,00
	TKK 100x80 /CH		3838987 511298	370,00
	TKK 90x80 /K		3838987 511359	344,00
	TKK 90x80 /CH		3838987 511335	360,00
	TKK 80 /K		3838987 510994	281,00
	TKK 80 /CH		3838987 510970	297,00
TKK 90x75 /K		3838987 511250	344,00	
TKK 90x75 /CH		3838987 511267	360,00	
TKK 90x70 /K		3838987 511236	341,00	
TKK 90x70 /CH		3838987 511212	358,00	
TKP /K, CH R 550 120, 100, 90, 80	SNEMLJIVI VRATNI KRILI ODVOJIVA VRATNA KRILA			
	TKP 120x90 /K R550	tuš kabina - polkrožna, asimetrična	3838987 511533	402,00
	TKP 120x90 /CH R550	tuš kabina - polukružna, asimetrična	3838987 511519	422,00
	TKP 100 /K R550	tuš kabina - polkrožna	3838987 511434	380,00
	TKP 100 /CH R550	tuš kabina - polukružna	3838987 511410	397,00
	TKP 100x80 /K R550	tuš kabina - polkrožna, asimetrična	3838987 511472	377,00
	TKP 100x80 /CH R550	tuš kabina - polukružna, asimetrična	3838987 511458	395,00
	TKP 90 /K R550	tuš kabina - polkrožna	3838987 511113	296,00
	TKP 90 /CH R550	tuš kabina - polukružna	3838987 511090	313,00
TKP 80 /K R550		3838987 511076	281,00	
TKP 80 /CH R550		3838987 511052	297,00	
TV2D/S K, CH 130, 120, 110, 100	SNEMLJIVI VRATNI KRILI ODVOJIVA VRATNA KRILA			
	TV2D/S 130 /K	samostojna tuš vrata, dvodelna (možna kombinacija s TS)	3838987 511694	327,00
	TV2D/S 130 /CH	samostoječa tuš vrata, dvodjelna	3838987 511670	342,00
	TV2D/S 120 /K	(moguća kombinacija s TS)	3838987 511656	318,00
	TV2D/S 120 /CH		3838987 511632	331,00
	TV2D/S 110 /K		3838987 511618	309,00
	TV2D/S 110 /CH		3838987 511595	322,00
	TV2D/S 100 /K		3838987 511571	296,00
	TV2D/S 100 /CH		3838987 511557	310,00
TV4D/S K, CH 170, 160, 140	SNEMLJIVI VRATNI KRILI ODVOJIVA VRATNA KRILA			
	TV4D/S 170 /K	samostojna tuš vrata, štiridelna (možna kombinacija s TS)	3838987 511816	415,00
	TV4D/S 170 /CH	samostoječa tuš vrata, četiridjelna	3838987 511793	437,00
	TV4D/S 160 /K	(moguća kombinacija s TS)	3838987 511779	403,00
	TV4D/S 160 /CH		3838987 511755	424,00
	TV4D/S 140 /K		3838987 511731	392,00
	TV4D/S 140 /CH		3838987 511717	408,00





Tuš kabine
Tuš kabine



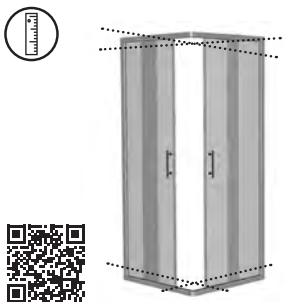

Tuš kabine Tuš kabine	Program: SQ line Beli profili, H=190		Beli profili. Kaljeno prozorno (K) in kaljeno chinchilla steklo (CH), debelina stekla 5 mm. Bijeli profili. Kaljeno prozirno (K) i kaljeno chinchilla staklo (CH), debljina stakla 5 mm.		kolpa-san
Model	Naziv in dimenzija izdelka Naziv i dimenzije produkta	Opis Opis	EAN koda EAN koda	Cena EUR Cijena EUR	
TS /K, CH 90, 80, 75, 70					
	TS 90/K	tuš stena (kombinacija s TKK, TKP, TV/2D, TV/4D) tuš stijena (kombinacija s TKK, TKP, TV/2D, TV/4D)	3838987 527671	176,00	
	TS 90/CH		3838987 527657	185,00	
	TS 80/K		3838987 527633	165,00	
	TS 80/CH		3838987 527619	173,00	
	TS 75/K		3838987 527596	158,00	
	TS 75/CH		3838987 527572	169,00	
	TS 70/K		3838987 527558	156,00	
TS 70/CH		3838987 527534	168,00		
Dodatki / Dodaci SQ line					
	K-30 BELI	kompensacijski profil za TKK, TKP, TV in TS SQ line / kompensacijski profil za TKK, TKP, TV in TS SQ line	3838987 527435	39,00	



Tuš kabine Tuš kabine	Program: SQ line Beli profili, H=160		Beli profili. Kaljeno chinchilla steklo (CH), debelina stekla 5/6 mm. Bijeli profili. Kaljeno chinchilla staklo (CH), debljina stakla 5/6 mm.		kolpa-san
Model	Naziv in dimenzija izdelka Naziv i dimenzije produkta	Opis Opis	EAN koda EAN koda	Cena EUR Cijena EUR	
TKP 90 /CH DIXIE	SNEMLJIVI VRATNI KRILI ODVOJIVA VRATNA KRILA				
	TKP 90 /CH DIXIE R550	tuš kabina - polkrožna, za tuš kad Dixie, h=160 tuš kabina - polukružna, za tuš kadu Dixie, h=160	3838987 511496	347,00	

POS. DIM. TKK, TKP, TV2D/S, TV4D/S					
	TKK/K BELA	Posebne dimenzije Posebne dimenzije	3838987 512776		
	TKP/K BELA		3838987 512745		
	TV2D/S/K BELA		3838987 512806		
	TV4D/S/K BELA		3838987 512820		
	TS/K BELA		3838987 316732		

Tuš kabine Tuš kabine		Program: SQ line			kolpa-san kolpa-san
Model	Naziv in dimenzija izdelka Naziv i dimenzije produkta	Opis Opis	EAN koda EAN koda	Cena EUR Cijena EUR	
Dodatki / Dodaci SQ line					
 <p>SDL</p> <p>STK-N</p> <p>STK</p>	<p>SDL</p> <p>STK-N</p> <p>STK</p>	<p>sedež za tuš kabino - višinsko nastavljiv sjedalo za tuš kabino - podesiv po visini</p> <p>sedež za tuš kabino z nogicami - preklopni sjedalo za tuš kabino sa nožicama - preklopni</p> <p>sedež za tuš kabino - preklopni sjedalo za tuš kabino - preklopni</p>	<p>3838987 593935</p> <p>3838987 573227</p> <p>3838987 950707</p>	<p>247,00</p> <p>183,00</p> <p>159,00</p>	
	KS	kopalniški stolček, h=40 cm, prenosni kupaonska stolica, h=40 cm, prenosni	3838987 950608	59,00	
	Mast za ležaje in tečaje tuš kabin Mast za ležajeve i šarke tuš kabina	krt = 10 x 20 ml (Cena za kos / Cijena na komad 4,70 EUR)	3838987 994169	47,00	
	EL-16	Brisalec stekla Brisač stakla	3838987 402732	19,00	
	<p>Specialno čistilo KOLPA SAN Specialno sredstvo za čiščenje</p> <p>Specialno čistilo ECO SAN Specialno sredstvo za čiščenje</p>	<p>krt = 20 x 0,5 l (Cena za kos / Cijena na komad 6,50 EUR)</p> <p>krt = 20 x 0,5 l (Cena za kos / Cijena na komad 5,70 EUR)</p>	<p>3838987 747291</p> <p>3838987 572220</p>	<p>130,00</p> <p>114,00</p>	





Tuš kabine Tuš kabine		Program: LUNA Silver profili, H=185		Silver profili. Kaljeno prozorno staklo (K), deblina stakla 4 mm. Silver profili. Kaljeno prozorno staklo (K), deblina stakla 4 mm.		kolpa·san	
Model	Naziv in dimenzija izdelka Naziv i dimenzije produkta	Opis Opis	EAN koda EAN koda	Cena EUR Cijena EUR			
TV3D/S 100/K, 90/K, 80/K							
	TV3D/S 100/K	tuš vrata - tridelna	3838987 510673	244,00			
	TV3D/S 90/K	tuš vrata - trodijelna	3838987 560067	239,00			
	TV3D/S 80/K		3838987 560050	231,00			
TSv3D 90/K, 80/K							
	TSv3D 90/K, deblina stakla 6 mm	tuš stena za kombinacijo s TV3D/S	3838987 560111	147,00			
	TSv3D 80/K, deblina stakla 6 mm	tuš stijena za kombinaciju sa TV3D/S	3838987 560104	139,00			
Dodatki / Dodaci LUNA							
	K-30 TV3D/S	kompensacijski profil za TV3D/S kompensacijski profil za TV3D/S	3838987 534167	37,00			



Program: LUNA Silver profili, H=185		Silver profili. Kaljeno prozorno staklo (K), deblina stakla 4 mm. Silver profili. Kaljeno prozorno staklo (K), deblina stakla 4 mm.			
TVZ/S 90/K, 80/K					
	TVZ/S 90 /K	samostojna zložljiva tuš vrata	3838987 534129	277,00	
	TVZ/S 80 /K	samostojeća sklopiva tuš vrata	3838987 534082	265,00	
TSvZ 90/K, 80/K					
	TSvZ 90/K, deblina stakla 6 mm	tuš stena za kombinacijo s TVZ/S	3838987 560111	147,00	
	TSvZ 80/K, deblina stakla 6 mm	tuš stijena za kombinaciju sa TVZ/S	3838987 560104	139,00	
Dodatki / Dodaci LUNA					
	K-30 TVZ/S	kompensacijski profil za TVZ/S kompensacijski profil za TVZ/S	3838987 534167	37,00	



Tuš kabine Tuš kabine	Program: LUNA Silver profili, H=190	Silver profili. Kaljeno prozorno (K), deblina stekla 6 mm. Silver profili. Kaljeno prozorno (K), deblina stakla 6 mm.	kolpa-san	
Model	Naziv in dimenzija izdelka Naziv i dimenzije produkta	Opis Opis	EAN koda EAN koda	Cena EUR Cijena EUR
TVO/S 90/K, 80/K				
	TVO/S 90/K TVO/S 80/K	samostojna tuš vrata, obračalna samostoječa tuš vrata, okretljiva	3838987 534211 3838987 534198	281,00 269,00
Dodatki / Dodaci Luna				
	K-25 TVO/S	kompensacijski profil za TVO/S Luna kompensacijski profil za TVO/S Luna	3838987 534150	46,00







POS. DIM. TSvZ/TSv3D/K				
	TSvZ/TSv3D/K SILVER	Posebne dimenzije Posebne dimenzije	3838987 960690	

Dodatki / Dodaci LUNA				
	SDL STK-N STK	sedež za tuš kabino - višinsko nastavljiv sjedalo za tuš kabino - podesiv po visini sedež za tuš kabino z nogicama - preklopni sjedalo za tuš kabino sa nožicama - preklopni sedež za tuš kabino - preklopni sjedalo za tuš kabino - preklopni	3838987 593935 3838987 573227 3838987 950707	247,00 183,00 159,00
	KS	kopalniški stolček, h=40 cm, prenosni kupaonska stolica, h=40 cm, prenosni	3838987 950608	59,00
	Mast za ležaje in tečaje tuš kabin Mast za ležajeve i šarke tuš kabina	krt = 10 x 20 ml (Cena za kos / Cijena na komad 4,70 EUR)	3838987 994169	47,00
	EL-16	Brisalec stekla Brisač stakla	3838987 402732	19,00
	EL-17 (Krom) EL-17B (Black)	obešalo za brisače, za na steklo tuš kabine vješalica za ručnike, za na staklo tuš kabine	3838987 402107 3838987 402114	17,00 20,00
	EL-09	dvojna viseča košarica za tuš kabino dvostruka viseća košarica za tuš kabinu	3838987 402664	136,00
	Specialno čistilo KOLPA SAN Specialno sredstvo za čišćenje Specialno čistilo ECO SAN Specialno sredstvo za čišćenje	krt = 20 x 0,5 l (Cena za kos / Cijena na komad 6,50 EUR) krt = 20 x 0,5 l (Cena za kos / Cijena na komad 5,70 EUR)	3838987 747291 3838987 572220	130,00 114,00
	www.kolpa.si	www.kolpa.hr		177



Tuš kabine Tuš kabine		Program: ECO QUAT Silver profili, H=185		Silver profili. Kaljeno prozorno staklo (K), debelina stakla 5 mm. Silver profili. Kaljeno prozorno staklo (K), debelina stakla 5 mm.		kolpa-san [®]	
Model	Naziv in dimenzija izdelka Naziv i dimenzije produkta	Opis Opis	EAN koda EAN koda	Cena EUR Cijena EUR			
TKK 90/K, 80/K		SNEMLJIVI VRATNI KRILI ODVOJIVA VRATNA KRILA					
	TKK 90/K	tuš kabina - kotna	3838987 538561	194,00			
	TKK 80/K	tuš kabina - kutna	3838987 538554	185,00			
TKP 90/K, 80/K R550		SNEMLJIVI VRATNI KRILI ODVOJIVA VRATNA KRILA					
	TKP 90/K R550	tuš kabina - polkrožna	3838987 538585	205,00			
	TKP 80/K R550	tuš kabina - polukružna	3838987 538578	194,00			

Tuš kabine Tuš kabine		Program: ECO QUAT BLACK profili, H=185		BLACK profili. Kaljeno prozorno staklo (K), debelina stakla 5 mm. BLACK profili. Kaljeno prozorno staklo (K), debelina stakla 5 mm.		kolpa-san [®]	
Model	Naziv in dimenzija izdelka Naziv i dimenzije produkta	Opis Opis	EAN koda EAN koda	Cena EUR Cijena EUR			
TKK 90/K, 80/K		SNEMLJIVI VRATNI KRILI ODVOJIVA VRATNA KRILA					
	TKK 90/K BLACK	tuš kabina - kotna	3838987 515289	214,00			
	TKK 80/K BLACK	tuš kabina - kutna	3838987 515234	204,00			
TKP 90/K, 80/K R550		SNEMLJIVI VRATNI KRILI ODVOJIVA VRATNA KRILA					
	TKP 90/K R550 BLACK	tuš kabina - polkrožna	3838987 515302	226,00			
	TKP 80/K R550 BLACK	tuš kabina - polukružna	3838987 515296	214,00			

Tuš kabine Tuš kabine		Program: ECO QUAT			kolpa-san kolpa-san
Model	Naziv in dimenzija izdelka Naziv i dimenzije produkta	Opis Opis	EAN koda EAN koda	Cena EUR Cijena EUR	
Dodatki / Dodaci ECO QUAT					
 <p>SDL</p> <p>STK-N</p>  <p>STK</p>	<p>SDL</p> <p>STK-N</p> <p>STK</p>	<p>sedež za tuš kabino - višinsko nastavljiv 3838987 593935 sjedalo za tuš kabino - podesiv po visini</p> <p>sedež za tuš kabino z nogicami - preklopni 3838987 573227 sjedalo za tuš kabino sa nožicama - preklopni</p> <p>sedež za tuš kabino - preklopni 3838987 950707 sjedalo za tuš kabino - preklopni</p>		<p>247,00</p> <p>183,00</p> <p>159,00</p>	
	KS	kopalniški stolček, h=40 cm, prenosni kupaonska stolica, h=40 cm, prenosni	3838987 950608	59,00	
	Mast za ležaje in tečaje tuš kabin Mast za ležajeve i šarke tuš kabina	krt = 10 x 20 ml (Cena za kos / Cijena na komad 4,70 EUR)	3838987 994169	47,00	
	EL-16	Brisalec stekla Brisač stakla	3838987 402732	19,00	
	<p>Specialno čistilo KOLPA SAN Specialno sredstvo za čiščenje</p> <p>Specialno čistilo ECO SAN Specialno sredstvo za čiščenje</p>	<p>krt = 20 x 0,5 l (Cena za kos / Cijena na komad 6,50 EUR)</p> <p>krt = 20 x 0,5 l (Cena za kos / Cijena na komad 5,70 EUR)</p>	<p>3838987 747291</p> <p>3838987 572220</p>	<p>130,00</p> <p>114,00</p>	





Zaslони za kopalne kadi

Paravani za kupaonske kade

Program: POLARIS, ANDROMEDA Silver brill in black profili, H=140

Silver brill in black profili. Kaljeno prozorno (/1) steklo, debelina stekla 8/6 mm, CLEAN COAT. / Silver brill in black profili. Kaljeno prozorno (/1) staklo, deblija stakla 8/6 mm, CLEAN COAT.

kolpa-san

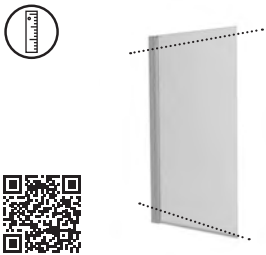
Model	Naziv in dimenzija izdelka Naziv i dimenzije produkta	Opis	EAN koda EAN koda	Cena EUR Cijena EUR
BS 80 -UNI SBR, B/1				
	BS 80 -UNI SBR/1 Silver brill	POLARIS enodelni krilni zaslon za kopalne kadi / jednodijelni krilni zaslon za kupaonske kade	3838987 517733	222,00
	BS 80 -UNI B/1 Black	UNIVERZALNI CLEAN COAT premaz	3838987 517740	232,00
BS 80 -UNI SBR, B/1-1P				
	BS 80 -UNI SBR/1-1P Silver brill	ANDROMEDA enodelni krilni zaslon za kopalne kadi, zložljiv na notranjo ali zunanjo stran / jednodijelni krilni zaslon za kupaonske kade, zložljiv na unutarnju ili vanjsku stranu	3838987 517757	260,00
	BS 80 -UNI B/1-1P Black	UNIVERZALNI CLEAN COAT premaz	3838987 517764	274,00
BS 120 -UNI SBR, B/1-2P				
	BS 120 -UNI SBR/1-2P Silver brill	ANDROMEDA dvodelni krilni zaslon za kopalne kadi / dvodijelni krilni zaslon za kupaonske kade	3838987 517771	396,00
	BS 120 -UNI B/1-2P Black	UNIVERZALNI CLEAN COAT premaz	3838987 517788	416,00
POS. DIM. BSSBR, B/1, 1-1P, 1-2P				
	POLARIS BS/SBR/1 Silver brill	Posebne dimenzije Posebne dimenzije	3838987 400370	
	POLARIS BS/B/1 Black		3838987 400387	
	ANDROMEDA BS/1P/SBR/1 Silver brill	3838987 400394		
	ANDROMEDA BS/1P/B/1 Black	3838987 400400		
	ANDROMEDA BS/2P/SBR/1 Silver brill	3838987 400417		
	ANDROMEDA BS/2P/B/1 Black	3838987 400420		

Dodatki / Dodaci

	EL-16	Brisalec stekla Brisač stakla	3838987 402732	19,00
	EL-17 (Krom)	obešalo za brisače, za na steklo tuš kabine vješalica za ručnike, za na staklo tuš kabine	3838987 402107	17,00
	EL-17B (Black)		3838987 402114	20,00
	Specialno čištilo KOLPA SAN Specialno sredstvo za čišćenje	krt = 20 x 0,5 l (Cena za kos / Cijena na komad 6,50 EUR)	3838987 747291	130,00
	Specialno čištilo ECO SAN Specialno sredstvo za čišćenje	krt = 20 x 0,5 l (Cena za kos / Cijena na komad 5,70 EUR)	3838987 572220	114,00

Zaslони za kopalne kadi
Paravani za kupaonske kade

Program: SOLE UNI
Silver profili, H=140

Silver profili. Kaljeno prozorno (K) steklo, debelina stekla 6 mm.
Silver profili, kaljeno prozirno (K) staklo, debjina stakla 6 mm.

kolpa-san®

Model	Naziv in dimenzija izdelka Naziv i dimenzije produkta	Opis Opis	EAN koda EAN koda	Cena EUR Cijena EUR
TP 102/K UNI				
	TP 102/K -UNI	dvodelni krilni zaslon za kopalno kad Royal, Divante dvodijelni krilni zaslon za kupaonksu kadu Royal, Divante UNIVERZALNI	3838987 514800	322,00
TP 104/K UNI				
	TP 104/K -UNI	dvodelni krilni zaslon za kop. kad Calando dvodijelni krilni zaslon za kup. kadu Calando UNIVERZALNI	3838987 514817	324,00

OPORA STEKLA ZA TP

	OPORA STEKLA ZA TP	kromirana cevna opora (ø 15) za stabilizacijo stekla pri TP 102, 104; l=52 cm kromirana cijevna potpora (ø 15) za stabilizacijo stakla kod TP 102, 104; l=52 cm	3838987 536079	48,00
-------------------------------------------------------------------------------------	---------------------------	---------------------------------------------------------------------------------------------------------------------------------------------------------------------------	-----------------------	--------------

Program: QUAT UNI
Silver profili, H=140

Silver dvizni profili. Kaljeno prozorno steklo (K), debelina stekla 5 mm.
Silver podizni profili. Kaljeno prozirno staklo (K), debjina stakla 5 mm.

TP 80/K UNI				
	TP 80/K -UNI	enodelni krilni zaslon za kopalne kadi jednodijelni krilni zaslon za kupaonske kade UNIVERZALNI	3838987 516989	174,00



Tuš kabine
Tuš kabine



Zaslони za kopalne kadi
Paravani za kupaonske kade**Program: QUAT UNI**
Beli profili, H=140BELI profili. Polistirensko steklo, debelina stakla 2 mm.
BIJELI profili. Polistirensko staklo, debljina stakla 2 mm.kolpa-san[®]

Model	Naziv in dimenzija izdelka Naziv i dimenzije produkta	Opis Opis	EAN koda EAN koda	Cena EUR Cijena EUR
TP 108 UNI				
	TP 108 -UNI	dvodelni krilni zaslon za kop. kad CALANDO dvodijelni krilni zaslon za kup. kade CALANDO UNIVERZALNI	3838987 726753	170,00
TP 105 UNI				
	TP 105 -UNI	dvodelni krilni zaslon za kop. kad ROYAL, DIVANTE dvodijelni krilni zaslon za kup. kade ROYAL, DIVANTE UNIVERZALNI	3838987 314356	165,00

Dodatki / Dodaci

	EL-16	Brisalec stakla Brisač stakla	3838987 402732	19,00
	Specialno čistilo KOLPA SAN Specialno sredstvo za čišćenje	krt = 20 x 0,5 l (Cena za kos / Cijena na komad 6,50 EUR)	3838987 747291	130,00
	Specialno čistilo ECO SAN Specialno sredstvo za čišćenje	krt = 20 x 0,5 l (Cena za kos / Cijena na komad 5,70 EUR)	3838987 572220	114,00



Model	Naziv in dimenzija izdelka Naziv i dimenzije produkta	Opis Opis	EAN koda EAN koda	Cena EUR Cijena EUR	
RE-WALL 160, 140, 120					
	Kerrock barva / Boja				
	RE-WALL 160x90	- white 109	Kerrock stena Kerrock stijena	3838987 551607	1.350,00
	RE-WALL 160x90	- andesite 9252		3838987 551614	1.465,00
	RE-WALL 160x80	- white 109	UNIVERZALNA	3838987 551584	1.297,00
	RE-WALL 160x80	- andesite 9252		3838987 551591	1.400,00
	RE-WALL 140x90	- white 109	Kerrock stena Kerrock stijena	3838987 551560	1.250,00
	RE-WALL 140x90	- andesite 9252		3838987 551577	1.350,00
	RE-WALL 140x80	- white 109	UNIVERZALNA	3838987 551546	1.193,00
	RE-WALL 140x80	- andesite 9252		3838987 551553	1.288,00
	RE-WALL 120x90	- white 109	Kerrock stena Kerrock stijena	3838987 551522	1.136,00
	RE-WALL 120x90	- andesite 9252		3838987 551539	1.226,00
	RE-WALL 120x80	- white 109	UNIVERZALNA	3838987 551508	1.078,00
RE-WALL 120x80	- andesite 9252		3838987 551515	1.167,00	
RE-WALL 100, 90, 80					
	RE-WALL 100x100	- white 109	Kerrock stena Kerrock stijena	3838987 551485	1.075,00
	RE-WALL 100x100	- andesite 9252		3838987 551492	1.161,00
	RE-WALL 90x90	- white 109	Kerrock stena Kerrock stijena	3838987 551447	1.045,00
	RE-WALL 90x90	- andesite 9252		3838987 551454	1.128,00
	RE-WALL 80x80	- white 109	Kerrock stena Kerrock stijena	3838987 551461	1.006,00
	RE-WALL 80x80	- andesite 9252		3838987 551478	1.089,00
RE-WALL POSEBNA DIMENZIJA					
	RE-WALL POSEBNA DIMENZIJA	Kerrock stena Kerrock stijena	3838987 551645		
		UNIVERZALNA			
Dodatki / Dodaci					
	KERIL - Specialno čistilo za KERROCK KERIL - Specijalno sredstvo	krt = 12 x 0,5 l (Cena za kos / Cijena na komad 4,50 EUR)	3838987 747307	54,00	
www.kolpa.si		www.kolpa.hr		183	







Kopalniško pohištvo Kupaonski namještaj

Alexis	186	Milo	203
Blanche	211	Naomi	227
Boul	207	Oxana	245
Donna	241	Pandora	215
Evelin	253	Ramona	209
Grace	199	Tara	235
Kiki	249	Vittoria	193
Lana	257	Samostojna ogledala, police	260
Malaya	211		



Demontirano, potrebna montaža / Rastavljeno, potrebna instalacija



Priložen sifon / Sifon uključen

LED - LED svetilka / LED svjetlo

T (Touch) - senzorsko stikalo
senzorski prekidač

SW (Switch) - stikalo / prekidač

S (Socket) - vtičnica / utičnica

C (Clock) - ura / sat

IR - senzorsko stikalo / senzorski prekidač

DIM - regulator intenzivnosti svetlobe regulator intenzivnosti svjetla

CCT - sprememba barve svetlobe (toplo - hladno bela) / regulator boje svjetlosti (toplo-hladno bijela)

(Š x V x G) - širina, višina, globina
širina, visina, dubina

2
leti garancije
godina jamstva

Slike so simbolične. Pravilna rasporeditev elementov je v TEHNIČNEM KATALOGU na www.kolpasan.si

Slike su simbolične. Točan raspored elemenata je u TEHNIČKOM KATALOGU na www.kolpasan.hr

Pridržujemo si pravico do spremembe podatkov. Dimenzije so informativnega značaja.
Zadržavamo si pravo do izmjene podataka. Dimenzije su informativnog karaktera.









Kopalniško pohištvo
Kupaonski namještaj

Program: ALEXIS

Fronte: MDF oplaćen s 3D folijo v dekorju – Dark Concrete (DC), Craft Wood (CW), Green (GN) Obod: Oplemenjena iverna ploča v dekorju (DC, CW, GN) Umivalnik: Kerrock / Fronte: MDF presvučen s 3D folijom u dekoru – Dark Concrete (DC), Craft Wood (CW), Green (GN) Obod: Oplemenjena iverna ploča u dekoru (DC, CW, GN) Umivaonik: Kerrock

kolpa-san

Model	Naziv in dimenzija izdelka Naziv i dimenzije produkta	Opis Opis	EAN koda EAN koda	Cena EUR Cijena EUR
OG Ø 150 -LED, IR, DIM				
	OG Ø 150 (Ø 120+ Ø 80) -LED, IR, DIM (2 ogledala /ogledala, 3 lučke/svjetla) 1500 x 1200 x 30	ogledalo z LED svetilko, senzorsko stikalo (IR), regulator intenzivnosti svetlobe (DIM) / ogledalo sa LED svjetlom, senzorski prekidač (IR), regulator intenzivnosti svjetla (DIM) LED barva/boja - NEUTRAL WHITE	3838987 546450	536,00
OG Ø 120, 100, 80 -LED, IR, DIM				
	OG Ø 120 -LED, IR, DIM (2 lučki/svjetla) OG Ø 100 -LED, IR, DIM OG Ø 80 -LED, IR, DIM	ogledalo z LED svetilko, senzorsko stikalo (IR), regulator intenzivnosti svetlobe (DIM) / ogledalo sa LED svjetlom, senzorski prekidač (IR), regulator intenzivnosti svjetla (DIM) LED barva/boja - NEUTRAL WHITE	3838987 573708 3838987 573692 3838987 573685	399,00 299,00 266,00
OG 100, 80, 60 -LED, T				
	OG 100 -LED, T 1000 x 700 x 20 OG 80 -LED, T 800 x 700 x 20 OG 60 -LED, T 600 x 700 x 20	ogledalo z integrirano ambientalno LED svetilko, senzorsko stikalo (T) ogledalo s integriranim ambientalnim LED svjetlom, senzorski prekidač (T) LED barva/boja - NEUTRAL WHITE	3838987 507260 3838987 507253 3838987 507246	311,00 275,00 254,00
OG 120, 100, 90, 80, 60 -LED, IR, DIM, CCT, C				
	OG 120 -LED, IR, DIM, CCT, C 1200 x 700 x 40 OG 100 -LED, IR, DIM, CCT, C 1000 x 700 x 40 OG 90 -LED, IR, DIM, CCT, C 900 x 700 x 40 OG 80 -LED, IR, DIM, CCT, C 800 x 700 x 40 OG 60 -LED, IR, DIM, CCT, C 600 x 700 x 40	ogl. z integ. LED svetilko, senzor. stikalo (IR), regulator inten. sv. (DIM), CCT - sprememba barve svetlobe (toplo-hladno bela) in uro (C) / ogledalo sa integ. LED svjetlom, senzor. prekidač (IR), regulator intenzivnosti svjetla (DIM), CCT - regulator boje svjetlosti (toplo-hladno bijela) i satom (C)	3838987 580157 3838987 580140 3838987 580133 3838987 580126 3838987 580119	340,00 313,00 293,00 277,00 256,00
OG 150, 120, 100, 80, 60				
	OG 150 1500 x 700 x 20 OG 120 1200 x 700 x 20 OG 100 1000 x 700 x 20 OG 80 800 x 700 x 20 OG 60 600 x 700 x 20	ogledalo, pravokotno ogledalo, pravokutno	3838987 547419 3838987 546443 3838987 547402 3838987 546436 3838987 547389	129,00 113,00 99,00 87,00 76,00
POLICA OG 150, 120, 100, 80, 60				
	POLICA OG 150 WH 1505 x 22 x 120 POLICA OG 120 WH 1205 x 22 x 120 POLICA OG 100 WH 1005 x 22 x 120 POLICA OG 80 WH 805 x 22 x 120 POLICA OG 60 WH 605 x 22 x 120	polica za pravokotno ogledalo s konzolo polica za pravokutnu ogledalo s konzolom	3838987 547471 3838987 546474 3838987 547464 3838987 547440 3838987 547426	76,00 68,00 61,00 54,00 47,00
KOZMETIČNO OGLEDALO				
	KOZMETIČNO OGLEDALO Ø 25	povečevalno ogledalo, okroglo uvečavajuće ogledalo, okruglo	3838987 546535	116,00
186	www.kolpa.si	www.kolpa.hr		







Kopalniško pohištvo

Kupaonski namještaj





Program: ALEXIS





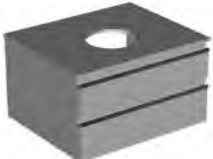

Fronte: MDF oplasčen s 3D folijo v dekorju – Dark Concrete (DC), Craft Wood (CW), Green (GN) Obod: Oplemenitena iverna plošča v dekorju (DC, CW, GN) Umivalnik: Kerrock / Fronte: MDF presvučen s 3D folijom u dekoru – Dark Concrete (DC), Craft Wood (CW), Green (GN) Obod: Oplemenjena iverna ploča u dekoru (DC, CW, GN) Umivaonik: Kerrock

kolpa-san

Model	Naziv in dimenzija izdelka Naziv i dimenzije produkta	Opis Opis	EAN koda EAN koda	Cena EUR Cijena EUR
TO 150, 120, 100 BL -LED, SW, S				
	TO 150 BL -LED, SW, S 1500 x 700 x 130 TO 120 BL -LED, SW, S 1200 x 700 x 130 TO 100 BL -LED, SW, S 1000 x 700 x 130	toaletna omarica z LED svetilko, stikalo (SW), vtičnica (S) toaletni ormarič s LED svetlom, prekidač (SW), utičnica (S) LED barva/boja - NEUTRAL WHITE	3838987 546511 3838987 546504 3838987 528876	691,00 608,00 554,00
TO 80 BL -LED, SW, S				
	TO 80 BL -LED, SW, S 800 x 700 x 130	toaletna omarica z LED svetilko, stikalo (SW), vtičnica (S) toaletni ormarič s LED svetlom, prekidač (SW), utičnica (S) LED barva/boja - NEUTRAL WHITE	3838987 528869	468,00
TO 60 BL -LED, SW, S				
	TO 60 BL -LED, SW, S 600 x 700 x 130	toaletna omarica z LED svetilko, stikalo (SW), vtičnica (S) toaletni ormarič s LED svetlom, prekidač (SW), utičnica (S) LED barva/boja - NEUTRAL WHITE	3838987 528852	370,00
UMIV. SOFT 550 ON GLOSS				
	UMIV. SOFT 550 ON GLOSS 550 x 120 x 360	umivalnik iz Kerrocka umivaonik od Kerrocka Priložen zgornji del sifona/ Uključen gornji dio sifona	3838987 863250	242,00
UMIV. SOFT 380 ON GLOSS				
	UMIV. SOFT 380 ON GLOSS Ø 380 x 120	umivalnik iz Kerrocka umivaonik od Kerrocka Priložen zgornji del sifona/ Uključen gornji dio sifona	3838987 864103	227,00
UMIV. LUX 500 ON GLOSS				
	UMIV. LUX 500 ON GLOSS 500 x 120 x 360	umivalnik iz Kerrocka umivaonik od Kerrocka Priložen zgornji del sifona/ Uključen gornji dio sifona	3838987 864127	242,00
UMIV. LUX 380 ON GLOSS				
	UMIV. LUX 380 ON GLOSS 380 x 380 x 120	umivalnik iz Kerrocka umivaonik od Kerrocka Priložen zgornji del sifona/ Uključen gornji dio sifona	3838987 864110	227,00
www.kolpa.hr		www.kolpa.si		187



Model	Naziv in dimenzija izdelka Naziv i dimenzije produkta	Opis Opis	EAN koda EAN koda	Cena EUR Cijena EUR
OA 150				
	OA 150 GN OA 150 CW OA 150 DC 1500 x 342 x 500 Ni izvrtine za armaturo / Nema rupe za armaturo	podumivalniška omarica s Kerrock polico in predaloma element ispod umivaonika s ladicom i policom od Kerrocka Priložen spodnji del sifona/ Uključen donji dio sifona	3838987 546306 3838987 547259 3838987 547266	796,00 796,00 796,00
OA 120				
	OA 120 GN OA 120 CW OA 120 DC 1200 x 342 x 500 Ni izvrtine za armaturo / Nema rupe za armaturo	podumivalniška omarica s Kerrock polico in predaloma element ispod umivaonika s ladicom i policom od Kerrocka Priložen spodnji del sifona/ Uključen donji dio sifona	3838987 547228 3838987 547235 3838987 547242	568,00 568,00 568,00
OA 100				
	OA 100 GN OA 100 CW OA 100 DC 1000 x 342 x 500 Ni izvrtine za armaturo / Nema rupe za armaturo	podumivalniška omarica s Kerrock polico in predaloma element ispod umivaonika s ladicom i policom od Kerrocka Priložen spodnji del sifona/ Uključen donji dio sifona	3838987 547204 3838987 547211 3838987 546283	507,00 507,00 507,00
OA 80				
	OA 80 GN OA 80 CW OA 80 DC 800 x 342 x 500 Ni izvrtine za armaturo / Nema rupe za armaturo	podumivalniška omarica s Kerrock polico in predaloma element ispod umivaonika s ladicom i policom od Kerrocka Priložen spodnji del sifona/ Uključen donji dio sifona	3838987 546276 3838987 547181 3838987 547198	466,00 466,00 466,00
OA 60				
	OA 60 GN OA 60 CW OA 60 DC 600 x 342 x 500 Ni izvrtine za armaturo / Nema rupe za armaturo	podumivalniška omarica s Kerrock polico in predaloma element ispod umivaonika s ladicom i policom od Kerrocka Priložen spodnji del sifona/ Uključen donji dio sifona	3838987 547167 3838987 546269 3838987 547174	427,00 427,00 427,00

Model	Naziv in dimenzija izdelka Naziv i dimenzije produkta	Opis Opis	EAN koda EAN koda	Cena EUR Cijena EUR	
A 1462/15					
	A 1462/15 GN	omarica z ogledalnimi vrati ormarič sa ogledalom na vratima	3838987 547334	200,00	
	A 1462/15 CW		3838987 547341	200,00	
	A 1462/15 DC		3838987 546344	200,00	
	450 x 1460 x 150				
A 1461/750					
	A 1461/750 GN	omarica z vrati in predaloma ormarič sa vratima i ladicama	3838987 547297	452,00	
	A 1461/750 CW		3838987 547303	452,00	
	A 1461/750 DC		3838987 546320	452,00	
	750 x 1460 x 320				
A 1461					
	A 1461 GN	omarica z vrati in predaloma ormarič sa vratima i ladicama	3838987 546313	345,00	
	A 1461 CW		3838987 547273	345,00	
	A 1461 DC		3838987 547280	345,00	
	450 x 1460 x 320				
A 1011					
	A 1011 GN	omarica z vrati in predaloma ormarič sa vratima i ladicama	3838987 547310	305,00	
	A 1011 CW		3838987 546337	305,00	
	A 1011 DC		3838987 547327	305,00	
	450 x 1010 x 320				
LUČ 700, 500 BL -LED					
 	LUČ 700 BL -LED	L=700	Svetilka (LED) za OG	3838987 547518	100,00
	LUČ 500 BL -LED	L=500	Svijetlo (LED) za OG	3838987 546542	92,00
			LED barva/boja - NEUTRAL WHITE		





Kopalniško pohištvo
Kupaonski namještaj

Program: ALEXIS

Fronte: MDF oplášen s 3D folijo v dekorju – Dark Concrete (DC), Craft Wood (CW), Green (GN) Obod:
Oplemenitena iverna ploša v dekorju (DC, CW, GN) Umivalnik: Kerrock / Fronte: MDF presvučen s 3D folijom u
dekoru – Dark Concrete (DC), Craft Wood (CW), Green (GN) Obod: Oplemenjena iverna ploša u dekoru (DC, CW, GN) Umivaonik:
Kerrock.

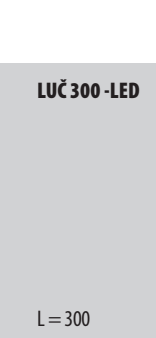
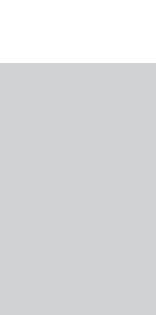
kolpa-san







Model	Naziv in dimenzija izdelka Naziv i dimenzije produkta	Opis Opis	EAN koda EAN koda	Cena EUR Cijena EUR
LUČ 300 -LED				
	LUČ 300 -LED L = 300	svetilka (LED) brez vtičnice in stikala za OG svjetlo (LED) bez utičnice i prekidača za OG LED barva/boja - NEUTRAL WHITE	3838987 509974	56,00
ORGANIZATOR PREDALA				
	ORGANIZATOR PREDALA ZG.350	za zgornji predal pri OA 120, 100 za gornju ladicu kod OA 120, 100	3838987 529477	42,00
	ORGANIZATOR PREDALA SP.350	za spodnji predal za donju ladicu	3838987 529491	45,00
NOGICE POHIŠTVA				
	NOGICE POHIŠTVA, h=40 cm	nogice za omarice, h=40 cm, (par) noge za ormariće, h=40 cm, (par)	3838987 505921	65,00





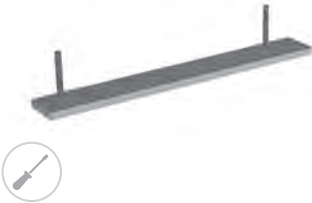

Kopalniško pohištvo
Kupaonski namještaj





Model	Naziv in dimenzija izdelka Naziv i dimenzije produkta	Opis Opis	EAN koda EAN koda	Cena EUR Cijena EUR
OG Ø 120, 100, 80 -LED, IR, DIM				
	OG Ø 120 -LED, IR, DIM (2 lučki/svjetla)	ogledalo z LED svetilko, senzorsko stikalo (IR), regulator intenzivnosti svetlobe (DIM) ogledalo sa LED svjetlom, senzorski prekidač (IR), regulator intenzivnosti svjetla (DIM) LED barva/boja - NEUTRAL WHITE	3838987 573708	399,00
	OG Ø 100 -LED, IR, DIM		3838987 573692	299,00
	OG Ø 80 -LED, IR, DIM		3838987 573685	266,00
OG 120, 100, 90, 80, 60 -LED, IR, DIM, CCT, C				
	OG 120 -LED, IR, DIM, CCT, C 1200 x 700 x 40	ogl. z integ. LED svetilko, senzorsko stikalo (IR), regulator inten. sv. (DIM), CCT - sprememba barve svetlobe (toplo-hladno bela) in uro (C) / ogledalo sa integ. LED svjetlom, senzor. prekidač (IR), regulator intenzivnosti svjetla (DIM), CCT - regulator boje svjetlosti (toplo-hladno bijela) i satom (C)	3838987 580157	340,00
	OG 100 -LED, IR, DIM, CCT, C 1000 x 700 x 40		3838987 580140	313,00
	OG 90 -LED, IR, DIM, CCT, C 900 x 700 x 40		3838987 580133	293,00
	OG 80 -LED, IR, DIM, CCT, C 800 x 700 x 40		3838987 580126	277,00
	OG 60 -LED, IR, DIM, CCT, C 600 x 700 x 40		3838987 580119	256,00
OG 100, 80, 60 -LED, T				
	OG 100 -LED, T	ogledalo z integrirano ambientalno LED svetilko, senzorsko stikalo (T) ogledalo s integriranim ambientalnim LED svjetlom, senzorski prekidač (T) LED barva/boja - NEUTRAL WHITE	3838987 507260	311,00
	OG 80 -LED, T		3838987 507253	275,00
	OG 60 -LED, T		3838987 507246	254,00
OG 120, 100, 80, 60				
	OG 120 1200 x 700 x 20	ogledalo, pravokotno ogledalo, pravokutno	3838987 546443	113,00
	OG 100 1000 x 700 x 20		3838987 547402	99,00
	OG 80 800 x 700 x 20		3838987 546436	87,00
	OG 60 600 x 700 x 20		3838987 547389	76,00
POLICA OG 120, 100, 80, 60				
	POLICA OG 120 WH 1205 x 22 x 120	polica za pravokotno ogledalo s konzolo polica za pravokutnu ogledalo s konzolom	3838987 546474	68,00
	POLICA OG 100 WH 1005 x 22 x 120		3838987 547464	61,00
	POLICA OG 80 WH 805 x 22 x 120		3838987 547440	54,00
	POLICA OG 60 WH 605 x 22 x 120		3838987 547426	47,00
KOZMETIČNO OGLEDALO				
	KOZMETIČNO OGLEDALO Ø 25	povečevalno ogledalo, okroglo uvećavajuće ogledalo, okruglo	3838987 546535	116,00



Model	Naziv in dimenzija izdelka Naziv i dimenzije produkta	Opis Opis	EAN koda EAN koda	Cena EUR Cijena EUR
TO 120, 100 BL -LED, SW, S				
	TO 120 BL -LED, SW, S 1200 x 700 x 130	toaletna omarica z LED svetilko, stikalo (SW), vtičnica (S) toaletni ormarič s LED svetlom, prekidač (SW), utičnica (S) LED barva/boja - NEUTRAL WHITE	3838987 546504	608,00
	TO 100 BL -LED, SW, S 1000 x 700 x 130		3838987 528876	554,00
TO 80 BL -LED, SW, S				
	TO 80 BL -LED, SW, S 800 x 700 x 130	toaletna omarica z LED svetilko, stikalo (SW), vtičnica (S) toaletni ormarič s LED svetlom, prekidač (SW), utičnica (S) LED barva/boja - NEUTRAL WHITE	3838987 528869	468,00
TO 60 BL -LED, SW, S				
	TO 60 BL -LED, SW, S 600 x 700 x 130	toaletna omarica z LED svetilko, stikalo (SW), vtičnica (S) toaletni ormarič s LED svetlom, prekidač (SW), utičnica (S) LED barva/boja - NEUTRAL WHITE	3838987 528852	370,00
OUV 120				
	OUV 120 WH	omariča z umivalnikom ormarič s umivaonikom Priložen spodnji in zgornji del sifona/ Uključen donji i gornji dio sifona	3838987 546214	965,00
	OUV 120 BE		3838987 547068	965,00
	OUV 120 DG		3838987 547075	965,00
	1200 x 472 x 500			
OUV 100				
	OUV 100 WH	omariča z umivalnikom ormarič s umivaonikom Priložen spodnji in zgornji del sifona/ Uključen donji i gornji dio sifona	3838987 547044	878,00
	OUV 100 BE		3838987 546207	878,00
	OUV 100 DG		3838987 547051	878,00
	1000 x 472 x 500			







Kopalniško pohištvo

Kupaonski namještaj

Program: VITTORIA

Fronte: Lakirani MDF – White (WH), Dark Grey (DG), Beige (BE), Obod: Oplemenitena iverna ploča v dekorju - White (WH), Dark Grey (DG), Beige (BE), Umivalnik: Liti Marmor / Fronte: Lakirani MDF – White (WH), Dark Grey (DG), Beige (BE), Obod: Oplemenjena iverna ploča U dekoru - White (WH), Dark Grey (DG), Beige (BE), Umivaonik: Liveni Mramor

kolpa-san®

Model	Naziv in dimenzija izdelka Naziv i dimenzije produkta	Opis Opis	EAN koda EAN koda	Cena EUR Cijena EUR
OUV 80				
	OUV 80 WH	omarica z umivalnikom ormarič s umivaonikom Priložen spodnji in zgornji del sifona/ Uključen donji i gornji dio sifona	3838987 547020	821,00
	OUV 80 BE		3838987 547037	821,00
	OUV 80 DG		3838987 546191	821,00
	800 x 472 x 500			
OUV 60				
	OUV 60 WH	omarica z umivalnikom ormarič s umivaonikom Priložen spodnji in zgornji del sifona/ Uključen donji i gornji dio sifona	3838987 546184	747,00
	OUV 60 BE		3838987 547006	747,00
	OUV 60 DG		3838987 547013	747,00
	600 x 472 x 500			
V 1481/790				
	V 1481/790 WH	omarica z vrati in predaloma ormarič sa vratima i ladicama	3838987 547082	555,00
	V 1481/790 BE		3838987 547099	555,00
	V 1481/790 DG		3838987 546221	555,00
	790 x 1475 x 320			
V 1481				
	V 1481 WH	omarica z vrati in predaloma ormarič sa vratima i ladicama	3838987 546238	403,00
	V 1481 BE		3838987 547105	403,00
	V 1481 DG		3838987 547112	403,00
	450 x 1475 x 320			
V 702/20				
	V 702/20 WH	omarica z vrati ormarič sa vratima	3838987 546252	140,00
	V 702/20 BE		3838987 547143	140,00
	V 702/20 DG		3838987 547150	140,00
	450 x 700 x 200			







Kopalniško pohištvo

Kupaonski namještaj

Program: VITTORIA

Fronte: Lakiran MDF – White (WH), Dark Grey (DG), Beige (BE), Obod: Oplemenitena iverna plošča v dekorju – White (WH), Dark Grey (DG), Beige (BE), Umivalnik: Liti Marmor / Fronte: Lakiran MDF – White (WH), Dark Grey (DG), Beige (BE), Obod: Oplemenjena iverna plošča U dekoru – White (WH), Dark Grey (DG), Beige (BE), Umivaonik: Livneni Marmor

kolpa-san

Model	Naziv in dimenzija izdelka Naziv i dimenzije produkta	Opis Opis	EAN koda EAN koda	Cena EUR Cijena EUR
OV 45				
	OV 45 WH	omaraica z vrati ormarič sa vratima	3838987 546245	217,00
	OV 45 BE		3838987 547129	217,00
	OV 45 DG		3838987 547136	217,00
	450 x 325 x 450			
LUČ 700, 500 BL -LED				
	LUČ 700 BL -LED L=700	Svetilka (LED) za OG Svjetlo (LED) za OG LED barva/boja - NEUTRAL WHITE	3838987 547518	100,00
	LUČ 500 BL -LED L=500		3838987 546542	92,00
LUČ 300 -LED				
	LUČ 300 -LED L = 300	svetilka (LED) brez vtičnice in stikala za OG svjetlo (LED) bez utičnice i prekidača za OG LED barva/boja - NEUTRAL WHITE	3838987 509974	56,00
NOGICE POHIŠTVA				
	NOGICE POHIŠTVA, h=40 cm	nogice za omaraice, h=40 cm, (par) noge za ormariče, h=40 cm, (par)	3838987 505921	65,00











Kopalniško pohištvo

Kupaonski namještaj





Program: GRACE

Fronte: Oplemenitena iverna plošča v dekorju – Halifax Oak (HO), Light Concrete (LC) Obod: Lakiran MDF – Black (BL) Umivalnik: Kerrock umivalnik delno vgrajen v Kerrock pult
Fronte: Oplemenjena iverna plošča u dekoru – Halifax Oak (HO), Light Concrete (LC) Obod: Lakiran MDF – Black (BL)
Umivaonik: Kerrock umivaonik dijelno ugrađen u Kerrock pult

kolpa-san

Model	Naziv in dimenzija izdelka Naziv i dimenzije produkta	Opis Opis	EAN koda EAN koda	Cena EUR Cijena EUR
OG Ø 150 -LED, IR, DIM				
	OG Ø 150 (Ø 120 + Ø 80) -LED, IR, DIM (2 ogledala /ogledala, 3 lučke/svjetla) 1500 x 1200 x 30	ogledalo z LED svetilko, senzorsko stikalo (IR), regulator intenzivnosti svetlobe (DIM) / ogledalo sa LED svjetlom, senzorski prekidač (IR), regulator intenzivnosti svjetla (DIM) LED barva/boja - NEUTRAL WHITE	3838987 546450	536,00
OG Ø 100, 80 -LED, IR, DIM				
	OG Ø 100 -LED, IR, DIM OG Ø 80 -LED, IR, DIM	ogledalo z LED svetilko, senzorsko stikalo (IR), regulator intenzivnosti svetlobe (DIM) / ogledalo sa LED svjetlom, senzorski prekidač (IR), regulator intenzivnosti svjetla (DIM) LED barva/boja - NEUTRAL WHITE	3838987 573692 3838987 573685	299,00 266,00
OG 100, 80 -LED, T				
	OG 100 -LED, T 1000 x 700 x 20 OG 80 -LED, T 800 x 700 x 20	ogledalo z integrirano ambientalno LED svetilko, senzorsko stikalo (T) ogledalo s integriranim ambientalnim LED svjetlom, senzorski prekidač (T) LED barva/boja - NEUTRAL WHITE	3838987 507260 3838987 507253	311,00 275,00
OG 120, 100, 90, 80, 60 -LED, IR, DIM, CCT, C				
	OG 120 -LED, IR, DIM, CCT, C 1200 x 700 x 40 OG 100 -LED, IR, DIM, CCT, C 1000 x 700 x 40 OG 90 -LED, IR, DIM, CCT, C 900 x 700 x 40 OG 80 -LED, IR, DIM, CCT, C 800 x 700 x 40 OG 60 -LED, IR, DIM, CCT, C 600 x 700 x 40	ogl. z integ. LED svetilko, senzor. stikalo (IR), regulator inten. sv. (DIM), CCT - sprememba barve svetlobe (toplo-hladno bela) in uro (C) / ogledalo sa integ. LED svjetlom, senzor. prekidač (IR), regulator intenzivnosti svjetla (DIM), CCT - regulator boje svjetlosti (toplo-hladno bijela) i satom (C)	3838987 580157 3838987 580140 3838987 580133 3838987 580126 3838987 580119	340,00 313,00 293,00 277,00 256,00
OG 150, 120, 100, 70				
	OG 150 1500 x 700 x 20 OG 100 1000 x 700 x 20 OG 70 700 x 700 x 20	ogledalo, pravokotno ogledalo, pravokutno	3838987 547419 3838987 547402 3838987 546412	129,00 99,00 80,00
POLICA OG 150, 100, 70				
	POLICA OG 150 WH 1505 x 22 x 120 POLICA OG 100 WH 1005 x 22 x 120 POLICA OG 70 WH 705 x 22 x 120	polica za pravokotno ogledalo s konzolo polica za pravokutnu ogledalo s konzolom	3838987 547471 3838987 547464 3838987 547433	76,00 61,00 49,00
KOZMETIČNO OGLEDALO				
	KOZMETIČNO OGLEDALO Ø 25	povečevalno ogledalo, okroglo uvečavajuće ogledalo, okruglo	3838987 546535	116,00
www.kolpa.hr		www.kolpa.si		199



Model	Naziv in dimenzija izdelka Naziv i dimenzije produkta	Opis Opis	EAN koda EAN koda	Cena EUR Cijena EUR
TO 150 BL -LED, SW, S				
	TO 150 BL -LED, SW, S 1500 x 700 x 130	toaletna omarica z LED svetilko, stikalo (SW), vtičnica (S) toaletni ormarič s LED svetlom, prekidač (SW), utičnica (S) LED barva/boja - NEUTRAL WHITE	3838987 546511	691,00
TO 100 BL -LED, SW, S				
	TO 100 BL -LED, SW, S 1000 x 700 x 130	toaletna omarica z LED svetilko, stikalo (SW), vtičnica (S) toaletni ormarič s LED svetlom, prekidač (SW), utičnica (S) LED barva/boja - NEUTRAL WHITE	3838987 528876	554,00
TO 70 BL -LED, SW, S				
	TO 70 BL -LED, SW, S 700 x 700 x 130	toaletna omarica z LED svetilko, stikalo (SW), vtičnica (S) toaletni ormarič s LED svetlom, prekidač (SW), utičnica (S) LED barva/boja - NEUTRAL WHITE	3838987 546498	422,00
OUG 150				
	OUG 150 LC OUG 150 HO 1500 x 444 x 520	omariča z umivalnikom ormarič s umivaonikom ima izvrtino za armaturo/ ima otvor za armaturo Priložen spodnji in zgornji del sifona/ Uključen donji i gornji dio sifona	3838987 546375 3838987 547372	1.402,00 1.402,00
	OUG 100 LC OUG 100 HO 1000 x 444 x 520	omariča z umivalnikom ormarič s umivaonikom ima izvrtino za armaturo/ ima otvor za armaturo Priložen spodnji in zgornji del sifona/ Uključen donji i gornji dio sifona	3838987 546368 3838987 547365	897,00 897,00







Kopalniško pohištvo

Kupaonski namještaj

Program: GRACE

Fronte: Oplemenitena iverna plošča v dekorju – Halifax Oak (HO), Light Concrete (LC) Obod: Lakiran MDF – Black (BL) Umivalnik: Kerrock umivalnik delno vgrajen v Kerrock pult
Fronte: Oplemenjena iverna plošča u dekoru – Halifax Oak (HO), Light Concrete (LC) Obod: Lakiran MDF – Black (BL)
Umivaonik: Kerrock umivaonik dijelno ugrađen u Kerrock pult





kolpa-san

Model	Naziv in dimenzija izdelka Naziv i dimenzije produkta	Opis Opis	EAN koda EAN koda	Cena EUR Cijena EUR
OUG 70				
	OUG 70 LC	omarica z umivalnikom ormarič s umivaonikom ima izvrtino za armaturo/ ima otvor za armaturo Priložen spodnji in zgornji del sifona/ Uključen donji i gornji dio sifona	3838987 547358	853,00
	OUG 70 HO		3838987 546351	853,00
	700 x 444 x 520			
G 1451				
	G 1451 LC	omarica z vrati in predaloma ormarič sa vratima i ladicama	3838987 546382	549,00
	G 1451 HO		3838987 546399	549,00
	500 x 1450 x 320			
LUČ 700, 500 BL -LED				
	LUČ 700 BL -LED L=700	Svetilka (LED) za OG Svjetlo (LED) za OG LED barva/boja - NEUTRAL WHITE	3838987 547518	100,00
	LUČ 500 BL -LED L=500		3838987 546542	92,00
LUČ 300 -LED				
	LUČ 300 -LED L = 300	svetilka (LED) brez vtičnice in stikala za OG svjetlo (LED) bez utičnice i prekidača za OG LED barva/boja - NEUTRAL WHITE	3838987 509974	56,00
ORGANIZATOR PREDALA				
	ORGANIZATOR PREDALA ZG.400	za zgornji predal pri OUG 100 za gornju ladicu kod OUG 100	3838987 529460	47,00
	ORGANIZATOR PREDALA SP.400	za spodnji predal za donju ladicu	3838987 529484	47,00
NOGICE POHIŠTVA				
	NOGICE POHIŠTVA, h=40 cm	nogice za omarice, h=40 cm, (par) noge za ormariče, h=40 cm, (par)	3838987 505921	65,00





Kopalniško pohištvo
Kupaonski namještaj







Model	Naziv in dimenzija izdelka Naziv i dimenzije produkta	Opis Opis	EAN koda EAN koda	Cena EUR Cijena EUR
Milo mirror 120x60				
	Milo mirror 120x60 -WHITE	ogledalo ogledalo	3838987 591603	296,00
Milo shelf 120x20				
	Milo shelf 120x20 -WHITE	polica polica	3838987 591610	148,00
Milo basin double + shelf 120x60 (180x60)				
	Milo basin double 120x60+SH. -WHITE	samostoječi dvojni umivalnik z belo polico, barva zunanjega dela; WHITE, BLACK, SAND, V.RED, L.GREEN, P.BLUE samostoječi dvostruki umivaonik sa bijelom policom, boja vanjskog dijela; WHITE, BLACK, SAND, V.RED, L.GREEN, P.BLUE	3838987 591542	992,00
	Milo basin double 120x60+SH. -BLACK&WHITE		3838987 592341	1.330,00
	Milo basin double 120x60+SH. -SAND&WHITE		3838987 592358	1.330,00
	Milo basin double 120x60+SH. -V.RED&WHITE		3838987 592365	1.330,00
	Milo basin double 120x60+SH. -L.GREEN&WHITE		3838987 592372	1.330,00
	Milo basin double 120x60+SH. -P.BLUE&WHITE		3838987 592389	1.330,00
Milo basin double 120x60				
	Milo basin double 120x60 -WHITE	samostoječi dvojni umivalnik barva zunanjega dela; WHITE, BLACK, SAND, V.RED, L.GREEN, P.BLUE samostoječi dvostruki umivaonik boja vanjskog dijela; WHITE, BLACK, SAND, V.RED, L.GREEN, P.BLUE	3838987 561620	949,00
	Milo basin double 120x60 -BLACK&WHITE		3838987 561637	1.285,00
	Milo basin double 120x60 -SAND&WHITE		3838987 561644	1.285,00
	Milo basin double 120x60 -V.RED&WHITE		3838987 561651	1.285,00
	Milo basin double 120x60 -L.GREEN&WHITE		3838987 561668	1.285,00
	Milo basin double 120x60 -P.BLUE&WHITE		3838987 561675	1.285,00



Model	Naziv in dimenzija izdelka Naziv i dimenzije produkta	Opis Opis	EAN koda EAN koda	Cena EUR Cijena EUR
Milo mirror 70x51				
	Milo mirror 70x51 -WHITE	ogledalo ogledalo	3838987 591627	150,00
Milo shelf 70x20				
	Milo shelf 70x20 -WHITE	polica polica	3838987 591634	90,00
Milo basin single + shelf 70x51 (101x51)				
	Milo basin single 70x51+SH. -WHITE	samostojeći enojni umivalnik z belo	3838987 591559	582,00
	Milo basin single 70x51+SH. -BLACK&WHITE	polico, s sifonom, barva zunanjega dela;	3838987 592396	790,00
	Milo basin single 70x51+SH. -SAND&WHITE	WHITE, BLACK, SAND, V.RED, L.GREEN, P.BLUE	3838987 592402	790,00
	Milo basin single 70x51+SH. -V.RED&WHITE	samostojeći jednostruki umivaonik sa bijelom	3838987 592419	790,00
	Milo basin single 70x51+SH. -L.GREEN&WHITE	policom, sa sifonom, boja vanjskog dijela;	3838987 592426	790,00
	Milo basin single 70x51+SH. -P.BLUE&WHITE	WHITE, BLACK, SAND, V.RED, L.GREEN, P.BLUE	3838987 592433	790,00
Milo basin single 70x51				
	Milo basin single 70x51 -WHITE	samostojeći enojni umivalnik	3838987 561682	557,00
	Milo basin single 70x51 -BLACK&WHITE	s sifonom, barva zunanjega dela; WHITE,	3838987 561699	764,00
	Milo basin single 70x51 -SAND&WHITE	BLACK, SAND, V.RED, L.GREEN, P.BLUE	3838987 561705	764,00
	Milo basin single 70x51 -V.RED&WHITE	samostojeći jednostruki umivaonik	3838987 561712	764,00
	Milo basin single 70x51 -L.GREEN&WHITE	sa sifonom, boja vanjskog dijela;	3838987 561729	764,00
	Milo basin single 70x51 -P.BLUE&WHITE	WHITE, BLACK, SAND, V.RED, L.GREEN, P.BLUE	3838987 592921	764,00















Model	Naziv in dimenzija izdelka Naziv i dimenzije produkta	Opis Opis	EAN koda EAN koda	Cena EUR Cijena EUR
Boul mirror 120x60				
	Boul mirror 120x60 -WHITE	Ogledalo Ogledalo	3838987 591641	296,00
Boul mirror Ø 60				
	Boul mirror Ø 60 -WHITE	Ogledalo Ogledalo	3838987 591665	194,00
Boul basin Ø 40				
	Boul basin Ø 40 -WHITE	Enojni umivalnik z izvlečnim odtočnim sistemom, s sifonom, barva zunanjega dela: WHITE, BLACK, SAND Jednostruki umivaonik s sustavom odvodnje na izvlačenje, sa sifonom, boja vanjskog dijela: WHITE, BLACK,SAND	3838987 591597	434,00
	Boul basin Ø 40 -BLACK&WHITE		3838987 592280	575,00
	Boul basin Ø 40 -SAND&WHITE		3838987 592297	575,00

















Kopalniško pohištvo Kupaonski namještaj	Program: RAMONA		Fronta in obod: MDF, lakiran, antracit MAT, Umivalnik: kerrock, Ročaj: kovinski, antracit, krtačen, Predali: tankostenski, kovinski mehko zapiranje <small>Fronta i obod: MDF, lakirano mat ANT, Umivaonik: kerrock, Ručka: metal, četkani efekt, Ladicе: metalni, s mekim zatvaranjem</small>		
Model	Naziv in dimenzija izdelka Naziv i dimenzije produkta	Opis Opis	EAN koda EAN koda	Cena EUR Cijena EUR	
OGR 60-LED, T, DIM, CCT NEW					
	OGR 60-LED, T, DIM, CCT NEW 630 x 750 x 61	ogledalo, LED ogledalna/ambientalna svetilka, senzorsko stikalo T (Touch), DIM regulator intenzivnosti svetlobe, CCT - sprememba barve svetlobe (toplo-hladno bela) / ogledalo s LED ogledalno/ambientalnim svetlom, senzorski prekidač T (Touch), DIM regulator intenzivnosti svetla, CCT regulator boje svetlosti (toplo-hladno bijela)	3838987 547747	731,00	
POLICA OGR 60/K					
	POLICA OGR 60/K 550 x 24 x 150	Kerrock polica Polica od Kerrocka	3838987 516590	102,00	
OUR 160 ANT					
  x2	OUR 160 ANT 1595 x 361,5 x 500	omara z dvojnimi umivalnikom ormarič sa duplim umivaonikom	3838987 538820	1.663,00	
OUR 80 ANT					
 	OUR 80 ANT 822 x 361,5 x 500	omara z umivalnikom ormarič s umivaonikom	3838987 514336	981,00	
R 1432/640 ANT					
	R 1432/640 ANT 638 x 1434 x 300	omara z vrati in policami ormarič sa vratima i ladicama	3838987 514367	743,00	
ORGANIZATOR PREDALA					
	ORGANIZATOR PREDALA ZG.350	za zgornji predal za gornju ladicu	3838987 529477	42,00	
Ramona basin 61x38x90					
	Ramona basin 61x38x90 - WHITE	samostoječi umivalnik samostoječi umivaonik	3838987 922612	977,00	
www.kolpa.si		www.kolpa.hr		209	











Model	Naziv in dimenzija izdelka Naziv i dimenzije produkta	Opis Opis	EAN koda EAN koda	Cena EUR Cijena EUR
OG Ø 150 -LED, IR, DIM				
	OG Ø 150 (Ø 120 + Ø 80) -LED, IR, DIM (2 ogledala /ogledala, 3 lučke/svjetla) 1500 x 1200 x 30	ogledalo z LED svetilko, senzorsko stikalo (IR), regulator intenzivnosti svetlobe (DIM) / ogledalo sa LED svjetlom, senzorski prekidač (IR), regulator intenzivnosti svjetla (DIM) LED barva/boja - NEUTRAL WHITE	3838987 546450	536,00
OG Ø 120, 100, 80 -LED, IR, DIM				
	OG Ø 120 -LED, IR, DIM (2 lučki/svjetla) OG Ø 100 -LED, IR, DIM OG Ø 80 -LED, IR, DIM	ogledalo z LED svetilko, senzorsko stikalo (IR), regulator intenzivnosti svetlobe (DIM) / ogledalo sa LED svjetlom, senzorski prekidač (IR), regulator intenzivnosti svjetla (DIM) LED barva/boja - NEUTRAL WHITE	3838987 573708 3838987 573692 3838987 573685	399,00 299,00 266,00
OG 100, 80 -LED, T				
	OG 100 -LED, T 1000 x 700 x 20 OG 80 -LED, T 800 x 700 x 20	ogledalo z integrirano ambientalno LED svetilko, senzorsko stikalo (T) ogledalo s integriranim ambientalnim LED svjetlom, senzorski prekidač (T) LED barva/boja - NEUTRAL WHITE	3838987 507260 3838987 507253	311,00 275,00
OG 120, 100, 90, 80, 60 -LED, IR, DIM, CCT, C				
	OG 120 -LED, IR, DIM, CCT, C 1200 x 700 x 40 OG 100 -LED, IR, DIM, CCT, C 1000 x 700 x 40 OG 90 -LED, IR, DIM, CCT, C 900 x 700 x 40 OG 80 -LED, IR, DIM, CCT, C 800 x 700 x 40 OG 60 -LED, IR, DIM, CCT, C 600 x 700 x 40	ogl. z integ. LED svetilko, senzor. stikalo (IR), regulator inten. sv. (DIM), CCT - sprememba barve svetlobe (toplo-hladno bela) in uro (C) / ogledalo sa integ. LED svjetlom, senzor. prekidač (IR), regulator intenzivnosti svjetla (DIM), CCT - regulator boje svjetlosti (toplo-hladno bijela) i satom (C)	3838987 580157 3838987 580140 3838987 580133 3838987 580126 3838987 580119	340,00 313,00 293,00 277,00 256,00
OG 150, 120, 100, 90, 80				
	OG 150 1500 x 700 x 20 OG 120 1200 x 700 x 20 OG 100 1000 x 700 x 20 OG 90 900 x 700 x 20 OG 80 800 x 700 x 20	ogledalo, pravokotno ogledalo, pravokutno	3838987 547419 3838987 546443 3838987 547402 3838987 547396 3838987 546436	129,00 113,00 99,00 92,00 87,00
POLICA OG 150, 120, 100, 90, 80				
 	POLICA OG 150 WH 1505 x 22 x 120 POLICA OG 120 WH 1205 x 22 x 120 POLICA OG 100 WH 1005 x 22 x 120 POLICA OG 90 WH 905 x 22 x 120 POLICA OG 80 WH 805 x 22 x 120	polica za pravokotno ogledalo s konzolo polica za pravokutnu ogledalo s konzolom	3838987 547471 3838987 546474 3838987 547464 3838987 547457 3838987 547440	76,00 68,00 61,00 58,00 54,00



Model	Naziv in dimenzija izdelka Naziv i dimenzije produkta	Opis Opis	EAN koda EAN koda	Cena EUR Cijena EUR
KOZMETIČNO OGLEDALO				
	KOZMETIČNO OGLEDALO Ø 25	povečevalno ogledalo, okroglo uvečavajuće ogledalo, okruglo	3838987 546535	116,00
OUM 140				
	OUM 140 DARK GRAY OUM 140 NATUR OAK 1410 x 412 x 500	omariča z dvojnimi umivalnikom ormarič sa duplim umivaonikom Priložen spodnji in zgornji del sifona/ Uključen donji i gornji dio sifona	3838987 573661 3838987 573678	1.258,00 1.258,00
OUM 100				
	OUM 100 DARK GRAY OUM 100 NATUR OAK 1010 x 412 x 500	omariča z umivalnikom ormarič s umivaonikom Priložen spodnji in zgornji del sifona/ Uključen donji i gornji dio sifona	3838987 573630 3838987 573647	807,00 807,00
OUM 80				
	OUM 80 DARK GRAY OUM 80 NATUR OAK 810 x 412 x 500	omariča z umivalnikom ormarič s umivaonikom Priložen spodnji in zgornji del sifona/ Uključen donji i gornji dio sifona	3838987 573609 3838987 573616	714,00 714,00
M 1301/1000				
	M 1301/1000 DARK GRAY M 1301/1000 NATUR OAK 1000 x 1300 x 318	omariča z vrati in predaloma ormarič sa vratima i ladicama	3838987 573784 3838987 573791	702,00 702,00

Model	Naziv in dimenzija izdelka Naziv i dimenzije produkta	Opis Opis	EAN koda EAN koda	Cena EUR Cijena EUR
M 1301				
	M 1301 DARK GRAY M 1301 NATUR OAK 450 x 1300 x 318	omarica z vrati in predaloma ormarič sa vratima i ladicama	3838987 573722 3838987 573739	458,00 458,00
M 1302/15				
	M 1302/15 DARK GRAY M 1302/15 NATUR OAK 450 x 1300 x 150	omarica z ogledalnimi vrati ormarič sa ogledalom na vratima	3838987 573753 3838987 573760	211,00 211,00
LUČ 700, 500 BL -LED				
	LUČ 700 BL -LED L=700 LUČ 500 BL -LED L=500	Svetilka (LED) za OG Svjetlo (LED) za OG LED barva/boja - NEUTRAL WHITE	3838987 547518 3838987 546542	100,00 92,00
LUČ 300 -LED				
	LUČ 300 -LED L = 300	svetilka (LED) brez vtičnice in stikala za OG / svjetlo (LED) bez utičnice i prekidača za OG LED barva/boja - NEUTRAL WHITE	3838987 509974	56,00
ORGANIZATOR PREDALA				
	ORGANIZATOR PREDALA ZG.350	za zgornji predal za gornju ladicu	3838987 529477	42,00
NOGICE POHIŠTVA				
	NOGICE POHIŠTVA, h=40 cm	nogice za omarice, h=40 cm, (par) nogice za ormariče, h=40 cm, (par)	3838987 505921	65,00









Kopalniško pohištvo
Kupaonski namještaj

Program: PANDORA





Umivalnik: liti marmor, obod: MDF lakiran, WH, vrata: lakiran MDF bela (WH); opl. iver. pljesen (NA), opl. iver. pl. črni kamen (BLACK STONE) / umivaonik: lijevani marmor, obod: MDF lakiran, WH, vrata: lakiran MDF bijela (WH); oplemenjena iverica jasen (NA); oplemenjena iverica crni kamen (BLACK STONE)

kolpa-san

Model	Naziv in dimenzija izdelka Naziv i dimenzije produkta	Opis Opis	EAN koda EAN koda	Cena EUR Cijena EUR
OG Ø 150 -LED, IR, DIM				
	OG Ø 150 (Ø 120 + Ø 80) -LED, IR, DIM (2 ogledala /ogledala, 3 lučke/svjetla) 1500 x 1200 x 30	ogledalo z LED svetilko, senzorsko stikalo (IR), regulator intenzivnosti svetlobe (DIM) ogledalo sa LED svjetlom, senzorski prekidač (IR), regulator intenzivnosti svjetla (DIM) LED barva/boja - NEUTRAL WHITE	3838987 546450	536,00
OG Ø 120, 100, 80 -LED, IR, DIM				
	OG Ø 120 -LED, IR, DIM (2 lučki/svjetla) OG Ø 100 -LED, IR, DIM OG Ø 80 -LED, IR, DIM	ogledalo z LED svetilko, senzorsko stikalo (IR), regulator intenzivnosti svetlobe (DIM) ogledalo sa LED svjetlom, senzorski prekidač (IR), regulator intenzivnosti svjetla (DIM) LED barva/boja - NEUTRAL WHITE	3838987 573708 3838987 573692 3838987 573685	399,00 299,00 266,00
OG 100, 80, -LED, T				
	OG 100 -LED, T 1000 x 700 x 20 OG 80 -LED, T 800 x 700 x 20	ogledalo z integrirano ambientalno LED svetilko, senzorsko stikalo (T) ogledalo s integriranim ambientalnim LED svjetlom, senzorski prekidač (T) LED barva/boja - NEUTRAL WHITE	3838987 507260 3838987 507253	311,00 275,00
OG 120, 100, 90, 80, 60 -LED, IR, DIM, CCT, C				
	OG 120 -LED, IR, DIM, CCT, C 1200 x 700 x 40 OG 100 -LED, IR, DIM, CCT, C 1000 x 700 x 40 OG 90 -LED, IR, DIM, CCT, C 900 x 700 x 40 OG 80 -LED, IR, DIM, CCT, C 800 x 700 x 40 OG 60 -LED, IR, DIM, CCT, C 600 x 700 x 40	ogl. z integ. LED svetilko, senzor. stikalo (IR), regulator inten. sv. (DIM), CCT - sprememba barve svetlobe (toplo-hladno bela) in uro (C) / ogledalo sa integ. LED svjetlom, senzor. prekidač (IR), regulator intenzivnosti svjetla (DIM), CCT - regulator boje svjetlosti (toplo-hladno bijela) i satom (C)	3838987 580157 3838987 580140 3838987 580133 3838987 580126 3838987 580119	340,00 313,00 293,00 277,00 256,00
OG 150, 120, 100, 90, 80, 70				
	OG 150 1500 x 700 x 20 OG 120 1200 x 700 x 20 OG 100 1000 x 700 x 20 OG 90 900 x 700 x 20 OG 80 800 x 700 x 20 OG 70 700 x 700 x 20	ogledalo, pravokotno ogledalo, pravokotno	3838987 547419 3838987 546443 3838987 547402 3838987 547396 3838987 546436 3838987 546412	129,00 113,00 99,00 92,00 87,00 80,00

Kopalniško pohištvo
Kupaonski namještaj



Model	Naziv in dimenzija izdelka Naziv i dimenzije produkta	Opis Opis	EAN koda EAN koda	Cena EUR Cijena EUR
POLICA OG 150, 120, 100, 90, 80, 70				
	<p>POLICA OG 150 WH 1505 x 22 x 120</p> <p>POLICA OG 120 WH 1205 x 22 x 120</p> <p>POLICA OG 100 WH 1005 x 22 x 120</p> <p>POLICA OG 90 WH 905 x 22 x 120</p> <p>POLICA OG 80 WH 805 x 22 x 120</p> <p>POLICA OG 70 WH 705 x 22 x 120</p>	<p>polica za pravokotno ogledalo s konzolo</p> <p>polica za pravokotnu ogledalo s konzolom</p>	<p>3838987 547471</p> <p>3838987 546474</p> <p>3838987 547464</p> <p>3838987 547457</p> <p>3838987 547440</p> <p>3838987 547433</p>	<p>76,00</p> <p>68,00</p> <p>61,00</p> <p>58,00</p> <p>54,00</p> <p>49,00</p>
KOZMETIČNO OGLEDALO				
	KOZMETIČNO OGLEDALO	ogledalo, okroglo ogledalo, okroglo	3838987 546535	116,00
TOP 150 -LED, SW, S				
	<p>TOP 150 WH -LED, SW, S</p> <p>1500 x 604 x 140</p>	<p>toaletna omarica z LED svetilko, stikalo (SW), vtičnica (S)</p> <p>toaletni ormarič s LED svetlom, prekidač (SW), utičnica (S)</p> <p>LED barva/boja - NEUTRAL WHITE</p>	3838987 514268	859,00
TOP 110 -LED, SW, S				
	<p>TOP 110 WH -LED, SW, S</p> <p>1100 x 604 x 140</p>	<p>toaletna omarica z LED svetilko, stikalo (SW), vtičnica (S)</p> <p>toaletni ormarič s LED svetlom, prekidač (SW), utičnica (S)</p> <p>LED barva/boja - NEUTRAL WHITE</p>	3838987 514251	650,00
TOP 75 -LED, SW, S				
	<p>TOP 75 WH -LED, SW, S</p> <p>750 x 604 x 140</p>	<p>toaletna omarica z LED svetilko, stikalo (SW), vtičnica (S)</p> <p>toaletni ormarič s LED svetlom, prekidač (SW), utičnica (S)</p> <p>LED barva/boja - NEUTRAL WHITE</p>	3838987 514244	551,00





Kopalniško pohištvo

Kupaonski namještaj

Program: PANDORA

Umivalnik: liti marmor, obod: MDF lakiran, WH, vrata: lakiran MDF bela (WH); opl. iver. pljesen (NA), opl. iver. pl. črni kamen (BLACK STONE) / umivaonik: lijevani mramor, obod: MDF lakiran, WH, vrata: lakiran MDF bijela (WH); oplemenjena iverica jasen (NA); oplemenjena iverica crni kamen (BLACK STONE)

kolpa-san





Model	Naziv in dimenzija izdelka Naziv i dimenzije produkta	Opis Opis	EAN koda EAN koda	Cena EUR Cijena EUR
OUP 150				
  x 2	OUP 150 WH	omarica z dvojnimi umivalnikom ormarič sa duplim umivaonikom Priložen spodnji del sifona/ Uključen donji dio sifona	3838987 514176	789,00
	OUP 150 NA		3838987 514206	789,00
	OUP 150 BLACK STONE		3838987 514237	789,00
1500 x 436 x 540				
OUP 110				
 	OUP 110 WH	omarica z umivalnikom ormarič s umivaonikom Priložen spodnji del sifona/ Uključen donji dio sifona	3838987 514169	610,00
	OUP 110 NA		3838987 514190	610,00
	OUP 110 BLACK STONE		3838987 514220	610,00
1100 x 436 x 540				
OUP 75				
 	OUP 75 WH	omarica z umivalnikom ormarič s umivaonikom Priložen spodnji del sifona/ Uključen donji dio sifona	3838987 514152	534,00
	OUP 75 NA		3838987 514183	534,00
	OUP 75 BLACK STONE		3838987 514213	534,00
750 x 436 x 540				
P 1302				
	P 1302 WH	omarica z vratima ormarič sa vratima	3838987 514305	369,00
	P 1302 NA		3838987 514312	369,00
	P 1302 BLACK STONE		3838987 514329	369,00
450 x 1300 x 350				
P 1301				
	P 1301 WH	omarica z vratima in predaloma ormarič sa vratima i ladicama	3838987 514275	437,00
	P 1301 NA		3838987 514282	437,00
	P 1301 BLACK STONE		3838987 514299	437,00
450 x 1300 x 350				







Model	Naziv in dimenzija izdelka Naziv i dimenzije produkta	Opis Opis	EAN koda EAN koda	Cena EUR Cijena EUR
LUČ 700, 500 BL -LED				
 	LUČ 700 BL -LED L=700	Svetilka (LED) za OG	3838987 547518	100,00
	LUČ 500 BL -LED L=500	Svjetlo (LED) za OG LED barva/boja - NEUTRAL WHITE	3838987 546542	92,00
LUČ 300 -LED				
 	LUČ 300 -LED L = 300	svetilka (LED) brez vtičnice in stikala za OG svjetlo (LED) bez utičnice i prekidača za OG LED barva/boja - NEUTRAL WHITE	3838987 509974	56,00
ORGANIZATOR PREDALA				
	ORGANIZATOR PREDALA ZG.400	za zgornji predal za gornju ladicu	3838987 529460	47,00
	ORGANIZATOR PREDALA SP.400	za spodnji predal za donju ladicu	3838987 529484	47,00
	KOZMETIČNI KOŠ 174 x 232 x 174	za spodnji predal za donju ladicu	3838987 529507	21,00
NOGICE POHIŠTVA				
 	NOGICE POHIŠTVA, h=40 cm	nogice za omarice, h=40 cm, (par) noge za ormariće, h=40 cm, (par)	3838987 505921	65,00











Model	Naziv in dimenzija izdelka Naziv i dimenzije produkta	Opis Opis	EAN koda EAN koda	Cena EUR Cijena EUR
OG Ø 150 -LED, IR, DIM				
	OG Ø 150 (Ø 120 + Ø 80) -LED, IR, DIM (2 ogledala /ogledala, 3 lučke/svjetla) 1500 x 1200 x 30	ogledalo z LED svetilko, senzorsko stikalo (IR), regulator intenzivnosti svetlobe (DIM) ogledalo sa LED svjetlom, senzorski prekidač (IR), regulator intenzivnosti svjetla (DIM) LED barva/boja - NEUTRAL WHITE	3838987 546450	536,00
OG Ø 120, 100, 80 -LED, IR, DIM				
	OG Ø 120 -LED, IR, DIM (2 lučki/svjetla) OG Ø 100 -LED, IR, DIM OG Ø 80 -LED, IR, DIM	ogledalo z LED svetilko, senzorsko stikalo (IR), regulator intenzivnosti svetlobe (DIM) ogledalo sa LED svjetlom, senzorski prekidač (IR), regulator intenzivnosti svjetla (DIM) LED barva/boja - NEUTRAL WHITE	3838987 573708 3838987 573692 3838987 573685	399,00 299,00 266,00
OG 100, 80, -LED, T				
	OG 100 -LED, T 1000 x 700 x 20 OG 80 -LED, T 800 x 700 x 20	ogledalo z integrirano ambientalno LED svetilko, senzorsko stikalo (T) ogledalo s integriranim ambientalnim LED svjetlom, senzorski prekidač (T) LED barva/boja - NEUTRAL WHITE	3838987 507260 3838987 507253	311,00 275,00
OG 120, 100, 90, 80, 60 -LED, IR, DIM, CCT, C				
	OG 120 -LED, IR, DIM, CCT, C 1200 x 700 x 40 OG 100 -LED, IR, DIM, CCT, C 1000 x 700 x 40 OG 90 -LED, IR, DIM, CCT, C 900 x 700 x 40 OG 80 -LED, IR, DIM, CCT, C 800 x 700 x 40 OG 60 -LED, IR, DIM, CCT, C 600 x 700 x 40	ogl. z integ. LED svetilko, senz. stikalo (IR), regulator inten. sv. (DIM), CCT - sprememba barve svetlobe (toplo-hladno bela) in uro (C) / ogledalo sa integ. LED svjetlom, senzor. prekidač (IR), regulator intenzivnosti svjetla (DIM), CCT - regulator boje svjetlosti (toplo-hladno bijela) i satom (C)	3838987 580157 3838987 580140 3838987 580133 3838987 580126 3838987 580119	340,00 313,00 293,00 277,00 256,00
OG 150, 120, 100, 90, 80, 70				
	OG 150 1500 x 700 x 20 OG 120 1200 x 700 x 20 OG 100 1000 x 700 x 20 OG 90 900 x 700 x 20 OG 80 800 x 700 x 20 OG 70 700 x 700 x 20	ogledalo, pravokotno ogledalo, pravokutno	3838987 547419 3838987 546443 3838987 547402 3838987 547396 3838987 546436 3838987 546412	129,00 113,00 99,00 92,00 87,00 80,00



Model	Naziv in dimenzija izdelka Naziv i dimenzije produkta	Opis Opis	EAN koda EAN koda	Cena EUR Cijena EUR
POLICA OG 150, 120, 100, 90, 80, 70				
	<p>POLICA OG 150 WH 1505 x 22 x 120</p> <p>POLICA OG 120 WH 1205 x 22 x 120</p> <p>POLICA OG 100 WH 1005 x 22 x 120</p> <p>POLICA OG 90 WH 905 x 22 x 120</p> <p>POLICA OG 80 WH 805 x 22 x 120</p> <p>POLICA OG 70 WH 705 x 22 x 120</p>	<p>polica za pravokotno ogledalo s konzolo</p> <p>polica za pravokotnu ogledalo s konzolom</p>	<p>3838987 547471</p> <p>3838987 546474</p> <p>3838987 547464</p> <p>3838987 547457</p> <p>3838987 547440</p> <p>3838987 547433</p>	<p>76,00</p> <p>68,00</p> <p>61,00</p> <p>58,00</p> <p>54,00</p> <p>49,00</p>
KOZMETIČNO OGLEDALO				
	KOZMETIČNO OGLEDALO Ø 25	povečevalno ogledalo, okroglo uvečavajuće ogledalo, okruglo	3838987 546535	116,00
TOB 145 -LED, SW, S				
	<p>TOB 145 WH -LED, SW, S</p> <p>TOB 145 ANT -LED, SW, S</p> <p>1450 x 700 x 142</p>	<p>toaletna omarica z LED svetilko, stikalo (SW), vtičnica (S)</p> <p>toaletni ormarič s LED svjetlom, prekidač (SW), utičnica (S)</p> <p>LED barva/boja - NEUTRAL WHITE</p>	<p>3838987 561170</p> <p>3838987 561569</p>	<p>532,00</p> <p>532,00</p>
TOB 95 -LED, SW, S				
	<p>TOB 95 WH -LED, SW, S</p> <p>TOB 95 ANT -LED, SW, S</p> <p>950 x 700 x 142</p>	<p>toaletna omarica z LED svetilko, stikalo (SW), vtičnica (S)</p> <p>toaletni ormarič s LED svjetlom, prekidač (SW), utičnica (S)</p> <p>LED barva/boja - NEUTRAL WHITE</p>	<p>3838987 538851</p> <p>3838987 561552</p>	<p>417,00</p> <p>417,00</p>
TOB 70 -LED, SW, S				
	<p>TOB 70 WH -LED, SW, S</p> <p>TOB 70 ANT -LED, SW, S</p> <p>700 x 700 x 142</p>	<p>toaletna omarica z LED svetilko, stikalo (SW), vtičnica (S)</p> <p>toaletni ormarič s LED svjetlom, prekidač (SW), utičnica (S)</p> <p>LED barva/boja - NEUTRAL WHITE</p>	<p>3838987 561811</p> <p>3838987 561828</p>	<p>369,00</p> <p>369,00</p>

Model	Naziv in dimenzija izdelka Naziv i dimenzije produkta	Opis Opis	EAN koda EAN koda	Cena EUR Cijena EUR
UB 530 ON WH - UMIV. BLA.				
	UB 530 ON WH - UMIVALNIK BLANCHE	umivalnik iz litega marmorja	3838987 563266	250,00
	UB 530 ON WH/ANT - UMIVALNIK BLANCHE	umivaonik od lijevanog mramora	3838987 563273	309,00
		Priložen zgornji del sifona/ Uključen gornji dio sifona		
OB 150				
	OB 150 WH	podumivalniška omarica s predalom in kerrock odlagalno površino / element ispod umivaonika s ladicom i površinom za odlaganje od Kerrocka	3838987 547723	859,00
	OB 150 ANT		3838987 547730	859,00
	Ni izvrtine za armaturo / Nema rupe za armaturo			
	1488 x 280 x 525			
OB 110				
	OB 110 WH	podumivalniška omarica s predalom in kerrock odlagalno površino / element ispod umivaonika s ladicom i površinom za odlaganje od Kerrocka	3838987 547709	605,00
	OB 110 ANT		3838987 547716	605,00
	Ni izvrtine za armaturo / Nema rupe za armaturo			
	1088 x 280 x 525			
OB 75				
	OB 75 WH	podumivalniška omarica s predalom in kerrock odlagalno površino / element ispod umivaonika s ladicom i površinom za odlaganje od Kerrocka	3838987 547686	503,00
	OB 75 ANT		3838987 547693	503,00
	Ni izvrtine za armaturo / Nema rupe za armaturo			
	688 x 280 x 525			
B 1323				
	B 1323 WH	omariča z vratima	3838987 514145	265,00
	B 1323 ANT	ormarič sa vratima	3838987 514121	265,00
	454 x 1321 x 300			









Model	Naziv in dimenzija izdelka Naziv i dimenzije produkta	Opis	EAN koda EAN koda	Cena EUR Cijena EUR
B 923				
	B 923 WH	omariča z vrati ormarič sa vratima	3838987 514114	238,00
	B 923 ANT		3838987514091	238,00
	454 x 918 x 300			
ORGANIZATOR PREDALA				
	ORGANIZATOR PREDALA ZG.400	za zgornji predal za gornju ladicu	3838987 529460	47,00
LUČ 700, 500 BL -LED				
 	LUČ 700 BL -LED L=700	Svetilka (LED) za OG Svjetlo (LED) za OG LED barva/boja - NEUTRAL WHITE	3838987 547518	100,00
	LUČ 500 BL -LED L=500		3838987 546542	92,00
LUČ 300 -LED				
 	LUČ 300 -LED L = 300	svetilka (LED) brez vtičnice in stikala za OG svjetlo (LED) bez utičnice i prekidača za OG LED barva/boja - NEUTRAL WHITE	3838987 509974	56,00
NOGICE POHIŠTVA				
 	NOGICE POHIŠTVA, h=40 cm	nogice za omariče, h=40 cm, (par) noge za ormariče, h=40 cm, (par)	3838987 505921	65,00







Kopalniško pohištvo
Kupaonski namještaj















Model	Naziv in dimenzija izdelka Naziv i dimenzije produkta	Opis Opis	EAN koda EAN koda	Cena EUR Cijena EUR
OG Ø 120, 100, 80 -LED, IR, DIM				
	OG Ø 120 -LED, IR, DIM (2 lučki/svjetla)	ogledalo z LED svetilko, senzorsko stikalo (IR), regulator intenzivnosti svetlobe (DIM) ogledalo sa LED svjetlom, senzorski prekidač (IR), regulator intenzivnosti svjetla (DIM) LED barva/boja - NEUTRAL WHITE	3838987 573708	399,00
	OG Ø 100 -LED, IR, DIM		3838987 573692	299,00
	OG Ø 80 -LED, IR, DIM		3838987 573685	266,00
OG 100, 80, 60 -LED, T				
	OG 100 -LED, T 1000 x 700 x 20	ogledalo z integrirano ambientalno LED svetilko, senzorsko stikalo (T) ogledalo s integriranim ambientalnim LED svjetlom, senzorski prekidač (T) LED barva/boja - NEUTRAL WHITE	3838987 507260	311,00
	OG 80 -LED, T 800 x 700 x 20		3838987 507253	275,00
	OG 60 -LED, T 600 x 700 x 20		3838987 507246	254,00
OG 120, 100, 90, 80, 60 -LED, IR, DIM, CCT, C				
	OG 120 -LED, IR, DIM, CCT, C 1200 x 700 x 40	ogl. z integ. LED svetilko, senz. stikalo (IR), regulator inten. sv. (DIM), CCT - sprememba barve svetlobe (toplo-hladno bela) in uro (C) / ogledalo sa integ. LED svijetlom, senzor. prekidač (IR), regulator intenzivnosti svjetla (DIM), CCT - regulator boje svjetlosti (toplo-hladno bijela) i satom (C)	3838987 580157	340,00
	OG 100 -LED, IR, DIM, CCT, C 1000 x 700 x 40		3838987 580140	313,00
	OG 90 -LED, IR, DIM, CCT, C 900 x 700 x 40		3838987 580133	293,00
	OG 80 -LED, IR, DIM, CCT, C 800 x 700 x 40		3838987 580126	277,00
	OG 60 -LED, IR, DIM, CCT, C 600 x 700 x 40		3838987 580119	256,00
OG 120, 100, 90, 80, 70, 60, 50				
	OG 120 1200 x 700 x 20	ogledalo, pravokotno ogledalo, pravokutno	3838987 546443	113,00
	OG 100 1000 x 700 x 20		3838987 547402	99,00
	OG 90 900 x 700 x 20		3838987 547396	92,00
	OG 80 800 x 700 x 20		3838987 546436	87,00
	OG 70 700 x 700 x 20		3838987 546412	80,00
	OG 60 600 x 700 x 20		3838987 547389	76,00
	OG 50 500 x 700 x 20		3838987 546405	62,00
POLICA OG 120, 100, 80, 60, 50				
 	POLICA OG 120 WH 1205 x 22 x 120	polica za pravokotno ogledalo s konzolo polica za pravokutnu ogledalo s konzolom	3838987 546474	68,00
	POLICA OG 100 WH 1005 x 22 x 120		3838987 547464	61,00
	POLICA OG 90 WH 905 x 22 x 120		3838987 547457	58,00
	POLICA OG 80 WH 805 x 22 x 120		3838987 547440	54,00
	POLICA OG 70 WH 705 x 22 x 120		3838987 547433	49,00
	POLICA OG 60 WH 605 x 22 x 120		3838987 547426	47,00
	POLICA OG 50 WH 505 x 22 x 120		3838987 546467	44,00



Model	Naziv in dimenzija izdelka Naziv i dimenzije produkta	Opis Opis	EAN koda EAN koda	Cena EUR Cijena EUR
KOZMETIČNO OGLEDALO				
	KOZMETIČNO OGLEDALO Ø 25	povečevalno ogledalo, okroglo uvečavajuće ogledalo, okruglo	3838987 546535	116,00
TON 120, 100				
	TON 120 WH 1200 x 700 x 130	toaletna omarica toaletni ormarič	3838987 546825	249,00
	TON 120 NW		3838987 546832	249,00
	TON 120 DC		3838987 546849	249,00
	TON 100 WH 1000 x 700 x 130	toaletna omarica toaletni ormarič	3838987 546801	224,00
	TON 100 NW		3838987 546078	224,00
	TON 100 DC		3838987 546085	224,00
TON 80, 70				
	TON 80 WH 800 x 700 x 130	toaletna omarica toaletni ormarič	3838987 546771	188,00
	TON 80 NW		3838987 546788	188,00
	TON 80 DC		3838987 546795	188,00
	TON 70 WH 700 x 700 x 130	toaletna omarica toaletni ormarič	3838987 546740	177,00
	TON 70 NW		3838987 546757	177,00
	TON 70 DC		3838987 546764	177,00
TON 60, 50				
	TON 60 WH 600 x 700 x 130	toaletna omarica toaletni ormarič	3838987 546726	138,00
	TON 60 NW		3838987 546061	138,00
	TON 60 DC		3838987 546733	138,00
	TON 50 WH 500 x 700 x 130	toaletna omarica toaletni ormarič	3838987 546696	131,00
	TON 50 NW		3838987 546702	131,00
	TON 50 DC		3838987 546719	131,00
OUN 120				
	OUN 120 WH	omara z umivalnikom ormarič s umivaonikom	3838987 546672	544,00
	OUN 120 NW		3838987 546689	544,00
	OUN 120 DC		3838987 546054	544,00
	1200 x 495 x 450	Priložen spodnji del sifona/ Uključen donji dio sifona		

Model	Naziv in dimenzija izdelka Naziv i dimenzije produkta	Opis Opis	EAN koda EAN koda	Cena EUR Cijena EUR
OUN 100				
	OUN 100 WH	ormarica z umivalnikom ormarič s umivaonikom Priložen spodnji del sifona/ Uključen donji dio sifona	3838987 546658	486,00
	OUN 100 NW		3838987 546047	486,00
	OUN 100 DC		3838987 546665	486,00
1000 x 495 x 450				
OUN 80				
	OUN 80 WH	ormarica z umivalnikom ormarič s umivaonikom Priložen spodnji del sifona/ Uključen donji dio sifona	3838987 546030	459,00
	OUN 80 NW		3838987 546634	459,00
	OUN 80 DC		3838987 546641	459,00
800 x 495 x 450				
OUN 70				
	OUN 70 WH	ormarica z umivalnikom ormarič s umivaonikom Priložen spodnji del sifona/ Uključen donji dio sifona	3838987 546610	423,00
	OUN 70 NW		3838987 546627	423,00
	OUN 70 DC		3838987 546023	423,00
700 x 495 x 450				
OUN 60				
	OUN 60 WH	ormarica z umivalnikom ormarič s umivaonikom Priložen spodnji del sifona/ Uključen donji dio sifona	3838987 546597	408,00
	OUN 60 NW		3838987 546016	408,00
	OUN 60 DC		3838987 546603	408,00
600 x 495 x 450				
OUN 50				
	OUN 50 WH	ormarica z umivalnikom ormarič s umivaonikom Priložen spodnji del sifona/ Uključen donji dio sifona	3838987 546009	366,00
	OUN 50 NW		3838987 546573	366,00
	OUN 50 DC		3838987 546580	366,00
500 x 495 x 400				







Model	Naziv in dimenzija izdelka Naziv i dimenzije produkta	Opis Opis	EAN koda EAN koda	Cena EUR Cijena EUR
ON 60				
	ON 60 WH	omarica s predaloma ormarič sa ladicama	3838987 546146	228,00
	ON 60 NW		3838987 546955	228,00
	ON 60 DC		3838987 546962	228,00
	590 x 325 x 454			
ON 40				
	ON 40 WH	omarica z vratii ormarič sa vratima	3838987 546917	124,00
	ON 40 NW		3838987 546122	124,00
	ON 40 DC		3838987 546924	124,00
	400 x 454 x 325			
N 1501/790				
	N 1501/790 WH	omarica z vratii in predaloma ormarič sa vratima i ladicama	3838987 546856	406,00
	N 1501/790 NW		3838987 546863	406,00
	N 1501/790 DC		3838987 546092	406,00
	790 x 1495 x 320			
N 1501				
	N 1501 WH	omarica z vratii in predaloma ormarič sa vratima i ladicama	3838987 546108	308,00
	N 1501 NW		3838987 546870	308,00
	N 1501 DC		3838987 546887	308,00
	400 x 1495 x 320			
N 1500/30				
	N 1500/30 WH	odprta omarica otvoren ormarič	3838987 546894	150,00
	N 1500/30 NW		3838987 546900	150,00
	N 1500/30 DC		3838987 546115	150,00
	300 x 1495 x 320			

Kopalniško pohištvo
Kupaonski namještaj

Program: NAOMI





Fronte: MDF oplasčen s 3D folijo v dekorju – White (WH), Dark Concrete (DC), Natural Wood (NW) Obod:
Oplemenitena iverna plošča v dekorju - White (WH), Dark Concrete (DC), Natural Wood (NW) Umivalnik:
Liti Marmor / Fronte: MDF presvučena s 3D folijom u dekoru – White (WH), Dark Concrete (DC), Natural Wood (NW) Obod:
presvučena oplemenjena iverna ploča u dekoru - White (WH), Dark Concrete (DC), Natural Wood (NW) Umivaonik: Ljevani Mramor

kolpa-san

Model	Naziv in dimenzija izdelka Naziv i dimenzije produkta	Opis	EAN koda EAN koda	Cena EUR Cijena EUR
N 702/600/20				
	N 702/600/20 WH	omarica z vrati ormarič sa vratima	3838987 546153	128,00
	N 702/600/20 NW		3838987 546979	128,00
	N 702/600/20 DC		3838987 546986	128,00
	590 x 700 x 200			
N 702/20				
	N 702/20 WH	omarica z vrati ormarič sa vratima	3838987 546931	112,00
	N 702/20 NW		3838987 546139	112,00
	N 702/20 DC		3838987 546948	112,00
	400 x 700 x 200			
N 700/13				
	N 700/13 WH	odprta omarica otvoren ormarič	3838987 546160	62,00
	N 700/13 NW		3838987 546177	62,00
	N 700/13 DC		3838987 546993	62,00
	200 x 700 x 130			
LUČ 700, 500 BL BOX-LED, SW, S				
	LUČ 700 BL BOX -LED, SW, S L=700	Svetilka (LED), stikalo (SW), vtičnica (S), BOX za TON / Svjetlo (LED), prekidač (SW), utičnica (S), BOX za TON	3838987 546566	135,00
	LUČ 500 BL BOX -LED, SW, S L=500		3838987 546559	128,00
		LED barva/boja - NEUTRAL WHITE		
LUČ 700, 500 BL -LED				
	LUČ 700 BL -LED L=700	Svetilka (LED) za OG in TON Svjetlo (LED) za OG i TON	3838987 547518	100,00
	LUČ 500 BL -LED L=500		3838987 546542	92,00
		LED barva/boja - NEUTRAL WHITE		

Kopalniško pohištvo
Kupaonski namještaj

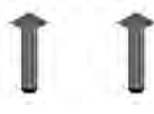

Model	Naziv in dimenzija izdelka Naziv i dimenzije produkta	Opis Opis	EAN koda EAN koda	Cena EUR Cijena EUR
LUČ 500 BOX -LED, SW, S				
 	LUČ 500 BOX -LED, SW, S L = 500	svetilka (LED), stikalo (SW), vtičnica (S), BOX za toaletno omarico TON /svjetlo (LED), prekidač (SW), utičnica (S), BOX za toaletni omarič TON LED barva/boja - NEUTRAL WHITE	3838987 300298	122,00
LUČ 300 -LED				
 	LUČ 300 -LED L = 300	svetilka (LED) brez vtičnice in stikala za TON in OG svjetlo (LED) bez utičnice i prekidača za TON i OG LED barva/boja - NEUTRAL WHITE	3838987 509974	56,00
ORGANIZATOR PREDALA				
	ORGANIZATOR PREDALA ZG.350	za zgornji predal pri OUN 120 za gornju ladicu kod OUN 120	3838987 529477	42,00
	ORGANIZATOR PREDALA SP.350	za spodnji predal za donju ladicu Samo za: OUN 120, 100, 80, 70, 60	3838987 529491	45,00
NOGICE POHIŠTVA				
 	NOGICE POHIŠTVA, h=20 cm	nogice za omarice, h=20 cm, (par) noge za ormariče, h=20 cm, (par)	3838987 505914	41,00











Kopalniško pohištvo

Kupaonski namještaj





Program: TARA

Umivalnik: liti marmor, vrata: MDF oplasčen s 3D folijo, barva: bela-mat (WH), craftwood (CW), umivaonik: lijevani mramor, vrata: MDF prevučeni s 3D folijom, boja: bijela-mat (WH), craftwood (CW)

kolpa-san

Model	Naziv in dimenzija izdelka Naziv i dimenzije produkta	Opis Opis	EAN koda EAN koda	Cena EUR Cijena EUR
OG 120, 100, 90, 80, 60 -LED, IR, DIM, CCT, C				
	OG 120 -LED, IR, DIM, CCT, C 1200 x 700 x 40	ogl. z integ. LED svetilko, senzor. stikalo (IR), regulator inten. sv. (DIM), CCT - sprememba barve svetlobe (toplo-hladno bela) in uro (C) / ogledalo sa integ. LED svjetlom, senzor. prekidač (IR), regulator intenzivnosti svjetla (DIM), CCT - regulator boje svjetlosti (toplo-hladno bijela) i satom (C)	3838987 580157	340,00
	OG 100 -LED, IR, DIM, CCT, C 1000 x 700 x 40		3838987 580140	313,00
	OG 90 -LED, IR, DIM, CCT, C 900 x 700 x 40		3838987 580133	293,00
	OG 80 -LED, IR, DIM, CCT, C 800 x 700 x 40		3838987 580126	277,00
	OG 60 -LED, IR, DIM, CCT, C 600 x 700 x 40		3838987 580119	256,00
OG 100, 80, 60 -LED, T				
	OG 100 -LED, T 1000 x 700 x 20	ogledalo z integrirano ambientalno LED svetilko, senzorsko stikalo (T) ogledalo s integriranim ambientalnim LED svjetlom, senzorski prekidač (T) LED barva/boja - NEUTRAL WHITE	3838987 507260	311,00
	OG 80 -LED, T 800 x 700 x 20		3838987 507253	275,00
	OG 60 -LED, T 600 x 700 x 20		3838987 507246	254,00
OG 120, 100, 90, 80, 70, 60				
	OG 120 1200 x 700 x 20	ogledalo, pravokotno ogledalo, pravokutno	3838987 546443	113,00
	OG 100 1000 x 700 x 20		3838987 547402	99,00
	OG 90 900 x 700 x 20		3838987 547396	92,00
	OG 80 800 x 700 x 20		3838987 546436	87,00
	OG 70 700 x 700 x 20		3838987 546412	80,00
	OG 60 600 x 700 x 20		3838987 547389	76,00
POLICA OG 120, 100, 90, 80, 70, 60				
 	POLICA OG 120 WH 1205 x 22 x 120	polica za pravokotno ogledalo s konzolo polica za pravokutnu ogledalo s konzolom	3838987 546474	68,00
	POLICA OG 100 WH 1005 x 22 x 120		3838987 547464	61,00
	POLICA OG 90 WH 905 x 22 x 120		3838987 547457	58,00
	POLICA OG 80 WH 805 x 22 x 120		3838987 547440	54,00
	POLICA OG 70 WH 705 x 22 x 120		3838987 547433	49,00
	POLICA OG 60 WH 605 x 22 x 120		3838987 547426	47,00
KOZMETIČNO OGLEDALO				
	KOZMETIČNO OGLEDALO	ogledalo, okroglo ogledalo, okruglo	3838987 546535	116,00







Model	Naziv in dimenzija izdelka Naziv i dimenzije produkta	Opis Opis	EAN koda EAN koda	Cena EUR Cijena EUR
TO 110 -LED, SW, S				
	TO 110 WH -LED, SW, S	toaletna omarica z LED svetilko, stikalo (SW), vtičnica (S) toaletni ormarič s LED svjetlom, prekidač (SW), utičnica (S) LED barva/boja - NEUTRAL WHITE	3838987 507468	558,00
	TO 110 CW -LED, SW, S		3838987 547778	558,00
1104 x 718 x 170				
TO 90 -LED, SW, S				
	TO 90 WH -LED, SW, S	toaletna omarica z LED svetilko, stikalo (SW), vtičnica (S) toaletni ormarič s LED svjetlom, prekidač (SW), utičnica (S) LED barva/boja - NEUTRAL WHITE	3838987 507437	473,00
	TO 90 CW -LED, SW, S		3838987 547761	473,00
904 x 718 x 170				
TO 70 -LED, SW, S				
	TO 70 WH -LED, SW, S	toaletna omarica z LED svetilko, stikalo (SW), vtičnica (S) toaletni ormarič s LED svjetlom, prekidač (SW), utičnica (S) LED barva/boja - NEUTRAL WHITE	3838987 528425	371,00
	TO 70 CW -LED, SW, S		3838987 547754	371,00
704 x 718 x 170				
OUT 110				
	OUT 110 WH	omariča z umivalnikom ormarič s umivaonikom Priložen spodnji del sifona/ Uključen donji dio sifona	3838987 528395	723,00
	OUT 110 CW		3838987 547549	723,00
1110 x 495 x 450				
OUT 90				
	OUT 90 WH	omariča z umivalnikom ormarič s umivaonikom Priložen spodnji del sifona/ Uključen donji dio sifona	3838987 528371	639,00
	OUT 90 CW		3838987 547532	639,00
910 x 495 x 450				

Kopalniško pohištvo
 Kupaonski namještaj

Program: TARA

 Umivalnik: liti marmor, vrata: MDF oplasčen s 3D folijo, barva: bela-mat (WH),
 craftwood (CW), umivaonik: lijevani mramor, vrata: MDF prevučeni s 3D folijom, boja:
 bijela-mat (WH), craftwood (CW)







kolpa-san

Model	Naziv in dimenzija izdelka Naziv i dimenzije produkta	Opis Opis	EAN koda EAN koda	Cena EUR Cijena EUR
OUT 70				
	OUT 70 WH	omara z umivalnikom ormarič s umivaonikom Priložen spodnji del sifona/ Uključen donji dio sifona	3838987 528340	581,00
	OUT 70 CW		3838987 547525	581,00
	710 x 495 x 450			
T 1501				
	T 1501 WH	omara z vrati in predaloma ormarič sa vratima i ladicama	3838987 528494	372,00
	T 1501 CW		3838987 547570	372,00
	450 x 1500 x 320			
T 712/20				
	T 712/20 WH	omara z vrati ormarič sa vratima	3838987 528517	126,00
	T 712/20 CW		3838987 547563	126,00
	450 x 712 x 200			
OT 45				
	OT 45 WH	omara s predaloma ormarič sa ladicama	3838987 528531	403,00
	OT 45 CW		3838987 547556	403,00
	456 x 480 x 321			
ORGANIZATOR PREDALA				
	ORGANIZATOR PREDALA ZG.350	za zgornji predal za gornju ladicu	3838987 529477	42,00









Kopalniško pohištvo
Kupaonski namještaj**Program: TARA**Umivalnik: liti marmor, vrata: MDF oplasčen s 3D folijo, barva: bela-mat (WH),
craftwood (CW), umivaonik: lijevani mramor, vrata: MDF prevučeni s 3D folijom, boja:
bijela-mat (WH), craftwood (CW)

kolpa-san®







Model	Naziv in dimenzija izdelka Naziv i dimenzije produkta	Opis Opis	EAN koda EAN koda	Cena EUR Cijena EUR
LUČ 700, 500 BL -LED				
 	LUČ 700 BL -LED L=700	Svetilka (LED) za OG Svjetlo (LED) za OG LED barva/boja - NEUTRAL WHITE	3838987 547518	100,00
	LUČ 500 BL -LED L=500		3838987 546542	92,00
LUČ 300 -LED				
 	LUČ 300 -LED L = 300	svetilka (LED) brez vtičnice in stikala za OG svjetlo (LED) bez utičnice i prekidača za OG LED barva/boja - NEUTRAL WHITE	3838987 509974	56,00
NOGICE POHIŠTVA				
 	NOGICE POHIŠTVA, h=40 cm	nogice za ormarice, h=40 cm, (par) noge za ormariče, h=40 cm, (par)	3838987 505921	65,00

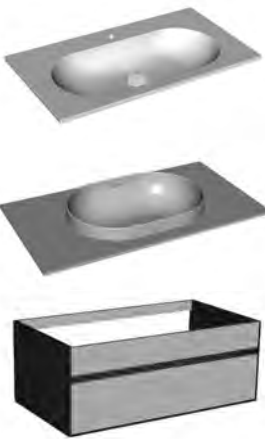
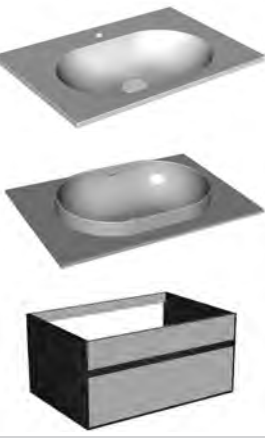
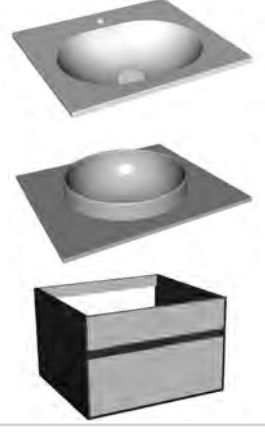









Model	Naziv in dimenzija izdelka Naziv i dimenzije produkta	Opis Opis	EAN koda EAN koda	Cena EUR Cijena EUR
OG 100, 80, 60 -LED, T				
	OG 100 -LED, T 1000 x 700 x 20	ogledalo z integrirano ambientalno LED svetilko, senzorsko stikalo (T) ogledalo s integriranim ambientalnim LED svetlom, senzorski prekidač (T) LED barva/boja - NEUTRAL WHITE	3838987 507260	311,00
	OG 80 -LED, T 800 x 700 x 20		3838987 507253	275,00
	OG 60 -LED, T 600 x 700 x 20		3838987 507246	254,00
OG 100, 90, 80, 60 -LED, IR, DIM, CCT, C				
	OG 100 -LED, IR, DIM, CCT, C 1000 x 700 x 40	ogl. z integ. LED svetilko, senzor. stikalo (IR), regulator inten. sv. (DIM), CCT - sprememba barve svetlobe (toplo-hladno bela) in uro (C) / ogledalo sa integ. LED svijetlom, senzor. prekidač (IR), regulator intenzivnosti svjetla (DIM), CCT - regulator boje svjetlosti (toplo-hladno bijela) i satom (C)	3838987 580140	313,00
	OG 90 -LED, IR, DIM, CCT, C 900 x 700 x 40		3838987 580133	293,00
	OG 80 -LED, IR, DIM, CCT, C 800 x 700 x 40		3838987 580126	277,00
	OG 60 -LED, IR, DIM, CCT, C 600 x 700 x 40		3838987 580119	256,00
OG 100, 80, 60				
	OG 100 1000 x 700 x 20	ogledalo, pravokotno ogledalo, pravokutno	3838987 547402	99,00
	OG 80 800 x 700 x 20		3838987 546436	87,00
	OG 60 600 x 700 x 20		3838987 547389	76,00
POLICA OG 100, 80, 60				
	POLICA OG 100 WH 1005 x 22 x 120	polica za pravokotno ogledalo s konzolo polica za pravokutnu ogledalo s konzolom	3838987 547464	61,00
	POLICA OG 80 WH 805 x 22 x 120		3838987 547440	54,00
	POLICA OG 60 WH 605 x 22 x 120		3838987 547426	47,00
KOZMETIČNO OGLEDALO				
	KOZMETIČNO OGLEDALO Ø 25	povečevalno ogledalo, okroglo uvečavajuće ogledalo, okruglo	3838987 546535	116,00
TOD, TO 100 -LED, SW, S				
	TOD 100 BEIGE -LED, SW, S	toaletna omarica z LED svetilko, stikalo (SW), vtičnica (S) toaletni ormarič s LED svijetlom, prekidač (SW), utičnica (S) LED barva/boja - NEUTRAL WHITE	3838987 510826	554,00
	TO 100 BL -LED, SW, S 1000 x 690 x 130		3838987 528876	554,00
TOD, TO 80 -LED, SW, S				
	TOD 80 BEIGE -LED, SW, S	toaletna omarica z LED svetilko, stikalo (SW), vtičnica (S) toaletni ormarič s LED svijetlom, prekidač (SW), utičnica (S) LED barva/boja - NEUTRAL WHITE	3838987 528845	468,00
	TO 80 BL -LED, SW, S 800 x 690 x 130		3838987 528869	468,00
www.kolpa.si		www.kolpa.hr		241





Model	Naziv in dimenzija izdelka Naziv i dimenzije produkta	Opis Opis	EAN koda EAN koda	Cena EUR Cijena EUR
TOD, TO 60 -LED, SW, S				
	TOD 60 BEIGE -LED, SW, S	toaletna omarica z LED svetilko, stikalo (SW), vtičnica (S) toaletni ormarič s LED svjetlom, prekidač (SW), utičnica (S) LED barva/boja - NEUTRAL WHITE	3838987 528838	370,00
	TO 60 BL -LED, SW, S		3838987 528852	370,00
600 x 690 x 130				
0UD 100				
	UD 100 /LM	umivalnik iz litega marmorja umivaonik od lijevanog mramora	3838987 528920	238,00
	UD 100 /KER	keramični umivalnik vgrajen na Kerrock odlagalni površini keramički umivaonik ugrađen na površini za odlaganje od Kerrocka	3838987 528951	288,00
	Ima izvrtino za armaturo/ ima otvor za armaturo			
OD 100 BEIGE / WH	podumivalniška omarica s predalom element ispod umivaonika s ladicom	3838987 510819	418,00	
OD 100 BL / WH		3838987 528821	418,00	
990 x 432 x 535				
0UD 80				
	UD 80 /LM	umivalnik iz litega marmorja umivaonik od lijevanog mramora	3838987 528913	215,00
	UD 80 /KER	keramični umivalnik vgrajen na Kerrock odlagalni površini keramički umivaonik ugrađen na površini za odlaganje od Kerrocka	3838987 528944	257,00
	Ima izvrtino za armaturo/ ima otvor za armaturo			
OD 80 BEIGE / WH	podumivalniška omarica s predalom element ispod umivaonika s ladicom	3838987 528791	378,00	
OD 80 BL / WH		3838987 528814	378,00	
790 x 432 x 535				
0UD 60				
	UD 60 /LM	umivalnik iz litega marmorja umivaonik od lijevanog mramora	3838987 528906	193,00
	UD 60 /KER	keramični umivalnik vgrajen na Kerrock odlagalni površini keramički umivaonik ugrađen na površini za odlaganje od Kerrocka	3838987 528937	226,00
OD 60 BEIGE / WH	podumivalniška omarica s predalom element ispod umivaonika s ladicom	3838987 528784	334,00	
OD 60 BL / WH		3838987 528807	334,00	
590 x 432 x 535				
242	www.kolpa.hr	www.kolpa.si		

Model	Naziv in dimenzija izdelka Naziv i dimenzije produkta	Opis Opis	EAN koda EAN koda	Cena EUR Cijena EUR
D 671				
	D 671 BEIGE/WH	omara z vrati in predalom ormarič sa vratima i ladicom	3838987 510833	348,00
	D 671 BL/WH		3838987 528883	348,00
460 x 680 x 325				
D 1453				
	D 1453 BEIGE/WH	omara z vrati ormarič sa vratima	3838987 510840	518,00
	D 1453 BL/WH		3838987 528890	518,00
450 x 1450 x 321				
LUČ 700, 500 BL -LED				
	LUČ 700 BL -LED L=700	Svetilka (LED) za OG Svjetlo (LED) za OG LED barva/boja - NEUTRAL WHITE	3838987 547518	100,00
	LUČ 500 BL -LED L=500		3838987 546542	92,00
LUČ 300 -LED				
	LUČ 300 -LED L= 300	svetilka (LED) brez vtičnice in stikala za OG svjetlo (LED) bez utičnice i prekidača za OG LED barva/boja - NEUTRAL WHITE	3838987 509974	56,00
ORGANIZATOR PREDALA				
	ORGANIZATOR PREDALA ZG.400	za zgornji predal za gornju ladicu	3838987 529460	47,00
NOGICE POHIŠTVA				
	NOGICE POHIŠTVA, h=40 cm	nogice za omarice, h=40 cm, (par) noge za ormariče, h=40 cm, (par)	3838987 505921	65,00



Model	Naziv in dimenzija izdelka Naziv i dimenzije produkta	Opis Opis	EAN koda EAN koda	Cena EUR Cijena EUR
OG 100, 90, 80, 60 -LED, IR, DIM, CCT, C				
	OG 100 -LED, IR, DIM, CCT, C 1000 x 700 x 40 OG 90 -LED, IR, DIM, CCT, C 900 x 700 x 40 OG 80 -LED, IR, DIM, CCT, C 800 x 700 x 40 OG 60 -LED, IR, DIM, CCT, C 600 x 700 x 40	ogl. z integ. LED svetilko, senzor. stikalo (IR), regulator inten. sv. (DIM), CCT - sprememba barve svetlobe (toplo-hladno bela) in uro (C) / ogledalo sa integ. LED svjetlom, senzor. prekidač (IR), regulator intenzivnosti svjetla (DIM), CCT - regulator boje svjetlosti (toplo-hladno bijela) i satom (C)	3838987 580140 3838987 580133 3838987 580126 3838987 580119	313,00 293,00 277,00 256,00
OG 100, 80, 60 -LED, T				
	OG 100 -LED, T 1000 x 700 x 20 OG 80 -LED, T 800 x 700 x 20 OG 60 -LED, T 600 x 700 x 20	ogledalo z integrirano ambientalno LED svetilko, senzorsko stikalo (T) ogledalo s integriranim ambientalnim LED svjetlom, senzorski prekidač (T) LED barva/boja - NEUTRAL WHITE	3838987 507260 3838987 507253 3838987 507246	311,00 275,00 254,00
OG 100, 80, 60				
	OG 100 1000 x 700 x 20 OG 80 800 x 700 x 20 OG 60 600 x 700 x 20	ogledalo, pravokotno ogledalo, pravokutno	3838987 547402 3838987 546436 3838987 547389	99,00 87,00 76,00
POLICA OG 100, 80, 60				
 	POLICA OG 100 WH 1005 x 22 x 120 POLICA OG 80 WH 805 x 22 x 120 POLICA OG 60 WH 605 x 22 x 120	polica za pravokotno ogledalo s konzolo polica za pravokutnu ogledalo s konzolom	3838987 547464 3838987 547440 3838987 547426	61,00 54,00 47,00
KOZMETIČNO OGLEDALO				
	KOZMETIČNO OGLEDALO Ø 25	povečevalno ogledalo, okroglo uvečavajuće ogledalo, okruglo	3838987 546535	116,00



Model	Naziv in dimenzija izdelka Naziv i dimenzije produkta	Opis Opis	EAN koda EAN koda	Cena EUR Cijena EUR
T00 100 -LED, SW, S				
	T00 100 WH -LED, SW, S	toaletna omarica z LED svetilko, stikalo (SW), vtičnica (S) toaletni ormarič s LED svetlom, prekidač (SW), utičnica (S) LED barva/boja - NEUTRAL WHITE	3838987 508281	406,00
	T00 100 ACACIA LIGHT -LED, SW, S		3838987 508298	406,00
	T00 100 HACIENDA BL. -LED, SW, S		3838987 508304	406,00
	1000 x 647 x 149			
T00 80 -LED, SW, S				
	T00 80 WH -LED, SW, S	toaletna omarica z LED svetilko, stikalo (SW), vtičnica (S) toaletni ormarič s LED svetlom, prekidač (SW), utičnica (S) LED barva/boja - NEUTRAL WHITE	3838987 508250	366,00
	T00 80 ACACIA LIGHT -LED, SW, S		3838987 508267	366,00
	T00 80 HACIENDA BL. -LED, SW, S		3838987 508274	366,00
	800 x 647 x 149			
T00 60 -LED, SW, S				
	T00 60 WH -LED, SW, S	toaletna omarica z LED svetilko, stikalo (SW), vtičnica (S) toaletni ormarič s LED svetlom, prekidač (SW), utičnica (S) LED barva/boja - NEUTRAL WHITE	3838987 508229	339,00
	T00 60 ACACIA LIGHT -LED, SW, S		3838987 508236	339,00
	T00 60 HACIENDA BL. -LED, SW, S		3838987 508243	339,00
	600 x 647 x 149			
OOU 105				
	OOU 105 WH	omariča z umivalnikom omarič s umivaonikom	3838987 507215	643,00
	OOU 105 ACACIA LIGHT		3838987 507222	643,00
	OOU 105 HACIENDA BL.		3838987 507239	643,00
	1055 x 651 x 460			
OOU 80				
	OOU 80 WH	omariča z umivalnikom ormarič s umivaonikom	3838987 506577	523,00
	OOU 80 ACACIA LIGHT		3838987 507192	523,00
	OOU 80 HACIENDA BL.		3838987 507208	523,00
	800 x 651 x 460			









Kopalniško pohištvo

Kupaonski namještaj





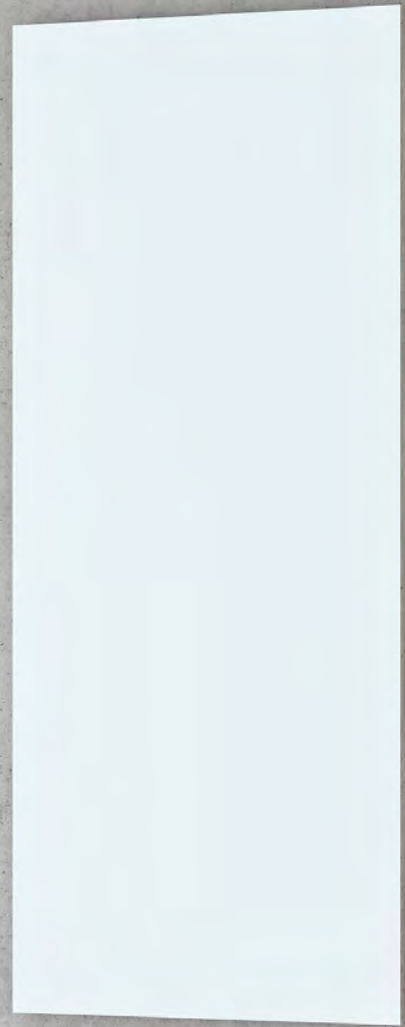
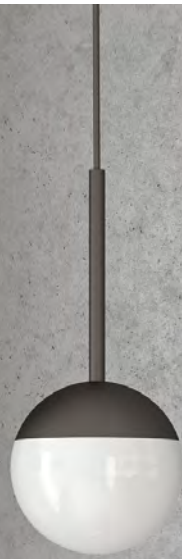

Program: OXANA

Umivalnik: keramični, vrata: MDF oplaščen, PVC folija, barva: bela-mat (WH), svetla akacija (ACACIA LIGHT), temni hrast (HACIENDA BL.) umivaonik: keramički, vrata: MDF prevučeni, PVC folija, boja: bijela-mat (WH), svjetli bagrem (ACACIA LIGHT), tamni hrast (HACIENDA BL.)









kolpa-san®

Model	Naziv in dimenzija izdelka Naziv i dimenzije produkta	Opis Opis	EAN koda EAN koda	Cena EUR Cijena EUR
OUO 60				
	OUO 60 WH	omarica z umivalnikom ormarič s umivaonikom	3838987 507161	455,00
	OUO 60 ACACIA LIGHT		3838987 507178	455,00
	OUO 60 HACIENDA BL.		3838987 507185	455,00
	605 x 651 x 460			
O 1752				
	O 1752 WH	omarica z vrati ormarič sa vratima	3838987 506584	275,00
	O 1752 ACACIA LIGHT		3838987 507307	275,00
	O 1752 HACIENDA BL.		3838987 507314	275,00
	400 x 1753 x 322			
O 953				
	O 953 WH	omarica z vrati ormarič sa vratima	3838987 507321	246,00
	O 953 ACACIA LIGHT		3838987 507338	246,00
	O 953 HACIENDA BL.		3838987 507345	246,00
	406 x 954 x 325			
LUČ 700, 500 BL -LED				
	LUČ 700 BL -LED	Svetilka (LED) za OG Svjetlo (LED) za OG LED barva/boja - NEUTRAL WHITE	3838987 547518	100,00
	LUČ 500 BL -LED		3838987 546542	92,00
LUČ 300 -LED				
	LUČ 300 -LED	svetilka (LED) brez vtičnice in stikala za OG svjetlo (LED) bez utičnice i prekidača za OG LED barva/boja - NEUTRAL WHITE	3838987 509974	56,00
	L = 300			
ORGANIZATOR PREDALA				
	ORGANIZATOR PREDALA ZG.350	za zgornji predal za gornju ladicu	3838987 529477	42,00
	ORGANIZATOR PREDALA SP.350	za spodnji predal za donju ladicu	3838987 529491	45,00
	KOZMETIČNI KOŠ	za spodnji predal za donju ladicu	3838987 529507	21,00
	174 x 232 x 174			
NOGICE POHIŠTVA				
	NOGICE POHIŠTVA, h=20 cm	nogice za omarice, h=20 cm, (par) noge za ormariče, h=20 cm, (par)	3838987 505914	41,00



Model	Naziv in dimenzija izdelka Naziv i dimenzije produkta	Opis Opis	EAN koda EAN koda	Cena EUR Cijena EUR
OG 60 -LED, IR, DIM, CCT, C				
	OG 60 -LED, IR, DIM, CCT, C 600 x 700 x 20	ogl. z integ. LED svetilko, senzor. stikalo (IR), regulator inten. sv. (DIM), CCT - sprememba barve svetlobe (toplo-hladno bela) in uro (C) / ogledalo sa integ. LED svijetlom, senzor. prekidač (IR), regulator intenzivnosti svjetla (DIM), CCT - regulator boje svjetlosti (toplo-hladno bijela) i satom (C)	3838987 580119	256,00
OG 60 -LED, T				
	OG 60 -LED, T 600 x 700 x 20	ogledalo z integrirano ambientalno LED svetilko, senzorsko stikalo (T) ogledalo s integriranim ambientalnim LED svijetlom, senzorski prekidač (T) LED barva/boja - NEUTRAL WHITE	3838987 507246	254,00
OG 60, 50				
	OG 60 600 x 700 x 20 OG 50 500 x 700 x 20	ogledalo, pravokotno ogledalo, pravokutno	3838987 547389 3838987 546405	76,00 62,00
POLICA OG 60, 50				
 	POLICA OG 60 WH 605 x 22 x 120 POLICA OG 50 WH 505 x 22 x 120	polica za pravokotno ogledalo s konzolo polica za pravokutnu ogledalo s konzolom	3838987 547426 3838987 546467	47,00 44,00
KOZMETIČNO OGLEDALO				
	KOZMETIČNO OGLEDALO Ø 25	povečevalno ogledalo, okroglo uvečavajuće ogledalo, okruglo	3838987 546535	116,00
OGK 40				
	OGK 40/90 WH OGK 40/90 CW 400 x 900 x 21	ogledalo ogledalo	3838987 503101 3838987 547587	72,00 72,00



Model	Naziv in dimenzija izdelka Naziv i dimenzije produkta	Opis Opis	EAN koda EAN koda	Cena EUR Cijena EUR		
OUK 40, 50, 60						
	OUK 40 WH	406 x 510 x 253	omarica z umivalnikom ormarič s umivaonikom	3838987 502821	217,00	
	OUK 40 CW			3838987 547594	217,00	
	OUK 50 WH			506 x 510 x 253	3838987 538783	238,00
	OUK 50 CW				3838987 547624	238,00
	OUK 60 WH	606 x 510 x 303		3838987 538806	268,00	
	OUK 60 CW			3838987 547655	268,00	
	OUK 40 -L WH	406 x 510 x 253	omarica z umivalnikom ormarič s umivaonikom - leva izvedba - lijeva varijanta	3838987 529125	221,00	
	OUK 40 -L CW			3838987 547600	221,00	
	OUK 50 -L WH	506 x 510 x 253		3838987 568087	243,00	
	OUK 50 -L CW			3838987 547631	243,00	
	OUK 60 -L WH	606 x 510 x 303		3838987 561217	266,00	
	OUK 60 -L CW			3838987 547662	266,00	
	OUK 40 -D WH	406 x 510 x 253	omarica z umivalnikom ormarič s umivaonikom - desna izvedba - desna varijanta	3838987 529132	221,00	
	OUK 40 -D CW			3838987 547617	221,00	
	OUK 50 -D WH	506 x 510 x 253		3838987 561156	243,00	
	OUK 50 -D CW			3838987 547648	243,00	
	OUK 60 -D WH	606 x 510 x 303		3838987 561194	266,00	
	OUK 60 -D CW			3838987 547679	266,00	
LUČ 300 -LED						
 	LUČ 300 -LED	L = 300	svetilka (LED) brez vtičnice in stikala svjetlo (LED) bez utičnice i prekidača LED barva/boja - NEUTRAL WHITE	3838987 509974	56,00	
LUČ 500 BL -LED						
 	LUČ 500 BL -LED	L = 500	Svetilka (LED) za OGE in TOE Svjetlo (LED) za OGE i TOE LED barva/boja - NEUTRAL WHITE	3838987 546542	92,00	



Kopalniško pohištvo
Kupaonski namještaj









Kopalniško pohištvo
Kupaonski namještaj

Program: EVELIN

Umivalnik: keramični, vrata: oplemenitena iverna plošča, barva: bela sijaj (WH), antracit (ANT), hrast (OAK) / umivaonik: keramički, vrata: oplemenitena iverna plošča, boja: bijela sijaj (WH), antracit (ANT), hrast (OAK)

kolpa-san

Model	Naziv in dimenzija izdelka Naziv i dimenzije produkta	Opis Opis	EAN koda EAN koda	Cena EUR Cijena EUR
OGE 55, 65, 80				
	OGE 55 WH	ogledalo s polico	3838987 561989	72,00
	OGE 55 GRAY 550 x 700 x 140	ogledalo sa policom	3838987 561996	72,00
	OGE 65 WH	ogledalo s polico	3838987 573920	77,00
	OGE 65 GRAY 650 x 700 x 140	ogledalo sa policom	3838987 573937	77,00
	OGE 80 WH	ogledalo s polico	3838987 573944	83,00
	OGE 80 GRAY 800 x 700 x 140	ogledalo sa policom	3838987 573951	83,00
TOE 55, 65, 80				
	TOE 55 WH	toaletna omarica	3838987 562009	105,00
	TOE 55 GRAY 550 x 700 x 140	toaletni ormarič	3838987 562016	105,00
	TOE 65 WH	toaletna omarica	3838987 573968	110,00
	TOE 65 GRAY 650 x 700 x 140	toaletni ormarič	3838987 573975	110,00
	TOE 80 WH	toaletna omarica	3838987 573982	124,00
	TOE 80 GRAY 800 x 700 x 140	toaletni ormarič	3838987 573999	124,00
OUE 55, 65, 80				
	OUE 55 WH	omarca z umivalnikom	3838987 562023	203,00
	OUE 55 GRAY/ANT	ormarič s umivaonikom	3838987 562030	203,00
	OUE 55 GRAY/OAK 555 x 645 x 460		3838987 562047	203,00
	OUE 65 WH	omarca z umivalnikom	3838987 573807	226,00
	OUE 65 GRAY/ANT	ormarič s umivaonikom	3838987 573814	226,00
	OUE 65 GRAY/OAK 655 x 645 x 460		3838987 573821	226,00
	OUE 80 WH	omarca z umivalnikom	3838987 573838	250,00
	OUE 80 GRAY/ANT	ormarič s umivaonikom	3838987 573845	250,00
	OUE 80 GRAY/OAK 800 x 645 x 460		3838987 573852	250,00
OUE 55 II, 65 II, 80 II				
	OUE 55 II WH	omarca z umivalnikom	3838987 562054	208,00
	OUE 55 II GRAY/ANT	ormarič s umivaonikom	3838987 562061	208,00
	OUE 55 II GRAY/OAK 555 x 645 x 460		3838987 562078	208,00
	OUE 65 II WH	omarca z umivalnikom	3838987 573869	229,00
	OUE 65 II GRAY/ANT	ormarič s umivaonikom	3838987 573876	229,00
	OUE 65 II GRAY/OAK 655 x 645 x 460		3838987 573883	229,00
	OUE 80 II WH	omarca z umivalnikom	3838987 573890	254,00
	OUE 80 II GRAY/ANT	ormarič s umivaonikom	3838987 573906	254,00
	OUE 80 II GRAY/OAK 800 x 645 x 460		3838987 573913	254,00







Model	Naziv in dimenzija izdelka Naziv i dimenzije produkta	Opis Opis	EAN koda EAN koda	Cena EUR Cijena EUR
E 702 WH				
 	E 702 WH	omaraica z vrati in zaključno polico ormarič sa vratima i ukrasnim stropom	3838987 574033	89,00
	E 702 GRAY/ANT		3838987 574040	89,00
	E 702 GRAY/OAK		3838987 574057	89,00
	370 x 700 x 346			
E 1021				
 	E 1021 WH	omaraica z vrati in zaključno polico ormarič sa vratima i ukrasnim stropom	3838987 574002	152,00
	E 1021 GRAY/ANT		3838987 574019	152,00
	E 1021 GRAY/OAK		3838987 574026	152,00
	372 x 1020 x 353			
E 1702				
 	E 1702 WH	omaraica z vrati ormarič sa vratima	3838987 574064	151,00
	E 1702 GRAY/ANT		3838987 574071	151,00
	E 1702 GRAY/OAK		3838987 574088	151,00
	370 x 1700 x 346			
LUČ 700, 500 BL BOX -LED, SW, S				
 	LUČ 700 BL BOX -LED, SW, S L=700	Svetilka (LED), stikalo (SW), vtičnica (S), BOX za TOE / Svjetlo (LED), prekidač (SW), utičnica (S), BOX za TOE	3838987 546566	135,00
	LUČ 500 BL BOX -LED, SW, S L=500		3838987 546559	128,00
		LED barva/boja - NEUTRAL WHITE		
LUČ 700, 500 BL -LED				
 	LUČ 700 BL -LED	Svetilka (LED) za OGE in TOE Svjetlo (LED) za OGE i TOE	3838987 547518	100,00
	LUČ 500 BL -LED		3838987 546542	92,00
		LED barva/boja - NEUTRAL WHITE		

Kopalniško pohištvo
Kupaonski namještaj**Program: EVELIN**

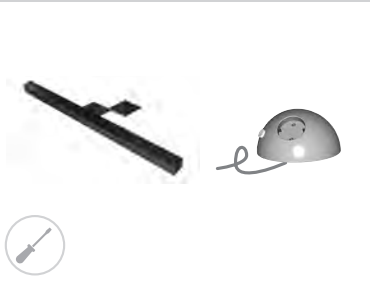
Umivalnik: keramični, vrata: oplemenitena iverna plošča, barva: bela sijaj (WH), antracit (ANT), hrast (OAK) / umivaonik: keramički, vrata: oplemenitena iverna ploča, boja: bijela sjaj (WH), antracit (ANT), hrast (OAK)

kolpa-san®

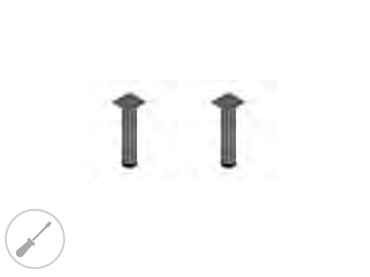
Model	Naziv in dimenzija izdelka Naziv i dimenzije produkta	Opis Opis	EAN koda EAN koda	Cena EUR Cijena EUR
LUČ 500 BOX -LED, SW, S				
	LUČ 500 BOX -LED, SW, S L = 500	svetilka (LED), stikalo (SW), vtičnica (S), BOX za toaletno omarico TOE/ svjetlo (LED), prekidač (SW), utičnica (S), BOX za toaletni ormarič TOE LED barva/boja - NEUTRAL WHITE	3838987 300298	122,00
LUČ 300 -LED				
	LUČ 300 -LED L = 300	svetilka (LED) brez vtičnice in stikala za TOE in OGE svjetlo (LED) bez utičnice i prekidača za TOE i OGE LED barva/boja - NEUTRAL WHITE	3838987 509974	56,00
KOZMETIČNO OGLEDALO				
	KOZMETIČNO OGLEDALO Ø 25	povečevalno ogledalo, okroglo uvečavajuće ogledalo, okruglo	3838987 546535	116,00
KOŠ ZA PERILO				
	KOŠ ZA PERILO 280 x 500 x 218	koš za perilo za omarice širine 35 cm koš za rublje za ormarič širine 35 cm	3838987 944270	37,00
NOGICE POHIŠTVA				
	NOGICE POHIŠTVA, h=20 cm	nogice za omarice, h=20 cm, (par) noge za ormariče, h=20 cm, (par)	3838987 505914	41,00











Kopalniško pohištvo

Kupaonski namještaj

Program: LANA

Umivalnik: keramični, vrata, obod: oplemenitena iverna plošča, barva: siva (GRAY), svetla akacija (ACACIA LIGHT) umivaonik: keramični, vrata, obod: oplemenitena iverna ploča, boja: siva (GRAY), svjetli bagrem (ACACIA LIGHT)

kolpa-san

Model	Naziv in dimenzija izdelka Naziv i dimenzije produkta	Opis Opis	EAN koda EAN koda	Cena EUR Cijena EUR
OGL 65, 80				
	OGL 65 GRAY	ogledalo s polico ogledalo sa policom	3838987 510864	81,00
	OGL 65 ACACIA LIGHT		3838987 529033	81,00
	650 x 700 x 140			
	OGL 80 GRAY	ogledalo s polico ogledalo sa policom	3838987 529026	90,00
OGL 80 ACACIA LIGHT	3838987 529040		90,00	
800 x 700 x 140				
TOL 65, 80				
	TOL 65 GRAY	toaletna omarica toaletni ormarič	3838987 529057	158,00
	TOL 65 ACACIA LIGHT		3838987 529071	158,00
	650 x 700 x 140			
	TOL 80 GRAY	toaletna omarica toaletni ormarič	3838987 529064	174,00
TOL 80 ACACIA LIGHT	3838987 510901		174,00	
800 x 700 x 140				
OUL 65, 80				
	OUL 65 GRAY	omarica z umivalnikom - vrata ormarič s umivaonikom - vrata	3838987 528999	251,00
	OUL 65 ACACIA LIGHT		3838987 529019	251,00
	650 x 570 x 495			
	OUL 80 GRAY	omarica z umivalnikom - vrata ormarič s umivaonikom - vrata	3838987 529002	285,00
OUL 80 ACACIA LIGHT	3838987 510895		285,00	
800 x 570 x 495				
OUL 65 II, 80 II				
	OUL 65 II GRAY	omarica z umivalnikom - predali ormarič s umivaonikom - ladice	3838987 510857	331,00
	OUL 65 II ACACIA LIGHT		3838987 528975	331,00
	650 x 570 x 495			
	OUL 80 II GRAY	omarica z umivalnikom - predali ormarič s umivaonikom - ladice	3838987 528968	371,00
OUL 80 II ACACIA LIGHT	3838987 528982		371,00	
800 x 570 x 495				
L 702/14				
	L 702/14 GRAY	omarica z vratni ormarič sa vratima	3838987 529095	87,00
	L 702/14 ACACIA LIGHT		3838987 510925	87,00
	400 x 700 x 136			





Model	Naziv in dimenzija izdelka Naziv i dimenzije produkta	Opis Opis	EAN koda EAN koda	Cena EUR Cijena EUR
L 872				
 	L 872 GRAY	omariča z vrati ormarič sa vratima	3838987 510888	138,00
	L 872 ACACIA LIGHT		3838987 529088	138,00
402 x 876 x 370				
L 1562				
 	L 1562 GRAY	omariča z vrati ormarič sa vratima	3838987 510871	214,00
	L 1562 ACACIA LIGHT		3838987 510918	214,00
400 x 1560 x 366				
LUČ 700, 500 BL BOX-LED, SW, S				
 	LUČ 700 BL BOX-LED, SW, S L=700	Svetilka (LED), stikalo (SW), vtičnica (S), BOX za TOL / Svjetlo (LED), prekidač (SW), utičnica (S), BOX za TOL LED barva/boja - NEUTRAL WHITE	3838987 546566	135,00
	LUČ 500 BL BOX-LED, SW, S L=500		3838987 546559	128,00
LUČ 700, 500 BL -LED				
 	LUČ 700 BL -LED L=700	Svetilka (LED) za TOL in OGL Svjetlo (LED) za TOL i OGL LED barva/boja - NEUTRAL WHITE	3838987 547518	100,00
	LUČ 500 BL -LED L=500		3838987 546542	92,00
LUČ 500 BOX-LED, SW, S				
 	LUČ 500 BOX-LED, SW, S L = 500	svetilka (LED), stikalo (SW), vtičnica (S), BOX za toaletno omaričo TOL / svjetlo (LED), prekidač (SW), utičnica (S), BOX za toaletni ormarič TOL LED barva/boja - NEUTRAL WHITE	3838987 300298	122,00





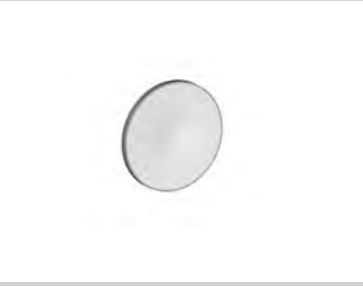

Kopalniško pohištvo
Kupaonski namještaj**Program: LANA**

Umivalnik: keramični, vrata, obod: oplemenitena iverna plošča, barva: siva (GRAY), svetla akacija (ACACIA LIGHT) umivaonik: keramički, vrata, obod: oplemenitena iverna ploča, boja: siva (GRAY), svjetli bagrem (ACACIA LIGHT)

kolpa-san®

Model	Naziv in dimenzija izdelka Naziv i dimenzije produkta	Opis Opis	EAN koda EAN koda	Cena EUR Cijena EUR
LUČ 300 -LED				
	LUČ 300 -LED L = 300	svetilka (LED) brez vtičnice in stikala za TOL in OGL svjetlo (LED) bez utičnice i prekidača za TOL i OGL LED barva/boja - NEUTRAL WHITE	3838987 509974	56,00
KOZMETIČNO OGLEDALO				
	KOZMETIČNO OGLEDALO Ø 25	povečevalno ogledalo, okroglo uvećavajuće ogledalo, okruglo	3838987 546535	116,00
KOŠ ZA PERILO				
	KOŠ ZA PERILO 280 x 500 x 218	koš za perilo za omarice širine 35 cm koš za rublje za ormarić širine 35 cm	3838987 944270	37,00



Model	Naziv in dimenzija izdelka Naziv i dimenzije produkta	Opis Opis	EAN koda EAN koda	Cena EUR Cijena EUR
OG Ø 150 -LED, IR, DIM				
	OG Ø 150 (Ø 120 + Ø 80) -LED, IR, DIM (2 ogledala /ogledala, 3 lučke/svjetla) 1500 x 1200 x 30	ogledalo z LED svetilko, senzorsko stikalo (IR), regulator intenzivnosti svetlobe (DIM) / ogledalo sa LED svjetlom, senzorski prekidač (IR), regulator intenzivnosti svjetla (DIM) LED barva/boja - NEUTRAL WHITE	3838987 546450	536,00
OG Ø 120, 100, 80 -LED, IR, DIM				
	OG Ø 120 -LED, IR, DIM (2 lučki/svjetla) OG Ø 100 -LED, IR, DIM OG Ø 80 -LED, IR, DIM	ogledalo z LED svetilko, senzorsko stikalo (IR), regulator intenzivnosti svetlobe (DIM) / ogledalo sa LED svjetlom, senzorski prekidač (IR), regulator intenzivnosti svjetla (DIM) LED barva/boja - NEUTRAL WHITE	3838987 573708 3838987 573692 3838987 573685	399,00 299,00 266,00
OG 100, 80, 60 -LED, T				
	OG 100 -LED, T 1000 x 700 x 20 OG 80 -LED, T 800 x 700 x 20 OG 60 -LED, T 600 x 700 x 20	ogledalo z integrirano ambientalno LED svetilko, senzorsko stikalo (T) ogledalo s integriranim ambientalnim LED svjetlom, senzorski prekidač (T) LED barva/boja - NEUTRAL WHITE	3838987 507260 3838987 507253 3838987 507246	311,00 275,00 254,00
OG 120, 100, 90, 80, 60 -LED, IR, DIM, CCT, C				
	OG 120 -LED, IR, DIM, CCT, C 1200 x 700 x 40 OG 100 -LED, IR, DIM, CCT, C 1000 x 700 x 40 OG 90 -LED, IR, DIM, CCT, C 900 x 700 x 40 OG 80 -LED, IR, DIM, CCT, C 800 x 700 x 40 OG 60 -LED, IR, DIM, CCT, C 600 x 700 x 40	ogl. z integ. LED svetilko, senzor. stikalo (IR), regulator inten. sv. (DIM), CCT - sprememba barve svetlobe (toplo-hladno bela) in uro (C) / ogledalo sa integ. LED svjetlom, senzor. prekidač (IR), regulator intenzivnosti svjetla (DIM), CCT - regulator boje svjetlosti (toplo-hladno bijela) i satom (C)	3838987 580157 3838987 580140 3838987 580133 3838987 580126 3838987 580119	340,00 313,00 293,00 277,00 256,00
OG 150, 120, 100, 90, 80, 70, 60, 50				
	OG 150 1500 x 700 x 20 OG 120 1200 x 700 x 20 OG 100 1000 x 700 x 20 OG 90 900 x 700 x 20 OG 80 800 x 700 x 20 OG 70 700 x 700 x 20 OG 60 600 x 700 x 20 OG 50 500 x 700 x 20	ogledalo, pravokotno ogledalo, pravokutno	3838987 547419 3838987 546443 3838987 547402 3838987 547396 3838987 546436 3838987 546412 3838987 547389 3838987 546405	129,00 113,00 99,00 92,00 87,00 80,00 76,00 62,00
POLICA OG 150, 120, 100, 90, 80, 70, 60, 50				
	POLICA OG 150 WH 1505 x 22 x 120 POLICA OG 120 WH 1205 x 22 x 120 POLICA OG 100 WH 1005 x 22 x 120 POLICA OG 90 WH 905 x 22 x 120 POLICA OG 80 WH 805 x 22 x 120 POLICA OG 70 WH 705 x 22 x 120 POLICA OG 60 WH 605 x 22 x 120 POLICA OG 50 WH 505 x 22 x 120	polica za pravokotno ogledalo s konzolo polica za pravokutnu ogledalo s konzolom	3838987 547471 3838987 546474 3838987 547464 3838987 547457 3838987 547440 3838987 547433 3838987 547426 3838987 546467	76,00 68,00 61,00 58,00 54,00 49,00 47,00 44,00
KOZMETIČNO OGLEDALO				
	KOZMETIČNO OGLEDALO Ø 25	povečevalno ogledalo, okroglo uvečavajuće ogledalo, okruglo	3838987 546535	116,00
260	www.kolpa.hr	www.kolpa.si		



Kopalniški dodatki Kupaonski dodaci

Pridržujemo si pravico do spremembe podatkov. Dimenzije so informativnega značaja.
Zadržavamo si pravo do izmjene podataka. Dimenzije su informativnog karaktera.





Slike so simbolične.
Slike su simbolične.





2

leti garancije
godina jamstva







Model	Naziv in dimenzija izdelka Naziv i dimenzije produkta	Opis Opis	EAN koda EAN koda	Cena EUR Cijena EUR
E0-01				
	E0-01 Dimenzija: 20 x 55 x 46	kljukasto obešalo kukasta vješalica	3838987 402008	24,00
E0-02				
	E0-02 Dimenzija: 69 x 105 x 97	nosilec s kozarcem držač s čašom	3838987 402015	42,00
E0-03				
	E0-03 Dimenzija: 100 x 35 x 112	nosilec s podstavkom za milo držač posudice za sapun	3838987 402022	42,00
E0-04				
	E0-04 Dimenzija: 194 x 20 x 109	košarica za milo košarica za sapun	3838987 402039	54,00
E0-05				
	E0-05 Dimenzija: 450 x 20 x 64	držalo za brisače – 450 držač ručnika	3838987 402046	73,00





Model	Naziv in dimenzija izdelka Naziv i dimenzije produkta	Opis Opis	EAN koda EAN koda	Cena EUR Cijena EUR
E0-06				
	E0-06 Dimenzija: 595 x 20 x 64	držalo za brisače – 600 držač ručnika	3838987 402053	79,00
E0-07				
	E0-07 Dimenzija: 595 x 20 x 120	dvojno držalo za brisače – 600 dvostruki držač ručnika	3838987 402060	88,00
E0-08				
	E0-08 Dimenzija: 170 x 20 x 64	nosilec toaletnega papirja držač toaletnog papira	3838987 402077	42,00
E0-09				
	E0-09 Dimenzija: 150 x 104 x 58	nosilec toaletnega papirja držač toaletnog papira	3838987 402084	45,00
E0-10				
	E0-10 Dimenzija: 92 x 372 x 119	wc garnitura (posodica + ščetka) wc garnitura (posudica + četkica)	3838987 402091	58,00

Model	Naziv in dimenzija izdelka Naziv i dimenzije produkta	Opis Opis	EAN koda EAN koda	Cena EUR Cijena EUR
KR-01				
	KR-01	kljukasto obešalo, krom kukasta vješalica, krom	3838987 402206	19,00
	KR-01B	kljukasto obešalo, black kukasta vješalica, black	3838987 402213	22,00
Dimenzija: 38 x 38 x 50				
KR-02				
	KR-02	nosilec s kozarcem, krom držač s čašom, krom	3838987 402220	27,00
	KR-02B	nosilec s kozarcem, black držač s čašom, black	3838987 402237	32,00
Dimenzija: 69 x 105 x 104				
KR-03				
	KR-03	nosilec s podstavkom za milo, krom držač s čašom, krom	3838987 402244	27,00
	KR-03B	nosilec s podstavkom za milo, black držač s čašom, black	3838987 402251	32,00
Dimenzija: 99 x 43 x 119				
KR-04				
	KR-04	držalo za brisače – 450, krom držač ručnika, krom	3838987 402268	35,00
	KR-04B	držalo za brisače – 450, black držač ručnika, black	3838987 402275	42,00
Dimenzija: 456 x 38 x 70				
KR-05				
	KR-05	držalo za brisače – 600, krom držač ručnika, krom	3838987 402282	43,00
	KR-05B	držalo za brisače – 600, black držač ručnika, black	3838987 402299	52,00
Dimenzija: 601 x 38 x 70				

Kopalniška galanterija
Kupaonska galanterija**Program: KRIOS**Kopalniška galanterija – krom, black (B)
Kupaonska galanterija – krom, black (B)kolpa-san[®]

Model	Naziv in dimenzija izdelka Naziv i dimenzije produkta	Opis Opis	EAN koda EAN koda	Cena EUR Cijena EUR
KR-06				
	KR-06	dvojno držalo za brisače – 600, krom dvostruki držač ručnika, krom	3838987 402305	59,00
	KR-06B Dimenzija: 601 x 38 x 116	dvojno držalo za brisače – 600, black dvostruki držač ručnika, black	3838987 402312	71,00
KR-07				
	KR-07	nosilec toaletnega papirja, krom držač toaletnog papira, krom	3838987 402329	27,00
	KR-07B Dimenzija: 158 x 38 x 70	nosilec toaletnega papirja, black držač toaletnog papira, black	3838987 402336	32,00
KR-08				
	KR-08	nosilec toaletnega papirja s pokrovom, krom držač toaletnog papira sa pokrovom, krom	3838987 402343	29,00
	KR-08B Dimenzija: 137 x 120 x 50	nosilec toaletnega papirja s pokrovom, black držač toaletnog papira sa pokrovom, black	3838987 402350	35,00
KR-09				
	KR-09	wc garnitura (posodica + ščetka), krom wc garnitura (posudica + četkica), krom	3838987 402367	46,00
	KR-09B Dimenzija: 92 x 370 x 126	wc garnitura (posodica + ščetka), black wc garnitura (posudica + četkica), black	3838987 402374	55,00

Kopalniški dodatki
Kupaonski dodaci

Model	Naziv in dimenzija izdelka Naziv i dimenzije produkta	Opis Opis	EAN koda EAN koda	Cena EUR Cijena EUR
RE-01				
	RE-01	kljukasto obešalo, krom kukasta vješalica, krom	3838987 402381	11,00
	RE-01B	kljukasto obešalo, black kukasta vješalica, black	3838987 402398	14,00
	Dimenzija: 52 x 52 x 70			
RE-02				
	RE-02	nosilec s kozarcem, krom držač s čašom, krom	3838987 402404	23,00
	RE-02B	nosilec s kozarcem, black držač s čašom, black	3838987 402411	27,00
	Dimenzija: 67 x 99 x 106			
RE-03				
	RE-03	nosilec s podstavkom za milo, krom držač s čašom, krom	3838987 402428	23,00
	RE-03B	nosilec s podstavkom za milo, black držač s čašom, black	3838987 402435	27,00
	Dimenzija: 110 x 55 x 127			
RE-04				
	RE-04	košarica za milo, krom košarica za sapun, krom	3838987 402442	26,00
	RE-04B	košarica za milo, black košarica za sapun, black	3838987 402459	31,00
	Dimenzija: 126 x 52 x 141			
RE-05				
	RE-05	držalo za brisače – 450, krom držač ručnika, krom	3838987 402466	29,00
	RE-05B	držalo za brisače – 450, black držač ručnika, black	3838987 402473	35,00
	Dimenzija: 463 x 52 x 70			





Kopalniška galanterija
 Kupaonska galanterija





Program: REA
Kopalniška galanterija – krom, black (B)
 Kupaonska galanterija – krom, black (B)





kolpa-san

Model	Naziv in dimenzija izdelka Naziv i dimenzije produkta	Opis Opis	EAN koda EAN koda	Cena EUR Cijena EUR
RE-06				
	RE-06	držalo za brisače – 600, krom držač ručnika, krom	3838987 402480	32,00
	RE-06B	držalo za brisače – 600, black držač ručnika, black	3838987 402497	38,00
Dimenzija: 613 x 52 x 70				
RE-07				
	RE-07	dvojno držalo za brisače – 600, krom dvostruki držač ručnika, krom	3838987 402503	43,00
	RE-07B	dvojno držalo za brisače – 600, black dvostruki držač ručnika, black	3838987 402510	52,00
Dimenzija: 613 x 52 x 118				
RE-08				
	RE-08	nosilec toaletnega papirja, krom držač toaletnog papira, krom	3838987 402527	22,00
	RE-08B	nosilec toaletnega papirja, black držač toaletnog papira, black	3838987 402534	26,00
Dimenzija: 156 x 52 x 91				
RE-09				
	RE-09	nosilec toaletnega papirja s pokrovom, krom držač toaletnog papira sa pokrovom, krom	3838987 402541	25,00
	RE-09B	nosilec toaletnega papirja s pokrovom, black držač toaletnog papira sa pokrovom, black	3838987 402558	30,00
Dimenzija: 137 x 159 x 63				
RE-10				
	RE-10	wc garnitura (posodica + ščetka), krom wc garnitura (posudica + četkica), krom	3838987 402565	37,00
	RE-10B	wc garnitura (posodica + ščetka), black wc garnitura (posudica + četkica), black	3838987 402572	44,00
Dimenzija: 115 x 370 x 144				





Kopalniški dodatki
 Kupaonski dodaci



Model	Naziv in dimenzija izdelka Naziv i dimenzije produkta	Opis Opis	EAN koda EAN koda	Cena EUR Cijena EUR
EL-01				
	EL-01 Dimenzija: 363 x 174 x 42	gibljivo držalo za brisače, dvojno fleksibilni dvostruki držač ručnika	3838987 402589	36,00
EL-02				
	EL-02 Dimenzija: 138 x 30 x 28	kljukasto obešalo (2 kljukici) kukasta vješalica (2 kukice)	3838987 402596	16,00
EL-03				
	EL-03 Dimenzija: 198 x 30 x 28	kljukasto obešalo (3 kljukice) kukasta vješalica (3 kuke)	3838987 402602	19,00
EL-04				
	EL-04 Dimenzija: 258 x 30 x 28	kljukasto obešalo (4 kljukice) kukasta vješalica (4 kuke)	3838987 402619	25,00
EL-05				
	EL-05 Dimenzija: 318 x 30 x 28	kljukasto obešalo (5 kljukic) kukasta vješalica (5 kuka)	3838987 402626	31,00

Model	Naziv in dimenzija izdelka Naziv i dimenzije produkta	Opis Opis	EAN koda EAN koda	Cena EUR Cijena EUR
EL-06				
	EL-06 Dimenzija: 378 x30 x 30	kljukasto obešalo (6 kljukic) kukasta vješalica (6 kuka)	3838987 402633	34,00
EL-07				
	EL-07 Dimenzija: 613 x 150 x 228	polica z držalom za brisače držač ručnika	3838987 402640	84,00
EL-08				
	EL-08 Dimenzija: 615 x 190 x 259	polica z držalom za brisače, zložljiva držač ručnika, sklopivi	3838987 402657	113,00
EL-09				
	EL-09 Dimenzija: 300 x 700 x 223	dvojna viseča košarica za tuš kabino dvostruka viseća košarica za tuš kabinu	3838987 402664	136,00
EL-10				
	EL-10 Dimenzija: 202 x 383 x 202	dvojna kotna košarica za tuš kabino dvostruka kutna košarica za tuš kabinu	3838987 402671	82,00

Model	Naziv in dimenzija izdelka Naziv i dimenzije produkta	Opis Opis	EAN koda EAN koda	Cena EUR Cijena EUR
EL-11				
	EL-11 Dimenzija: 300 x 82 x 145	stenska košarica za tuš kabino zidna košarica za tuš kabinu	3838987 402688	44,00
EL-12				
	EL-12 Dimenzija: 210 x 76 x 210	kotna košarica za tuš kabino kutna košarica za tuš kabinu	3838987 402695	38,00
EL-13				
	EL-13 Dimenzija: 400 x 80 x 50	oprijem - 40 cm rukohvat - 40 cm	3838987 402701	35,00
EL-14				
	EL-14 Dimenzija: 403 x 215 x 87	Kotni oprijem – 130 ° Kutni rukohvat	3838987 402718	44,00
EL-15				
	EL-15 Dimenzija: 82 x 386	wc garnitura-samostoječa (posodica + ščetka) wc garnitura-samostoječa (posudica + četkica)	3838987 402725	61,00





Model	Naziv in dimenzija izdelka Naziv i dimenzije produkta	Opis Opis	EAN koda EAN koda	Cena EUR Cijena EUR
EL-16				
	EL-16 Dimenzija: 248 x 38 x 152	Brisalec stekla Brisač stakla	3838987 402732	19,00
EL-17				
	EL-17	obešalo za brisače, za na steklo tuš kabine, krom vješalica za ručnike, za na staklo tuš kabine, krom	3838987 402107	17,00
	EL-17B Dimenzija: 40 x 25 x 43	obešalo za brisače, za na steklo tuš kabine, black vješalica za ručnike, za na staklo tuš kabine, black	3838987 402114	20,00

Kopalniška galanterija Kupaonska galanterija	Program: Kopalniški sedeži		Kopalniški sedeži Kupaonska sijedala	kolpa-san®
Model	Naziv in dimenzija izdelka Naziv i dimenzije produkta	Opis Opis	EAN koda EAN koda	Cena EUR Cijena EUR
KS				
	KS	kopalniški stolček, h=38 cm, prenosni kupaonska stolica, h=38 cm, prijenosni	3838987 950608	59,00
SKK				
	SKK	sedež za kopalno kad sjedalo za kupaonsku kadu BETTY 170, 160, 150, 140, 130, 120, EVELIN 140, 150, 160, 170, ELEKTRA 160, 170, FIGARO 150, 170, MINI 100, TAMIA 170, 160, 150, 140 (Nosilnost do 130 kg)	3838987 950943	106,00
SDL				
	SDL	sedež za tuš kabino - višinsko nastavljiv sjedalo za tuš kabino - podesiv po visini (Nosilnost do 110 kg)	3838987 593935	247,00
STK-N				
	STK-N	sedež za tuš kabino z nogicama - preklopni sjedalo za tuš kabino sa nožicama - preklopni (Nosilnost do 110 kg)	3838987 573227	183,00
STK				
	STK	sedež za tuš kabino - preklopni sjedalo za tuš kabino - preklopni (Nosilnost do 110 kg)	3838987 950707	159,00

Kopalniška galanterija Kupaonska galanterija	Program: Vzglavniki		Vzglavniki za kopalne kadi Nasloni za glavu za kupaonske kade	kolpa-san®
Model	Naziv in dimenzija izdelka Naziv i dimenzije produkta	Opis Opis	EAN koda EAN koda	Cena EUR Cijena EUR
HEADREST SOFT				
	HEADREST SOFT	vzglavnik za kopalno kad naslon za glavu, za kade BETTY, DOLORES, LIBRETTO, GAIA, DIVANTE, BEATRICE, CALANDO, NABUCCO, ELEKTRA, SAMSON, TAMIA, PANDORA, DREAM SP	3838987 593942	83,00
HEADREST COAST				
	HEADREST COAST	vzglavnik za vse modele kopalnih kadi naslon za glavu za sve modele kupaonskih kada	3838987 593928	108,00

	Program: Premazi			
ANTI-SLIP PREMAZ				
	ANTI-SLIP PREMAZ	protizdrski premaz za kopalne in tuš kadi iz litega sanitarnega akrila in litega marmorja protiv sklizni premaz za kupaonske i tuš kade od lijevanog mramora i sanitarnog akrila		70,00
		minimalna količina za naručilo je 10 kos posameznega modela minimalna količina za naruđbu je 10 kos posamičnog modela		



Model	Naziv in dimenzija izdelka Naziv i dimenzije produkta	Opis Opis	EAN koda EAN koda	Cena EUR Cijena EUR
Specialno čistilo KOLPA SAN				
	Specialno čistilo KOLPA SAN Specijalno sredstvo	krt = 20 x 0,5 l (Cena za kos / Cijena na komad 6,50 EUR) za odstranjevanje vodnega kamna na kopalnih in tuš kadeh, umivalnikih ter steklih tuš kabin / za odstranjivanje vodnog kamenca na kupaonskim i tuš kadama, umivaonicima i staklima tuš kabina	3838987 747291	130,00
Specialno čistilo ECO SAN				
	Specialno čistilo ECO SAN Specijalno sredstvo	krt = 20 x 0,5 l (Cena za kos / Cijena na komad 5,70 EUR) ekološko čistilo za odstranjevanje vodnega kamna na kopalnih in tuš kadeh, umivalnikih ter steklih tuš kabin ekološko sredstvo za odstranjivanje vodnog kamenca na kupaonskim i tuš kadama, umivaonicima i staklima tuš kabina	3838987 572220	114,00
KOLPA SAN - čistilo za popolno higieno masažnih kadi				
	KOLPA SAN - čistilo za popolno higieno masažnih kadi KOLPA SAN - sredstvo za potpuno higieno masažnih kada	krt = 10 x 1 l (Cena za kos / Cijena na komad 8,20 EUR) čistilo za popolno higieno masažnih kadi Kolpa san Sredstvo za potpuno higieno masažnih kada Kolpa san	3838987 747277	82,00
KERIL - Specialno čistilo za KERROCK				
	KERIL - Specialno čistilo za KERROCK KERIL - Specijalno sredstvo	krt = 12 x 0,5 l (Cena za kos / Cijena na komad 4,50 EUR)	3838987 747307	54,00
Mast za ležaje in tečaje tuš kabin				
	Mast za ležaje in tečaje tuš kabin Mast za ležajeve i šarke tuš kabina	krt = 10 kos x 20 ml (Cena za kos / Cijena na komad 4,70 EUR)	3838987 994169	47,00



kolpa·san

©KOLPA, d.o.o. Metlika, 2023. Vse pravice pridržane. All rights reserved.

Cenik št. 01/2023 za plačilo v EUR.
Cenik velja / cjenik važi od 1.6.2023 do preklica / do opoziva.